



# Viz Engine Administrator Guide

Version 5.3



# Viz Engine



**Copyright** ©2024 Vizrt. All rights reserved.

No part of this software, documentation or publication may be reproduced, transcribed, stored in a retrieval system, translated into any language, computer language, or transmitted in any form or by any means, electronically, mechanically, magnetically, optically, chemically, photocopied, manually, or otherwise, without prior written permission from Vizrt.

Vizrt specifically retains title to all Vizrt software. This software is supplied under a license agreement and may only be installed, used or copied in accordance to that agreement.

### **Disclaimer**

Vizrt provides this publication “as is” without warranty of any kind, either expressed or implied. This publication may contain technical inaccuracies or typographical errors. While every precaution has been taken in the preparation of this document to ensure that it contains accurate and up-to-date information, the publisher and author assume no responsibility for errors or omissions. Nor is any liability assumed for damages resulting from the use of the information contained in this document. Vizrt’s policy is one of continual development, so the content of this document is periodically subject to be modified without notice. These changes will be incorporated in new editions of the publication. Vizrt may make improvements and/or changes in the product(s) and/or the program(s) described in this publication at any time.

Vizrt may have patents or pending patent applications covering subject matters in this document. The furnishing of this document does not give you any license to these patents.

### **Antivirus**

Vizrt does not recommend or test antivirus systems in combination with Vizrt products, as the use of such systems can potentially lead to performance losses. The decision for the use of antivirus software and thus the risk of impairments of the system is solely at the customer's own risk.

There are general best-practice solutions, these include setting the antivirus software to not scan the systems during operating hours and that the Vizrt components, as well as drives on which clips and data are stored, are excluded from their scans (as previously stated, these measures cannot be guaranteed).

### **Technical Support**

For technical support and the latest news of upgrades, documentation, and related products, visit the Vizrt web site at [www.vizrt.com](http://www.vizrt.com).

### **Created on**

2024/12/12



# Contents

<b>1</b>	<b>Introduction to Viz Engine .....</b>	<b>16</b>
1.1	Related Documents.....	16
1.2	Feedback and Suggestions.....	16
<b>2</b>	<b>New in Viz Engine .....</b>	<b>17</b>
2.1	New Particle System .....	17
2.2	Improved PBR Workflow.....	18
2.3	New XR/AR Possibilities .....	18
2.4	Improved Clip Playback.....	18
2.5	NDI 6 & HDR .....	18
2.6	Viz Engine Migration Helper Tool .....	19
2.7	Changed Shortcuts .....	22
2.7.1	Scene Editor .....	22
2.7.2	Render Editor (On Air).....	22
2.7.3	Stage .....	23
<b>3</b>	<b>WIBU Licensing System .....</b>	<b>24</b>
3.1	Important Pre-installation Information.....	25
3.2	Key Features and Workflow of the New Licensing System .....	25
3.3	Limitations and Known Issues.....	26
3.4	Basic Set-up.....	26
3.5	Configuration Settings.....	28
3.5.1	Why Do We Need to Configure the Licenses?.....	28
3.5.2	Configuring the License System in the Viz Engine Configuration UI .....	28
3.5.3	Configuration Entries in the Viz Engine Configuration File.....	28
3.6	WIBU License System.....	33
3.6.1	Summary of Key Concepts in the Licensing System .....	33
3.6.2	WIBU License Share Status.....	33
3.6.3	WIBU Core License Summary .....	34
3.6.4	WIBU Licenses and Their Effect .....	37
3.7	Notes.....	49
3.7.1	Colors used in License Overview .....	49
3.7.2	Starting Viz Engine with WIBU License System .....	50
3.7.3	Starting Viz Engine with DVI OUT .....	50
3.7.4	Starting Viz Engine with MezzIP OUT and/or 1xMezzIP IN .....	51

3.7.5	Starting Viz Engine with NDI OUT and/or NDI IN .....	51
3.7.6	Starting Viz Engine with Frameserver Functionality (MUX Ports).....	51
3.7.7	Starting Viz Engine with SDI/IP OUT or SDI/IP IN .....	52
3.7.8	Starting Viz Engine with Viz Artist.....	52
3.7.9	Starting Viz Engine with Unreal Integration (Vizrt Media for Unreal Engine).....	52
3.7.10	Using DSX Core Licenses.....	52
3.7.11	Permanent Licenses.....	52
3.8	Setup Graphic Hub Journal-based E-Mail Notifications .....	53
3.9	Setup Redundancy for a WIBU License Server .....	53
3.9.1	Set Up Redundancy for a WIBU License Server .....	53
3.9.2	Test License Server Failover .....	53
3.9.3	Recover First License Server.....	53
3.9.4	Notes.....	49
<b>4</b>	<b>Security Advisor .....</b>	<b>55</b>
4.1	Recommendations.....	55
<b>5</b>	<b>Software Configuration .....</b>	<b>56</b>
5.1	Prerequisites .....	57
5.1.1	Supported Operating Systems .....	57
5.1.2	Virtual Environments .....	58
5.1.3	Environment Settings .....	59
5.1.4	Hardware and BIOS Settings .....	59
5.1.5	Power Management Settings .....	59
5.1.6	User Rights.....	60
5.1.7	Secure Boot .....	60
5.1.8	Setting Permissions to Run Viz Engine and Viz Artist .....	60
5.1.9	Anti-Virus Software .....	62
5.1.10	Additional Prerequisites .....	62
5.2	Viz Artist and Viz Engine Installation .....	63
5.2.1	Installing Viz Artist and Engine .....	63
5.2.2	Upgrading from a Previous Installation .....	65
5.2.3	To Change or Reinstall an Existing Installation .....	66
5.2.4	Silent Installation of Viz Artist and Engine .....	66
5.2.5	Installation of a Specific Component.....	66
5.2.6	Unattended Installation of Viz Artist and Engine .....	67
5.2.7	To Identify Installed Version.....	71
5.3	Viz Engine Folders .....	72
5.3.1	Installation Folders .....	72

5.3.2	Data Folders .....	72
5.4	Ports and Connections .....	73
5.4.1	Port Numbers .....	73
5.4.2	Multiplexing Ports .....	80
5.5	Viz Log Files .....	81
5.5.1	Viz Render Log .....	81
5.5.2	Viz Trace Log .....	81
5.5.3	Viz Gui Log .....	81
5.5.4	Viz Shaders Log .....	82
5.5.5	Viz Console Log .....	82
5.5.6	Viz GUI Connection Log .....	82
5.5.7	Create Log Files with Log and Clog Commands .....	82
5.6	Logfiles Configuration .....	83
5.6.1	Location of Log Configuration .....	83
5.6.2	Concept of Log Configuration .....	83
5.6.3	Built-In Log Config .....	89
5.6.4	Examples .....	93
5.7	Supported Software .....	96
5.7.1	Viz Engine Software .....	96
5.7.2	Preview Server .....	96
5.7.3	Viz Artist Software .....	97
5.8	Import and Export Formats .....	98
5.8.1	EXIF .....	98
5.9	Viz Engine REST Interface .....	99
5.10	User Account Control .....	100
5.11	NDI .....	101
5.11.1	NDI Input .....	101
5.11.2	NDI Output .....	102
5.11.3	NDI in Software I/O Only Mode .....	102
5.11.4	SDK Versions .....	102
5.12	Dual Channel Mode .....	104
5.12.1	To Configure Dual Channel .....	104
5.13	Trio Box CG Mode .....	107
5.13.1	To Configure Trio Box CG .....	107
5.14	Dolby E Support .....	110
5.14.1	Dolby E Features .....	110
5.14.2	Dolby E Configuration .....	111

5.15	EVS Video Server Control.....	112
5.15.1	Setup Requirements .....	112
5.15.2	RS422 and XtenDD35 Configuration.....	112
5.15.3	RS422 Pin-out for the Connector Cable .....	113
5.15.4	RS422 Controller Set Up Examples .....	113
5.15.5	Bluestorm LP PCI Card Configuration.....	113
5.15.6	ExSys EX-1303 USB to RS422 Connector Configuration .....	113
5.16	Integration with Viz One .....	115
5.16.1	Configure Viz Engine .....	115
5.16.2	Install Transfer and Monitor Services on Viz Engine .....	115
5.16.3	To Configure Viz One.....	117
5.16.4	Configure Local Preview of Video Files .....	117
5.17	Matrox Stream.....	118
5.17.1	Matrox License .....	119
5.17.2	Example Matrox License Configuration .....	120
5.17.3	Output Mode .....	120
5.17.4	Configuring a Stream .....	121
5.17.5	Example Sending MPEG-TS over RTP and Receiving with Viz Engine on localhost.....	122
5.17.6	Example Receiving MPEG-TS over UDP on localhost .....	122
5.17.7	Example Receiving SRT on localhost .....	123
5.17.8	Example Receiving RTSP on localhost.....	123
5.17.9	Example Receiving RTMP on localhost .....	124
5.17.10	More Advanced Example Using ffmpeg .....	124
5.17.11	Receiving Different Input Types .....	125
5.17.12	Limitations .....	125
5.17.13	Known Issues and Troubleshooting.....	125
5.18	VML Clip Player.....	126
5.18.1	Feature Comparison between Clip Players .....	126
5.18.2	Mixed Resolution Mode in Matrox and VML Clip Player .....	128
5.18.3	Non-broadcast Clip Support in Matrox and VML Clip Player .....	133
5.18.4	VML Clip Player as a Fallback Clip Player.....	134
5.18.5	Clip Player AutoFormat.....	135
5.18.6	VML Clip Player with NVDEC .....	135
6	Hardware Related Information .....	136
6.1	Handling and Installing Cards .....	137
6.2	Graphics Boards .....	138
6.2.1	NVIDIA Driver Configuration .....	139

6.2.2	Supported GPUs and Driver History.....	145
6.2.3	Virtualized GPUs.....	148
6.2.4	Working with Synchronous Output.....	153
6.2.5	Working with Two or More GPUs.....	155
<b>6.3</b>	<b>Supported Systems.....</b>	<b>156</b>
6.3.1	Dell R7920.....	157
6.3.2	HP Z4 G4.....	160
6.3.3	HP Z4 G5.....	163
6.3.4	HP Z4 Rack G5.....	167
6.3.5	HP Z8 G4.....	169
6.3.6	HP Z8 G5 Fury.....	174
6.3.7	HP ZCentral 4R.....	178
6.3.8	Lenovo P3 Ultra.....	181
6.3.9	Lenovo P620.....	183
6.3.10	Lenovo SR655 V3.....	186
<b>6.4</b>	<b>Video Boards.....</b>	<b>188</b>
6.4.1	SMPTE ST 2110 Configuration.....	189
6.4.2	Matrox Hardware.....	204
6.4.3	BlueFish444.....	257
6.4.4	Aja Hardware.....	268
<b>7</b>	<b>Starting Viz Engine.....</b>	<b>273</b>
7.1	To Start Viz Engine.....	273
7.2	To Add a Viz Engine Startup Option.....	273
7.2.1	Viz Configuration.....	273
7.2.2	To Migrate a Previous Viz Configuration.....	274
7.2.3	Deleting Shader Cache.....	274
7.3	Viz Console.....	275
7.3.1	Autocompletion Feature.....	275
7.3.2	Issuing External Commands to Viz Engine via Console.....	276
7.3.3	Internal Commands.....	278
7.4	Viz Command Line Options.....	280
7.4.1	Systems with Two or More GPUs.....	282
<b>8</b>	<b>Configuring Viz.....</b>	<b>284</b>
8.1	Working with Viz Configuration.....	285
8.1.1	To Start Viz Configuration.....	285
8.2	Modify Viz Configuration.....	285
8.2.1	To Save the Current Configuration.....	285

8.2.2	To Reset the Viz Config File.....	285
8.2.3	To Restart Viz Configuration.....	285
8.3	Installed Configuration Profiles .....	286
8.3.1	To Load a Pre-Installed Configuration Profile .....	286
8.3.2	To Save a Custom Profile .....	286
8.3.3	To Load a Custom Configuration Profile.....	286
8.4	Audio Settings .....	287
8.4.1	Various Tab.....	287
8.4.2	Channels Tab.....	288
8.4.3	Manual Audio Configuration.....	290
8.5	Authentication .....	292
8.5.1	Authentication Properties .....	292
8.6	Camera .....	295
8.6.1	Camera Properties .....	296
8.7	Clock Formats .....	298
8.8	Communication .....	299
8.8.1	Global Properties .....	299
8.8.2	Shared Memory Properties.....	302
8.8.3	VDCP Properties .....	303
8.9	Database.....	305
8.9.1	Global Properties .....	305
8.9.2	Failover Properties.....	307
8.9.3	Deploy.....	307
8.10	Font Text Options.....	309
8.10.1	Classic .....	309
8.10.2	Viz Engine .....	310
8.11	Global Input.....	311
8.11.1	To Synchronize Multiple Viz Engines.....	311
8.12	Image File Name Convert .....	312
8.13	Import 3D Options.....	313
8.14	Local Settings .....	314
8.14.1	Select Multiple Directories.....	315
8.14.2	SAM SDC01, SDC02, and SDC03 Protocols .....	315
8.15	Maps.....	317
8.15.1	To Add the VizWorld.ini File.....	318
8.16	Matrox.....	319
8.16.1	General Properties .....	319

8.16.2	VideoOut Properties.....	320
8.16.3	M264 Encoder/Decoder Boards.....	323
8.17	Memory Management .....	324
8.18	Output Format .....	326
8.18.1	UHD TV Support .....	327
8.18.2	Adaptive Scene Design.....	327
8.19	Path Aliases .....	328
8.19.1	To Add a Path .....	328
8.20	Plug-ins.....	330
8.20.1	Plugin Directories.....	330
8.20.2	Plug-in Panel List .....	330
8.21	Render Options .....	332
8.22	Scene Default Values.....	336
8.22.1	Media Asset Configuration.....	337
8.23	Spaceball .....	339
8.24	Unreal Engine .....	341
8.24.1	Start/Close Unreal Engine using Viz Engine in On Air Mode .....	342
8.25	User Interface .....	343
8.25.1	Various .....	343
8.25.2	Tree Colors .....	345
8.25.3	Shortcuts .....	346
8.26	Video Board .....	349
8.26.1	Video Board Properties.....	349
8.26.2	Clip Input Properties.....	351
8.26.3	Clip Input Properties.....	351
8.27	Video Input: Clip Input .....	352
8.27.1	Clip Input Properties.....	352
8.28	Video Input: Live Input.....	354
8.28.1	Live Input Properties: Type SDI .....	355
8.28.2	Live Input Properties: Type IP .....	356
8.28.3	Live Input Properties: Type STREAM .....	357
8.28.4	Live Input Properties: Type NDI.....	358
8.28.5	Live Input Properties: Type SHM - SMURF .....	358
8.28.6	Mapping of Legacy StreamIn Channels.....	358
8.29	Video Output .....	359
8.29.1	Video Output Properties .....	359
8.29.2	Video Output Editor .....	359

8.30	Video Output: Clip Output .....	361
8.30.1	To Configure Clip Output .....	361
8.30.2	Clip-out Channel Placeholders.....	362
8.30.3	Sample Commands.....	362
8.31	Video Output: SHM Output .....	365
8.32	Viz License Configuration .....	366
8.33	Viz One .....	368
8.33.1	Viz One Properties.....	369
<b>9</b>	<b>On Air Mode .....</b>	<b>372</b>
9.1	Director Control Pane .....	373
9.2	Control Buttons.....	374
9.3	Performance.....	376
9.3.1	Performance Monitor.....	376
9.3.2	Renderer Overlays.....	377
9.4	On Air Information Panel .....	379
9.4.1	Basic Tab .....	379
9.4.2	Clients Tab.....	380
9.5	License Information .....	381
<b>10</b>	<b>Video IO Configuration and Features.....</b>	<b>382</b>
10.1	Basic IO Configuration .....	383
10.1.1	General Information.....	383
10.1.2	Clip Input Channels.....	384
10.1.3	Live Input Channels .....	384
10.2	High Dynamic Range .....	386
10.2.1	Introduction .....	386
10.2.2	HDR Support in Viz Engine with Matrox Boards .....	387
10.2.3	How to Configure HDR.....	388
10.2.4	HDR Support in Viz Engine with NDI.....	389
10.2.5	How to Configure HDR with NDI .....	389
10.3	Mixed Mode Video Support.....	391
10.3.1	Source: PAL or NTSC .....	391
10.3.2	Source: 720p.....	392
10.3.3	Source: 1080i .....	393
10.4	Frame Accurate Output .....	396
10.4.1	FAO Prerequisites.....	397
10.4.2	Commands .....	398



10.4.3	General Purpose IO Commands .....	399
10.4.4	Timed Command Execution .....	403
10.5	Shared Usage of Input Channels .....	406
10.5.1	Configuration .....	406
10.5.2	Important .....	406
10.5.3	Sharing Inputs on X.mio5 ST 2110 Boards .....	406
10.6	Dynamic Channel Allocation .....	407
10.6.1	Limitations .....	407
10.7	Matrox Supported Codecs .....	408
10.8	DVE Performance .....	409
10.8.1	General Information.....	409
10.8.2	X.mio5.....	409
10.8.3	X.mio3.....	410
10.9	Watchdog.....	412
10.9.1	Mechanical Bypass.....	412
10.9.2	Hardware Bypass .....	412
10.9.3	Transition from Watchdog to Video .....	412
10.10	NDI Output from GFX Channel.....	413
10.10.1	Configuration .....	413
10.10.2	Operation .....	413
10.11	Clip Player Pro Features.....	415
10.11.1	H.265.....	415
10.11.2	HAP .....	415
10.11.3	GPU Hardware Acceleration / NVDEC .....	415
<b>11</b>	<b>SMPTE 2110 Information .....</b>	<b>417</b>
11.1	General Information and Introduction .....	418
11.1.1	General Description .....	418
11.1.2	Standards .....	418
11.1.3	Definition of Terms .....	420
11.2	Configuring a Static Network .....	423
11.2.1	What is a Static IP Setup .....	423
11.2.2	Examples .....	423
11.3	Working with NMOS .....	425
11.3.1	What is NMOS .....	425
11.3.2	A Typical NMOS Environment.....	425
11.3.3	How to Configure NMOS on Viz Engine Systems .....	425
11.4	Troubleshooting SMPTE ST2110 and NMOS.....	427

11.4.1	Known Issues.....	427
11.4.2	SMPTE ST 2110 .....	427
11.4.3	NMOS .....	430
11.5	Explicit Usage of the Second SFP Pair on Matrox X.mio5 Q25 .....	431
11.5.1	Examples .....	431
<b>12</b>	<b>Audio in Viz Engine .....</b>	<b>432</b>
12.1	Overview .....	433
12.1.1	Channels.....	433
12.1.2	Matrox Routing.....	434
12.1.3	DirectShow .....	434
12.2	Device Recognition and Selection.....	436
12.3	Timing Behavior and Delay Settings .....	437
12.3.1	Latency Adjustment on the DirectSound Audio Device .....	437
12.4	Audio Plug-in .....	440
12.5	Clip Formats .....	441
12.6	Speaker Names .....	442
12.7	Emergency Alert System.....	443
12.7.1	To Specify Output Channels for EAS .....	443
12.8	Shared Memory Integration of Channel Volume Levels.....	444
12.9	Dolby E Configuration .....	446
12.9.1	Enable DolbyE .....	446
12.9.2	Prepare for DolbyE Decoding .....	446
12.9.3	Prepare for DolbyE Encoding .....	447
12.9.4	Decode Plus Encode .....	447
12.9.5	Pass-through Mode.....	447
12.10	Channel Setup and Clip Channel Routing.....	449
12.10.1	To Test Audio Channel Setup .....	449
12.11	Matrox Audio .....	450
12.11.1	To Enable Matrox Audio.....	450
<b>13</b>	<b>Viz Engine Shared Memory .....</b>	<b>451</b>
13.1	Viz Engine SHM Synchronization.....	452
13.1.1	TCP and UDP Synchronization .....	452
13.1.2	External Control Synchronization .....	453
13.1.3	Command Synchronization.....	454
13.2	Viz Engine SHM External Data Input.....	455
13.2.1	SHM over TCP .....	456

13.2.2	SHM over UDP .....	457
13.2.3	Plug-in API .....	458
13.3	Viz Engine Internal Data Interactive Scene .....	460
13.3.1	Example .....	460
13.4	Viz Engine SHM Snapshot .....	461
<b>14</b>	<b>Video Wall Configuration .....</b>	<b>462</b>
14.1	Hardware Requirements and Recommendations.....	463
14.1.1	Minimum Hardware Configuration for Video Walls.....	463
14.1.2	Recommended Configuration for Video Walls .....	463
14.1.3	UHD Configuration with X.mio5 Boards.....	464
14.1.4	IP-based Video Walls.....	464
14.2	Performance Considerations.....	465
14.2.1	Hardware Considerations.....	465
14.2.2	Clip Playback .....	465
14.2.3	Scene Design Considerations .....	466
14.3	Troubleshooting Video Wall Configurations.....	467
14.3.1	Performance Issues.....	467
14.3.2	Steps to Recover from Severe NVIDIA Mosaic Driver Related Issues .....	467
14.3.3	Experiencing BSOD or System Freeze while Setting up Mosaic.....	468
14.3.4	Only Some Displays of the Video Wall display an Image.....	468
14.3.5	Missing NVIDIA Control Panel Settings.....	468
14.3.6	NVIDIA Control Panel Crashes .....	468
14.3.7	Mosaic Configuration Not Supported Error .....	469
14.3.8	G-Sync Status LEDs or Topology Reports Indicate a Synchronization Issue .....	469
14.3.9	Poor Performance when Using GFX Channels as DVE .....	469
14.3.10	Jittering on HP Z840 .....	470
14.3.11	Other Synchronization Issues.....	470
14.4	HDR Window Configuration.....	471
14.4.1	Introduction .....	471
14.4.2	Prerequisites .....	471
14.4.3	Configuration .....	471
14.4.4	References.....	472
14.5	Video Wall Setup Instructions .....	473
14.5.1	Pre-Requirements for All Setups .....	474
14.5.2	Configure the NVIDIA Driver for Video Wall.....	475
14.5.3	Order of Steps to Set Up NVIDIA Mosaic.....	475
14.5.4	NVIDIA Quadro Sync.....	476

14.5.5	Configuration Using Datapath Devices .....	477
14.5.6	NVIDIA Mosaic Configuration for 1080i50 .....	482
14.5.7	NVIDIA Mosaic Configuration for 1080i60M .....	489
14.5.8	Custom Resolution for 59.94 Hz Refresh Rate .....	493
14.5.9	Viz Engine Video Wall Configuration Settings.....	498
<b>15</b>	<b>SNMP Support .....</b>	<b>501</b>
15.1	Introduction .....	501
15.2	Installation .....	501
15.2.1	Prerequisites .....	501
15.2.2	To Install the Services .....	501
15.2.3	Installation .....	503
15.2.4	Configuration .....	503
15.2.5	Viz Engine Specific Settings.....	504

This Administrator Guide gives details on the configuration and installation of Viz Engine. It also explains settings available through its configuration user interface.

The term Viz is used for the programs installed and run on the computer. This is used as a general reference for all modes of the program:

- Viz Artist (see the [Viz Artist User Guide](#))
- Viz Engine
- Viz Configuration

---

# 1 Introduction To Viz Engine

This Administrator Guide gives details on the configuration and installation of Viz Engine. It also explains settings available through its configuration user interface.

The term Viz is used for the programs installed and run on the computer. This is used as a general reference for all modes of the program:

- Viz Artist (see the [Viz Artist User Guide](#))
- Viz Engine
- Viz Configuration

What mode of program that can run is determined from the hardware dongle that is attached to the actual machine (the different modes and the hardware dongle are detailed in this User Guide).

---

## 1.1 Related Documents

- *Viz Artist User Guide*: Contains information on how to install Viz Engine and create graphics scenes in Viz Artist.
  - *Viz Artist Script Reference*: Contains information on how to create scripts for a scene.
  - *Viz Engine Plug-in SDK Reference*: Contains information on how to create a customized Viz plug-in.
- 

## 1.2 Feedback And Suggestions

We encourage suggestions and feedback about our products and documentation. To give feedback and/or suggestions, please contact your local Vizrt customer support team at [www.vizrt.com](http://www.vizrt.com).

---

## 2 New In Viz Engine

Viz Engine/Viz Artist  
Version 5.3

WHAT'S  
NEW?

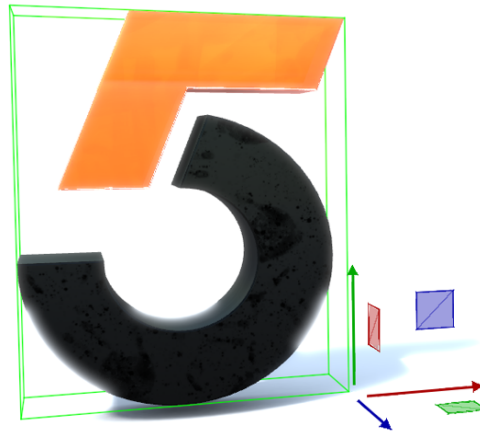

Viz Artist 5 introduced a significantly enhanced user experience. An all-new Scene Tree benefits users with improved accessibility and navigation within Scene Tree Containers.

New versions of Layer Manager and Scene Overview panel were included, plus IES Lighting and Adaptive Scene Design (which intelligently adjusts pre-defined output formats on the fly) are just some of the new features of Viz Artist 5.

The latest release, Viz Artist 5.3, delivers an improved user experience driven by a modern state-of-the-art user interface, coupled with an increase in application performance and several new features.

---

### 2.1 New Particle System



Viz Engine 5.3 introduces the first iteration of a GPU accelerated Particle Effects System.

At introduction, Fire and Smoke are offered (with modifiers available, such as Wind, Turbulence, and Gravitation).

Third-party Particle Effect System plug-ins will also be possible via API.  
[Read more...](#)

## 2.2 Improved PBR Workflow

When a set of images is imported, Viz Artist 5.3 detects if a PBR material can be generated. If matching images are detected, Viz Artist automatically creates the material, saving time and improving workflows.

Viz Artist users can now drag ZIP files into the Viz Artist GUI and files automatically expand and import into Graphic Hub. Read more....



## 2.3 New XR/AR Possibilities



AR elements are defined and more easily visualized within a Scene as layers in front of virtual set extensions, the video wall, and the talent. Users benefit from this simplified XR workflow when implementing AR graphics and virtual set extensions adjacent to video walls.

Within Virtual Set use cases, users have the option to dedicate a GPU to Unreal Engine, while Viz Engine maintains the capability to run on a separate GPU.

Performance is increased across the workflow and Scenes can be optimized efficiently.

## 2.4 Improved Clip Playback

With the new container based Clip Player implementation, Viz Engine Render offers a new alternative to the Softclip solution in the Classic Render Pipeline while supporting most common codecs.

A switch to GPU-based hardware acceleration with NVDEC (NVIDIA Decoder) significantly enhances Clip Player Pro performance.



## 2.5 NDI 6 & HDR



Support for NDI 6 has been added to Viz Engine 5.3 and includes support for HDR HLG workflows on input and output.

HDR S-Log3 is added, as is support for HDR displays and HDR video walls – as managed through the HDR feature within Microsoft Windows OS.



---

## 2.6 Viz Engine Migration Helper Tool

Many Viz Engine users are operating on legacy Viz Engine 3.x and Viz Engine 4.x hardware and software. This is severely limiting their ability to implement modern and efficient graphics workflows. One reason given for the delay is that they operate with very large graphic libraries and therefore must contend with time and resource constraints.

Viz Engine 5.3 introduces a 'Classic Render Pipeline' Viz Engine Renderer Migration Helper Tool that will save many hours of effort to migrate and convert large graphic libraries to the new and more powerful Viz Engine Renderer. [Read more....](#)

Viz Engine	Viz Artist	Integrations
<ul style="list-style-type: none"> <li>• Classic – Viz Engine Render Pipeline migration helpers</li> <li>• NDI 6 Support + HDR HLG workflows</li> <li>• HDR S-Log3 Support</li> <li>• Clip Player Pro – GPU Hardware Acceleration</li> <li>• Container/Scene-based clip playback for Viz Engine Render Pipeline</li> <li>• Matrox DSX LE 5 SDI LP Support</li> <li>• Support RTX 4500 Ada and RTX 5000 Ada</li> <li>• New Audio Backend</li> <li>• Parallel Output Additions               <ul style="list-style-type: none"> <li>• Matte Scene Output</li> <li>• Precision Keyer Preview/Aux Output</li> </ul> </li> <li>• Improved IO delay handling and configuration</li> <li>• Frameserver Core</li> <li>• Quick Presets</li> <li>• Viz Engine Render Pipeline Improvements               <ul style="list-style-type: none"> <li>• Particle System</li> <li>• Limited Front- and Back- Layer compatibility mode</li> <li>• Multi-Layer XR Set sequence to render Set Extension + AR objects</li> <li>• Interactive XR Line drawing tool to combine with Reality Connect or trackers</li> <li>• Plug-in API                   <ul style="list-style-type: none"> <li>• Compute Shader Support</li> </ul> </li> </ul> </li> </ul>	<ul style="list-style-type: none"> <li>• Improved image import for PBR Materials</li> <li>• Option to apply color coding to entire container</li> <li>• Configurable Shortcuts for Viz Artist and Viz Engine</li> <li>• Color schema for Live Input sources</li> <li>• Switching active Graphic Hub without restart</li> <li>• New Undo/Redo Stack</li> <li>• Examples for Vertex-, Fragment- and Transition-Shaders</li> <li>• Favorites for Fontfaces</li> <li>• New modern Icon Set</li> </ul> <div data-bbox="603 1039 997 1146" style="border: 1px solid #ccc; border-radius: 10px; padding: 10px; margin-top: 20px;"> <p> <a href="#">See list of changed shortcuts</a></p> </div>	<ul style="list-style-type: none"> <li>• Unreal Engine               <ul style="list-style-type: none"> <li>• UE 5.4 Support</li> <li>• Multi GPU Support to distribute load for Viz Engine and UE</li> <li>• Multi-Layer External VS render sequence</li> </ul> </li> </ul>

Viz Engine	Viz Artist	Integrations
<ul style="list-style-type: none"><li>• Buffer Objects (Compute Shaders, Instancing)</li><li>• Runtime/Plug-in Material Shadow and Picking</li><li>• Hot-reloading of textures</li><li>• Shadow Light</li><li>• Scene View additions (disable self draw)</li><li>• HDR Window/Context creation for HDR displays</li><li>• Interactivity support from Classic Render Pipeline</li><li>• Improved Media Asset Compositing (blending against background color, antialiasing artifacts)</li><li>• Preparation for Viz Libero Support</li><li>• Newly supported Plug-ins:<ul style="list-style-type: none"><li>• Text FX Write</li><li>• Temo</li><li>• DataPool Countdown</li><li>• Extended Control Text feature set</li></ul></li><li>• Viz Script<ul style="list-style-type: none"><li>• New callback functions</li></ul></li></ul>		

Viz Engine	Viz Artist	Integrations
<ul style="list-style-type: none"> <li>• Access Material Definition Plug-in Instance</li> <li>• Security Upgrades</li> </ul>		

## 2.7 Changed Shortcuts

The following shortcuts have changed:

### 2.7.1 Scene Editor

Action	Old Shortcut	New Shortcut
Delete Object	<b>BACKSPACE</b>	Added <b>DELETE</b> as additional shortcut
Camera View Zoom	<b>X/Z</b> or ( <b>O</b> + Mouse Wheel)	<b>X/Z</b> or (Mouse Wheel)
Orthogonal Rubberband Zoom	<b>X/Z</b> + Mouse Drag	<b>Q/W</b> + Mouse Drag
Switch to Back Camera (Orthogonal)	Keypad <b>0</b>	Keypad <b>1</b>
Mouse Position/Rotate/Scale (Undocumented and Classic only)	<b>X/Y/Z</b> Key + Mouse Wheel	Removed

### 2.7.2 Render Editor (On Air)

Action	Old Shortcut	New Shortcut
Off Air	<b>ESC</b>	Added <b>CTRL + Q</b> as additional shortcut
Toggle Preview	<b>SHIFT + BACKSPACE</b>	Added <b>CTRL + P</b> as additional shortcut

### 2.7.3 Stage

Action	Old Shortcut	New Shortcut
Select Keyframes	<b>S</b> + Mouse Drag	<b>R</b> + Mouse Drag
Set Stoppoint	<b>S</b> + Mouse Click on Director	<b>P</b> + Mouse Click on Director
View Spline 1/2/3	<b>CTRL Z/X/C</b>	<b>1/2/3</b>

---

## 3 WIBU Licensing System

This chapter describes management and usage of the licensing system based on CodeMeter from [WIBU Systems](#) available in Viz Engine 3.10 and later. It replaces the previous VALID/Sentinel/Hardlock Dongle licensing system and allows Viz Engine to be used without a physical dongle on each machine, by allocating licenses from a license server on the network.

This section contains the following information:

- [Important Pre-installation Information](#)
- [Key Features and Workflow of the New Licensing System](#)
- [Limitations and Known Issues](#)
- [Basic Set-up](#)
- [Configuration Settings](#)
  - [Why Do We Need to Configure the Licenses?](#)
  - [Configuring the License System in the Viz Engine Configuration UI](#)
  - [Configuration Entries in the Viz Engine Configuration File](#)
    - [WIBU Additional Licenses for Engine Core License ENG\\_ENG\\_CORE](#)
    - [WIBU Additional Licenses for Core License ENG\\_PRV\\_CORE](#)
    - [WIBU Additional Licenses for Core License ENG\\_FRAMESERVER\\_CORE](#)
    - [WIBU Additional Licenses for Viz Libero Core License](#)
    - [WIBU Additional Licenses for Viz Arena Core License](#)
    - [WIBU Additional Licenses for Viz Eclipse Core License](#)
- [WIBU License System](#)
  - [Summary of Key Concepts in the Licensing System](#)
  - [WIBU License Share Status](#)
  - [WIBU Core License Summary](#)
  - [WIBU Licenses and Their Effect](#)
- [Notes](#)
  - [Colors used in License Overview](#)
  - [Starting Viz Engine with WIBU License System](#)
  - [Starting Viz Engine with DVI OUT](#)
  - [Starting Viz Engine with MezzIP OUT and/or 1xMezzIP IN](#)
  - [Starting Viz Engine with NDI OUT and/or NDI IN](#)
  - [Starting Viz Engine with Frameserver Functionality \(MUX Ports\)](#)
  - [Starting Viz Engine with SDI/IP OUT or SDI/IP IN](#)
  - [Starting Viz Engine with Viz Artist](#)
  - [Starting Viz Engine with Unreal Integration \(Vizrt Media for Unreal Engine\)](#)
  - [Using DSX Core Licenses](#)
  - [Permanent Licenses](#)
- [Setup Graphic Hub Journal-based E-Mail Notifications](#)
- [Setup Redundancy for a WIBU License Server](#)
  - [Set Up Redundancy for a WIBU License Server](#)
  - [Test License Server Failover](#)
  - [Recover First License Server](#)
  - [Notes](#)

### 3.1 Important Pre-Installation Information

The WIBU licensing system requires the installation of the CodeMeter Runtime Software (included in the Bundle installer):

WIBU Runtime	Viz Engine Version
8.10a	5.3 or newer
7.60a	5.1, 5.2
7.40	4.4.1, 5.0
7.21a	4.3
7.20	4.1
6.80	3.12.1
6.60a	3.10.0 - 3.12.0

When the license should be retrieved from a dedicated license server, it must be configured in the Vizrt Licensing Service (see **Client Configuration** page in the **License Server Setup and Administration** section of the [Vizrt Licensing Administrator Guide](#)) or the CodeMeter WebAdmin.

**Information:** There is an auto discovery if no license server is configured in the server search list of CodeMeter.

**Information:** On network disconnect and reconnect, it may happen that a license is checked out twice. In this case, it must be released manually on the CodeMeter service on the license server or the license server can be restarted.

**Note:** Prior to upgrading any version it is highly recommended to create a backup of the Viz Engine configuration files located in: `%PROGRAMDATA%\vizrt\VizEngine`.

### 3.2 Key Features And Workflow Of The New Licensing System

- **Warning:** The VALID/Sentinel/Hardlock Dongle is no longer supported for Viz Engine 4.0.0 and later versions.
- Dongle-less operation on clients with monitoring and logging capabilities.
- Grace periods for allocated licenses to avoid immediate expiration on network or service interruptions.
  - In Viz Engine 4.0.0/3.14.1 or newer license errors are logged to the Graphic Hub journal (see [here how to enable E-Mails](#)).

- Logs license errors (any grace state or if expired) to the Graphic Hub journal as dedicated log messages with level 820.
  - Logs warnings two weeks and every hour prior to license expiration as dedicated Graphic Hub journal message with level 920.
  - Configurable WIBU license container location (any local container, any network container or a dedicated container).
  - Configurable licenses to consume.
  - Viz Artist/Viz Engine startup was changed and no startup helpers are needed anymore (.cmd files, started executables).
  - When a core license cannot be allocated on startup Viz Engine starts in configuration mode.
  - When an additional license fails to allocate on startup an error is logged and the required feature keeps disabled on startup.
- 

### 3.3 Limitations And Known Issues

- All additional licenses consumable to a core license must come from the same container as the core license.
  -  Matrox DSX.Core installer corrupts an existing CodeMeter Runtime installation and causes a crash on Viz Engine startup.
    - Uninstall any CodeMeter Runtime prior to installing Matrox DSX.Core. Install DSX.Core and afterwards install Viz Engine and the newer CodeMeter Runtime.
  - For a preview in TRIO and Pilot as Engine Core, a DVI OUT license is needed.
  - Configuration of licenses requires to start Viz Engine in configuration mode with the configuration UI.
  - In Viz Engine 3.12.1 and newer, the configuration UI works without a valid license and can be configured through the configuration UI.
    - In Viz Engine 3.12.0 and older, the configuration UI only works with a valid license, which depends on the configuration. If no proper license is available then a manual edit of the corresponding configuration entries is required. See [Configuration Entries in the Viz Engine Configuration File](#).
    - By default, the WIBU licensing system with Engine Core license (ENG\_ENG\_CORE) is used when no configuration exists.
  - File-based local WIBU licenses on server operating systems (terminal server) cannot be used via remote desktop connections. For example, if you have installed Windows 10 the access via remote desktop connection works but not, for example, with a Windows Server 2016 system.
  - Viz Engine Startup may take long when network communication has high latency or bandwidth is limited. Workaround for now is to use a license server on a local network.
  - Security groups respective Firewalls on Cloud providers might need to be configured to allow UDP traffic on port `22350` to reach and consume licenses from a license server.
- 

### 3.4 Basic Set-Up

To set up Viz Artist/Viz Engine licensing with WIBU:

1. Install Viz Artist/Viz Engine with the bundle installer (see [Viz Artist and Viz Engine Installation](#)).
2. Configure CodeMeter with the [Vizrt Licensing Service](#) or the CodeMeter WebAdmin (can be opened from the CodeMeter Control Center).



3. Configure the license system in Viz Engine by starting in configuration mode and navigate to **Viz Licenses**.

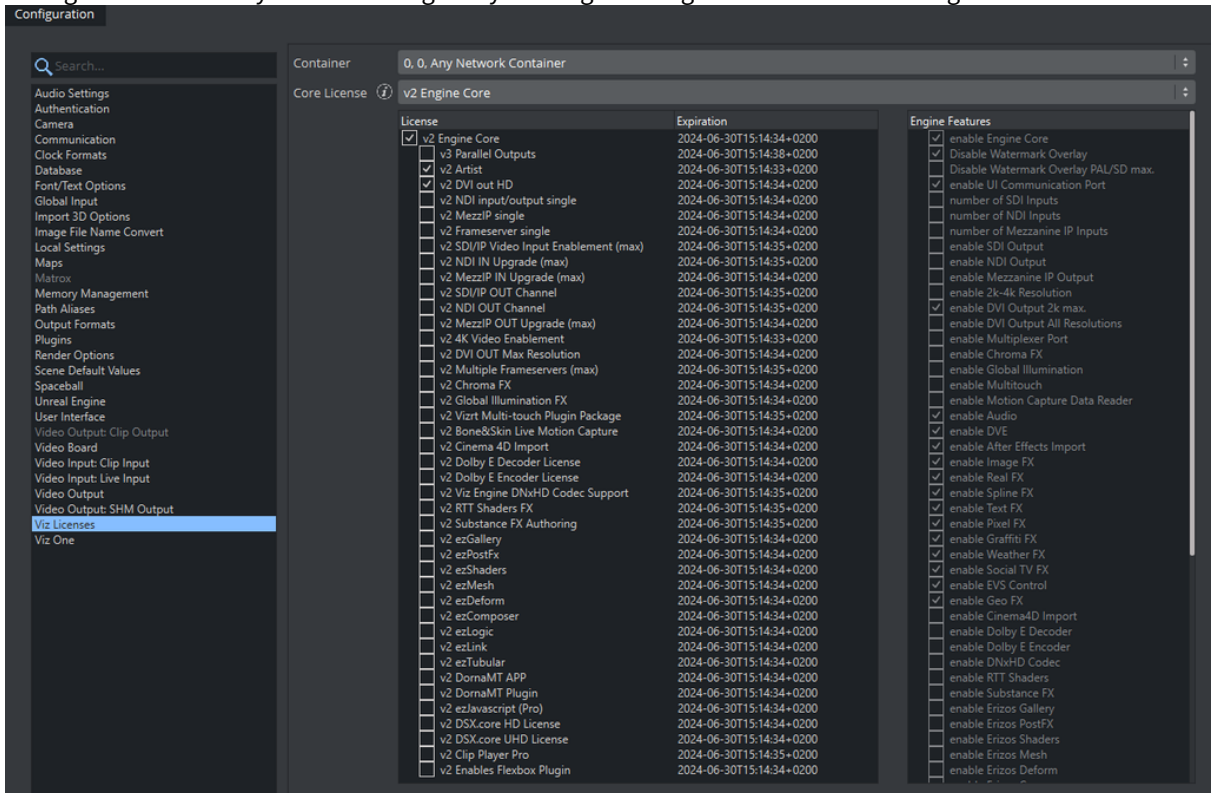

- a. When using any WIBU network container (license server):
  - i. Open the CodeMeter WebAdmin and add the license server to the server search list:

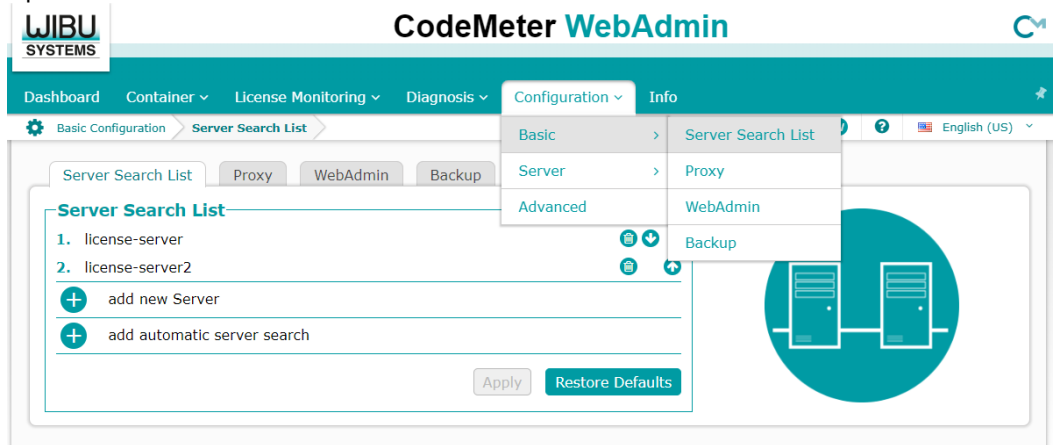

- ii. In the configuration UI under **Viz Licenses** set **Container** to `0,0 Any Network Container` or in the Viz Engine configuration file set `License_Containers = 0,0,1`.
    - iii. Configure the core license and any additional licenses. In the configuration UI under **Viz Licenses** configure **Core License** and **Additional Licenses** or in the Viz Engine configuration file configure `License_Core` and `Additional_Licenses`.
  - b. When using any local WIBU container (dongle, file):
    - i. In the configuration UI under **Viz Licenses**, set **License Location** to `0,0 Any Local Container` or in the Viz Engine configuration file set `License_Containers = 0,0,0`

- ii. Configure the core license and any additional licenses. In the configuration UI under **Viz Licenses**, configure **Core License** and **Additional Licenses** or in the Viz Engine configuration file configure `License_Core` and `Additional_Licenses`.
  - c. When using a dedicated WIBU container (with full container identifier):
    - i. In the configuration UI under **Viz Licenses**, set **License Location** to a specific container (for example, `130,3910158968 Network license`) or in the Viz Engine configuration file set `License_Containers = 13 0,3910158968,1`
    - ii. Configure the core license and any additional licenses. In the configuration UI under **Viz Licenses**, configure **Core License** and **Additional Licenses** or in the Viz Engine configuration file configure `License_Core` and `Additional_Licenses`.
4. Start Viz Engine.

## 3.5 Configuration Settings

### 3.5.1 Why Do We Need to Configure the Licenses?

- Prevent license theft by instances on other nodes or instances on the same node. Licenses are in one container and have a count.
- Several licenses may enable the same feature. There is no one to one mapping of application feature to a single license possible. For example, with multiple instances on one node (Trio One Box), it is important which instance consumes which license for proper operation (first needs SDI OUT, SDI IN and 2nd DVI HD).
- A license may enable multiple internal application features.

### 3.5.2 Configuring the License System in the Viz Engine Configuration UI

See [Viz License Configuration](#).

**Note:** By default, the WIBU licensing system with Engine Core license (ENG\_ENG\_CORE) is used when no configuration exists. When no such license is available the configuration file must be edited. See [Configuration Entries in the Viz Engine Configuration File](#).

**Note:** Configuration of the combination feature requires that no instance is running on the machine that already allocated a combination feature, else no information can be retrieved and it cannot be configured (due to the access mode of this licenses).

### 3.5.3 Configuration Entries in the Viz Engine Configuration File

Entries changed in 4.0.0 and later: `Legacy_Licensing` (removed), `License_Location` (removed, was replaced by `License_Containers`)

- **License\_Containers:** WIBU license source. Determines where WIBU should search for license containers and allocate licenses from.
  - Can be set to one of the following values:

- `0,0,0` - Any Local container. Searches exclusively for containers located on the same PC or allocated to the same VM (for example, dongle, file).
- `0,0,1` - Any Network container. License is to be sought in the network (LAN, WAN), CodeMeter License Server activated as network server or CmWAN.
- `X,Y,1` - A dedicated container, where `X` is the container mask (for example, 130) and `Y` is the container serial (for example, 3910158968)
- Default: `0,0,1`
- **License\_Core:** WIBU core license, which determines also the available additional licenses.
  - For WIBU license details, see [WIBU Licenses and their Effect](#).
  - Can be set to one of the following values:
    - `ENG_ENG_CORE` - Engine Core
    - `ENG_PRV_CORE` - Preview Core
    - `ENG_FRAMESEVERER_CORE` - Frameserver Core
    - `ART_ARTIST_FREE` - Free Viz Artist
  - and for OEM (see Note on Shared Licenses)
    - `VIZLIB_LIBERO_CORE` - Viz Libero Core
    - `VIZARE_VIZARENA_CORE` - Viz Arena Camera Tracking Engine
    - `VIZECL_VIZECLIPSE_CORE` - Viz Eclipse Core
- **Additional\_Licenses:** WIBU additional licenses that are additionally consumed and determined by the core license.
  - For WIBU license details, see [WIBU Licenses and their Effect](#).

 **Note:** When a license is configured it is consumed, even when it has no effect. If licenses are configured that are not allowed, an error is logged on startup.

#### WIBU Additional Licenses for Engine Core License ENG\_ENG\_CORE

License	Key	Description
Viz Artist	ENG_ARTIST	Enables Viz Artist User Interface
DVI OUT HD	ENG_CF_DVI	Enables Render Preview in OnAir mode
NDI input/output single	ENG_CF_NDI	Enables NDI in and Out channel for one instance
MezzIP single	ENG_CF_MEZZIP	Enables Mezzanine in/out channel for one instance
Frameserver single	ENG_CF_FS	Enables Multiplexer communication ports for one instance

License	Key	Description
SDI/IP Video Input Enablement (max)	ENG_ING_SDIIP_MAX	Enables all SDI/IP input channels
NDI IN Upgrade (max)	ENG_IN_NDI_MAX	Enables all NDI input channels
MezzIP IN Upgrade (max)	ENG_IN_MEZZIP_MAX	Enables all mezzanine IP inputs
SDI/IP OUT Channel	ENG_OUT_SDIIP	Enables SDI/IP output
NDI OUT Channel	ENG_OUT_NDI	Enables NDI output
MezzIP OUT Upgrade (max)	ENG_OUT_MEZZIP_MAX	Enables mezzanine IP output
4K Video Enablement	ENG_ING_4KVIDEO	Allows rendering in UHD
DVI OUT Max Resolution	ENG_OUT_DVI_MAX	Enables Fullscreen output (Videowall)
Multiple Frameservers (max)	ENG_OUT_FS_MAX	Enables Multiplexer communication ports for all instances
Chroma FX	ENG_PLUG_CHROMAFX	Enables Chroma Keyer
Global Illumination FX	ENG_PLUG_GI	Enables Global Illumination Editing
Vizrt Multi-touch Plug-in Package	ENG_PLUG_MULTITOUCH	Enables Multitouch plug-ins
Bone&Skin Live Motion Capture	ENG_PLUG_MOCAPREAD	Enables Capturing of Tracking Data (in Combination with Tracking Hub)
Cinema 4D Import	ENG_PLROY_CINEMA4D	Allows import of C4D files
Dolby E Decoder License	ENG_PLROY_DOLBYDEC	Allows processing of Dolby E audio
Dolby E Encoder License	ENG_PLROY_DOLBYENC	Allows output of Dolby E audio

License	Key	Description
Viz Engine DNxHD Codec Support	ENG_PLROY_DNXHD	Allows playback/encoding of DNxHD compressed video
RTT Shaders FX	ENG_PLROY_RTTFX	Enables RTT shader package
Substance FX Authoring	ENG_PLROY_SUBSAUTH	Allows editing of Substance Materials
ezGallery	ENG_PLROY_EZGALLERY	Enables Erizos plug-in
ezPostFx	ENG_PLROY_EZPOSTFX	Enables Erizos plug-in
ezShaders	ENG_PLROY_EZSHADERS	Enables Erizos plug-in
ezMesh	ENG_PLROY_EZMESH	Enables Erizos plug-in
ezDeform	ENG_PLROY_EZDEFORM	Enables Erizos plug-in
ezComposer	ENG_PLROY_EZCOMPOSER	Enables Erizos plug-in
ezLogic	ENG_PLROY_EZLOGIC	Enables Erizos plug-in
ezLink	ENG_PLROY_EZLINK	Enables Erizos plug-in
ezTubular	ENG_PLROY_EZTUBULAR	Enables Erizos plug-in
ezJavascript (Pro)	ENG_PLROY_EZJSPRO	Enables Erizos plug-in
DornaMT APP	ENG_PLROY_DORNA_MTAP	Enables Dorna Multitouch Application
DornaMT Plug-in	ENG_PLROY_DORNA_MTPL	Enables Dora Multitouch plug-in

License	Key	Description
DSX Core HD license	ENG_DSXCORE_HD	Enables DSX Core functionality up to HD resolution
DSX Core UHD License	ENG_DSXCORE_UHD	Enables DSX Core functionality up to UHD resolution
Flexbox plug-in	ENG_FLEXBOX	Enables Flexbox plug-in for Adaptive Scenedesign
Enable Parallel Outputs	3_ENG_PARALLEL_OUTPUTS	Enables multiple outputs
ClipPlayer Pro	ENG_CLIP_PLAYER_PRO	Enables playback of licensable Video Codecs like h265 or HAP

#### WIBU Additional Licenses for Core License ENG\_PRV\_CORE

License	Key	Description
Viz Artist	ENG_PRV_ARTIST	Enables Viz Artist User Interface
DSX Core HD license	ENG_DSXCORE_HD	Enables DSX Core functionality up to HD resolution
DSX Core UHD License	ENG_DSXCORE_UHD	Enables DSX Core functionality up to UHD resolution

#### WIBU Additional Licenses for Core License ENG\_FRAMESERVER\_CORE

License	Key	Description
Multiple Frameservers (max)	ENG_OUT_FS_MAX	Enables Multiplexer communication ports for all instances

#### WIBU Additional Licenses for Viz Libero Core License

- Viz Engine DNxHD Codec Support

#### WIBU Additional Licenses for Viz Arena Core License

- Viz Engine DNxHD Codec Support

## WIBU Additional Licenses for Viz Eclipse Core License

- Viz Engine DNxHD Codec Support

## 3.6 WIBU License System

### 3.6.1 Summary of Key Concepts in the Licensing System

- Core- and additional licenses exist.
- OUT based channel counting for NDI/SDI/IP
- IN and OUT channels are resolution independent up to 3G HD
  - <=2K size of render output
- Preview channels (preview/clean feed OUT) are co-enabled with every OUT channel license.
- MezzIP applies to all compressed streams:
  - Included: RTP/UDP/WebRTC
  - Excluded (requires SDI/IP licenses): SMPTE ST2022-06, ST2022-07, ST2110; ASPEN.
- Multiple licenses may enable the same application feature!
- Licenses are consumed by multiple processes and license share mode influences possible consumption (see [WIBU License Share Status](#)).

### 3.6.2 WIBU License Share Status

Refers to a WIBU license and how its usage is counted when it is allocated/consumed.

- **Exclusive:** Allocation can only be performed once on a node (=machine).
- **User Limit:** Each allocation is counted, independent of instance and node.
- **Shared:** Each allocation is counted once per node. Multiple allocations on the same node allocate only a single license.
- **No User Limit:** Only checked for existence, no counting is performed.

License count reduction when consumed on a node in an instance						
License share status	Node 1			Node 2		
	Instance 1	Instance 2	Instance 3	Instance 1	Instance 2	Instance 3
Exclusive	-1	fails	fails	-1	fails	fails
User Limit	-1	-1	-1	-1	-1	-1
Shared	-1	0	0	-1	0	0

















































License count reduction when consumed on a node in an instance						
License share status	Node 1			Node 2		
	Instance 1	Instance 2	Instance 3	Instance 1	Instance 2	Instance 3
No User Limit	0	0	0	0	0	0

### 3.6.3 WIBU Core License Summary

The following table represents which features are included in one of the Core features and what additional feature might need to be configured.

License	Engine Core	Preview Core	Frames ever Core	Free Viz Artist	Viz Arena Viz Libero Viz Eclipse
Artist	✓ ENG_ARTIST	✓ ENG_PRV_ARTIST	✗	✓	✗
Clips / Clip Player	✓	✓	✗	✓	✓
Engine Core plug-ins	✓	✓	✗	✓	✓
SDI/IP Input	✓ ENG_ING_SDIIP_MAX	✓	✗	✗	✓
SDI/IP Output	✓ ENG_OUT_SDIIP	✓ (Watermark)	✗	✗	✓
NDI Input	✓ ENG_CF_NDI or ENG_IN_NDI_MAX	✓	✗	✗	✓
NDI Output	✓ ENG_CF_NDI or ENG_OUT_NDI	✓ (Watermark)	✗	✗	✓



Mezzanine IP in	 <b>ENG_CF_MEZZIP</b> or <b>ENG_IN_MEZZIP_MAX</b>				
Mezzanine IP out	 <b>ENG_CF_MEZZIP</b> or <b>ENG_OUT_MEZZIP_MAX</b>	 (Watermark)			
Frameserver	 <b>ENG_CF_FS</b> or <b>ENG_OUT_FS_MAX</b>				
DVI Out (<=2K)	 <b>ENG_CF_DVI</b> or <b>ENG_OUT_DVI_MAX</b>	 (Watermark on Resolution >=PAL)		 Watermark	
Unlimited DVI Out (Videowall)	 <b>ENG_OUT_DVI_MAX</b>	 (Watermark)		 (Watermark)	
4K Enablement	 <b>ENG_ING_4KVIDEO</b>	 (Watermark on Resolution >=PAL)		 (Watermark)	
Unlimited Frameserver	 <b>ENG_OUT_FS_MAX</b>				
Chroma Keyer	 <b>ENG_PLUG_CHROMAFX</b>				
Global Illumination	 <b>ENG_PLUG_GI</b>				
Multitouch Plug-ins	 <b>ENG_PLUG_MULTITOUCH</b>				

Bone&Skin Live Motion Capture	✓ ENG_PLUG_MOCAPRE AD	✓	✗	✗	✗
Cinema 4D Import	✓ ENG_PLROY_CINEMA4 D	✓ ENG_PLROY _CINEMA4D	✗	✗	✗
RTT Shaders	✓ ENG_PLROY_RTTFX	✓ ENG_PLROY _RTTFX	✗	✗	✗
Substance Shader	✓ ENG_PLROY_SUBSAUT H	✓ ENG_PLROY _SUBSAUTH	✗	✗	✗
Dolby E Encoding	✓ ENG_PLROY_DOLBYEN C	✓ ENG_PLROY _DOLBYENC	✗	✗	✗
Dolby E Decoding	✓ ENG_PLROY_DOLBYDE C	✓ ENG_PLROY _DOLBYDEC	✗	✗	✗
DNxHD Codec	✓ ENG_PLROY_DNXHD	✓ ENG_PLROY _DNXHD	✗	✗	✓ ENG_PLR OY_DNXH D
Erizos Plug-ins	✓ ENG_PLROY_EZxxxx	✓ ENG_PLROY _EZxxxx	✗	✗	✗
Dorna Plug-ins	✓ ENG_PLROY_DORNA_ xxxx	✓ ENG_PLROY _DORNA_xx xx	✗	✗	✗
UE4 Render Blade Core	✓ ENG_UE4_RENDER_ BLADE_CORE	✓ ENG_UE4 _RENDER_BL ADE_CORE	✗	✗	✗
DSX Core HD license	✓ ENG_DSXCORE_HD	✓	✗	✗	✗
DSX Core UHD license	✓ ENG_DSXCORE_UHD	✓	✗	✗	✗

Flexbox plug-in	✓ ENG_FLEXBOX	✓ ENG_FLEXBOX	✗	✗	✗
Enable Parallel Outputs	✓ 3_ENG_PARALLEL_OUTPUTS	✓ 3_ENG_PARALLEL_OUTPUTS	✗	✗	✗
ClipPlayer Pro	✓ ENG_CLIP_PLAYER_PRO	✗	✗	✗	✗

### 3.6.4 WIBU Licenses and Their Effect

A WIBU license is a dedicated license (application ID) in the WIBU license system.

License short name and License long name	WIBU Share Status	Description
Core Licenses		Core licenses are used as prerequisite for other licenses and define the basic feature set.

<p>ENG_ENG_CORE Engine Core</p>	<p>Shared</p>	<p>Basic core license to be able to start Viz Engine. Included functionality:</p> <ul style="list-style-type: none"> <li>• GFX <ul style="list-style-type: none"> <li>• only boundary is the channel resolution/size (2K).</li> </ul> </li> <li>• Clips / Clip Player <ul style="list-style-type: none"> <li>• No limits on Clip Player (incl. broadcast format clip playback - of course proper Matrox Codecs required)</li> </ul> </li> <li>• Plug-ins <ul style="list-style-type: none"> <li>• Image FX</li> <li>• Real FX</li> <li>• Spline FX</li> <li>• Text FX</li> <li>• Pixel FX</li> <li>• Graffiti FX</li> <li>• Weather</li> <li>• SocialTV (<b>NOTE:</b> was never restricted)</li> <li>• Engine 3D Stereo Upgrade (=3D Stereo)</li> <li>• EVS Control Plug-in</li> <li>• Geo FX</li> </ul> </li> <li>• Viz Engine functionality: <ul style="list-style-type: none"> <li>• Audio FX</li> <li>• Video FX</li> <li>• After Effects Import</li> </ul> </li> <li>• Postrender 2K <ul style="list-style-type: none"> <li>• With ENG_ING_4KVIDEO up to 4K</li> <li>• With ENG_OUT_DVI_MAX unlimited</li> <li>• Postrender on screen preview has a watermark, except when postrendering is actually performed</li> </ul> </li> </ul>
-------------------------------------	---------------	------------------------------------------------------------------------------------------------------------------------------------------------------------------------------------------------------------------------------------------------------------------------------------------------------------------------------------------------------------------------------------------------------------------------------------------------------------------------------------------------------------------------------------------------------------------------------------------------------------------------------------------------------------------------------------------------------------------------------------------------------------------------------------------------------------------------------------------------------------------------------------------------------------------------------------------------------------------------------------------------------------------------------------------------------------------------------------------------------------------------------------------------------------------------------------------------------------------------------------------------

<p>ENG_PRV_CORE Preview Core</p>	<p>User Limit</p>	<p>Usage 1: Trio / other client applications requiring local preview Usage 2: Standalone preview machine for DVI, Mezzanine, NDI or SDI output always with watermark</p> <p>Disabled:</p> <ul style="list-style-type: none"> <li>• Frameserver (Network) OUT</li> </ul> <p>Enabled (if licensed):</p> <ul style="list-style-type: none"> <li>• Artist (together with ENG_PRV_ARTIST)</li> <li>• 3DP plug-ins if license is available</li> </ul> <p>Included functionality:</p> <ul style="list-style-type: none"> <li>• All resolutions             <ul style="list-style-type: none"> <li>• ENG_ING_4KVIDEO</li> <li>• ENG_OUT_DVI_MAX</li> </ul> </li> <li>• All plug-ins from ENG_ENG_CORE enabled</li> <li>• All internal plug-ins             <ul style="list-style-type: none"> <li>• ENG_PLUG_CHROMAFX</li> <li>• ENG_PLUG_GI</li> <li>• ENG_PLUG_MULTITOUCH</li> </ul> </li> <li>• All INs enabled             <ul style="list-style-type: none"> <li>• ENG_ING_SDIIP_MAX</li> <li>• ENG_IN_NDI_MAX</li> <li>• ENG_IN_MEZZIP_MAX</li> </ul> </li> <li>• 1xOUT enabled (no extra licenses required)             <ul style="list-style-type: none"> <li>• ENG_OUT_SDIIP</li> <li>• ENG_OUT_NDI</li> <li>• ENG_OUT_MEZZIP_MAX</li> </ul> </li> </ul> <p>Watermark on all OUTs at any time and all resolutions</p> <ul style="list-style-type: none"> <li>• DVI OUT</li> </ul>
--------------------------------------	-------------------	----------------------------------------------------------------------------------------------------------------------------------------------------------------------------------------------------------------------------------------------------------------------------------------------------------------------------------------------------------------------------------------------------------------------------------------------------------------------------------------------------------------------------------------------------------------------------------------------------------------------------------------------------------------------------------------------------------------------------------------------------------------------------------------------------------------------------------------------------------------------------------------------------------------------------------------------------------------------------------------------------------------------------------------------------------------------------------------------------------------------------------------------------------------------------------------------------------------------------------------------------------------------------------------------------------------------------------------------------------------------------------------

		<div style="border: 1px solid orange; padding: 5px; margin-bottom: 10px;"> <p> <b>Note:</b> No watermark on DVI OUT (local preview) and renderer snapshots when the resolution is &lt;= 720x576 pixels (PAL, SD). Output system must be set to PAL/SD.</p> </div> <ul style="list-style-type: none"> <li>• SDI OUT</li> <li>• MezzIP OUT             <ul style="list-style-type: none"> <li>• RTP/UDP OUT</li> <li>• WebRTC OUT (SHM OUT)</li> </ul> </li> <li>• NDI OUT</li> <li>• Postrender</li> <li>• Clip Out Channel</li> <li>• SHM</li> <li>• Flexbox plug-in</li> </ul>
<p>ENG_FRAMESERVER _CORE Engine Frameserver Core</p>	<p>Shared</p>	<p>Basic core license to use Viz Engine as Frameserver (NLE) only. Enabled:</p> <ul style="list-style-type: none"> <li>• Engine Core</li> <li>• Disable Watermark Overlay</li> <li>• Image FX</li> <li>• Real FX</li> <li>• Spline FX</li> <li>• Text FX</li> <li>• Pixel FX</li> <li>• Graffiti FX</li> <li>• Weather FX</li> <li>• Social TV FX</li> <li>• Geo FX</li> <li>• Clip Playback</li> <li>• Post Renderer</li> <li>• Multiplexer Ports</li> </ul>

ART_ARTIST_FREE Free Viz Artist	Exclusive	<p>Free Viz Artist version core license.</p> <p>Equal to an ENG_ENG_CORE with 1 x DVI OUT (limited to 2K) and everything is watermarked, except scene editor (small window in bottom right).</p> <ul style="list-style-type: none"><li>• Enabled:<ul style="list-style-type: none"><li>• Artist</li><li>• GFX</li><li>• Clips / Clip Player</li><li>• Plug-ins of ENG_ENG_CORE</li></ul></li><li>• Restricted:<ul style="list-style-type: none"><li>• Means no SDI/IP, NDI, RTP/UDP IN/OUT, WebRTC OUT</li><li>• Watermark on all OUTs including Postrender, Clip Out</li><li>• Not combinable with any other license</li></ul></li></ul>
------------------------------------	-----------	-------------------------------------------------------------------------------------------------------------------------------------------------------------------------------------------------------------------------------------------------------------------------------------------------------------------------------------------------------------------------------------------------------------------------------------------------------------------------------------------------------------------------------------------------------------------------------------------------------------------------------------------

<p>VIZLIB_LIBERO_CORE Liberio Core</p>	<p>User Counted</p>	<p>OEM Core for Viz Liberio</p> <p>Enabled:</p> <ul style="list-style-type: none"> <li>• Engine Core</li> <li>• Disable Watermark Overlay</li> <li>• SDI Output</li> <li>• NDI Output</li> <li>• 2k-4k Resolution</li> <li>• DVI Output 2k max.</li> <li>• DVI Output All Resolutions</li> <li>• Chroma FX</li> <li>• Audio</li> <li>• DVE</li> <li>• After Effects Import</li> <li>• Image FX</li> <li>• Real FX</li> <li>• Spline FX</li> <li>• Text FX</li> <li>• Pixel FX</li> <li>• Graffiti FX</li> <li>• Weather FX</li> <li>• Social TV FX</li> <li>• EVS Control</li> <li>• Geo FX</li> <li>• unlimited SDI Inputs</li> <li>• unlimited NDI Inputs</li> <li>• Shared Memory Inputs</li> <li>• Shared Memory Outputs</li> <li>• Clip Playback</li> <li>• Post Renderer</li> </ul> <p>Optional:</p> <ul style="list-style-type: none"> <li>• DNxHD Codecs</li> </ul>
--------------------------------------------	---------------------	-----------------------------------------------------------------------------------------------------------------------------------------------------------------------------------------------------------------------------------------------------------------------------------------------------------------------------------------------------------------------------------------------------------------------------------------------------------------------------------------------------------------------------------------------------------------------------------------------------------------------------------------------------------------------------------------------------------------------------------------------------------------------------------------------------------------------------------------------------------------------------



<p>VIZARE_VIZARENA_ CORE Viz Arena Core</p>	<p>User Counted</p>	<p>OEM Core for Viz Arena Enabled:</p> <ul style="list-style-type: none"> <li>• Engine Core</li> <li>• Disable Watermark Overlay</li> <li>• SDI Output</li> <li>• NDI Output</li> <li>• 2k-4k Resolution</li> <li>• DVI Output 2k max.</li> <li>• DVI Output All Resolutions</li> <li>• Chroma FX</li> <li>• Audio</li> <li>• DVE</li> <li>• After Effects Import</li> <li>• Image FX</li> <li>• Real FX</li> <li>• Spline FX</li> <li>• Text FX</li> <li>• Pixel FX</li> <li>• Graffiti FX</li> <li>• Weather FX</li> <li>• Social TV FX</li> <li>• EVS Control</li> <li>• Geo FX</li> <li>• unlimited SDI Inputs</li> <li>• unlimited NDI Inputs</li> <li>• Shared Memory Inputs</li> <li>• Shared Memory Outputs</li> <li>• Clip Playback</li> <li>• Post Renderer</li> </ul> <p>Optional:</p> <ul style="list-style-type: none"> <li>• DNxHD Codecs</li> </ul>
-----------------------------------------------------	-------------------------	------------------------------------------------------------------------------------------------------------------------------------------------------------------------------------------------------------------------------------------------------------------------------------------------------------------------------------------------------------------------------------------------------------------------------------------------------------------------------------------------------------------------------------------------------------------------------------------------------------------------------------------------------------------------------------------------------------------------------------------------------------------------------------------------------------------------------------------------------------------------

<p>VIZLIB_LIBERO_CORE Viz Libero Camera Tracking Core</p>	<p>User Counted</p>	<p>OEM Core for Viz Arena</p> <p>Enabled:</p> <ul style="list-style-type: none"> <li>• Engine Core</li> <li>• Disable Watermark Overlay</li> <li>• SDI Output</li> <li>• NDI Output</li> <li>• 2k-4k Resolution</li> <li>• DVI Output 2k max.</li> <li>• DVI Output All Resolutions</li> <li>• Chroma FX</li> <li>• Audio</li> <li>• DVE</li> <li>• After Effects Import</li> <li>• Image FX</li> <li>• Real FX</li> <li>• Spline FX</li> <li>• Text FX</li> <li>• Pixel FX</li> <li>• Graffiti FX</li> <li>• Weather FX</li> <li>• Social TV FX</li> <li>• EVS Control</li> <li>• Geo FX</li> <li>• unlimited SDI Inputs</li> <li>• unlimited NDI Inputs</li> <li>• Shared Memory Inputs</li> <li>• Shared Memory Outputs</li> <li>• Clip Playback</li> <li>• Post Renderer</li> </ul> <p>Optional:</p> <ul style="list-style-type: none"> <li>• DNxHD Codecs</li> </ul>
<p>ENG_UE4_RENDER_BLADE_CORE UE4 Render Blade Core</p>	<p>Shared</p>	<p>Basic core license to be able to use the UE Render Blade (Unreal integration with the Vizrt Media for Unreal Engine plug-in).</p>
<p><b>Core Addons</b></p>		
<p>NDI input/output single</p>	<p>User Limit</p>	<ul style="list-style-type: none"> <li>• APP_NDI: 1x NDI IN (2K), 1x NDI OUT (2K)</li> </ul>

DVI OUT HD	User Limit	<ul style="list-style-type: none"> <li>APP_DVI: 1x DVI Out (2K) - meant to operate Viz Artist, or feed an HD Monitor.</li> </ul>
MezzIP single	User Limit	<ul style="list-style-type: none"> <li>APP_MEZZ_IP: 1x MezzIP IN (2K), 1x MezzIP OUT (2K) 1x RTP/UDP IN (2K), 1x RTP/UDP OUT (2K)</li> </ul>
Frameserver single	User Limit	<ul style="list-style-type: none"> <li>APP_MUX_PORTS: 1x Frameserver OUT (2K) <ul style="list-style-type: none"> <li>Enable/Disable Vizrt Frame Server and NLE plug-ins with this license. No NLE plug-in should work anymore.</li> </ul> </li> </ul>
ENG_ARTIST Artist	No User Limit	Shipped with and requires ENG_ENG_CORE. Basic license to be able to start the Viz Artist.
ENG_PRV_ARTIST Artist Preview		Shipped with and requires ENG_PRV_CORE. Basic license to be able to start the Viz Artist with Preview Core.
<b>Input Licenses</b>		
ENG_ING_SDIIP_MAX SDI/IP Video Input Enablement (max)	Shared	Requires ENG_ENG_CORE or ING_ING_CORE. SDI/IP Video Input (unlimited channels)
ENG_IN_NDI_MAX NDI IN Upgrade (max)	Shared	Requires ENG_ENG_CORE. Additional NDI streams require unlimited version of respective stream type
ENG_IN_MEZZIP_MAX MezzIP IN Upgrade (max)	Shared	Requires ENG_ENG_CORE. Additional RTP/UDP streams require unlimited version of respective stream type
<b>Output Licenses</b>		
ENG_OUT_SDIIP SDI/IP OUT Channel	User Limit	Requires ENG_ENG_CORE. Referring to: SMPTE ST2022-06, ST2022-07, ST2110; ASPEN Fill+Key is considered to be one channel only (even though requiring two physical outs). Preview channels (preview/clean feed OUT) are co-enabled with every SDI/IP OUT channel license item being purchased.

ENG_OUT_NDI NDI OUT Channel	User Limit	Requires ENG_ENG_CORE. Additional NDI streams.
ENG_OUT_MEZZIP_MAX MezzIP OUT Upgrade (max)	Shared	Requires ENG_ENG_CORE or ENG_SVCHOST_COR. Additional RTP/UDP streams.
3_ENG_PARALLEL_OUTPUTS	User Limit	Requires ENG_ENG_CORE or ENG_PRV_CORE Enables multiple output from same instance. Currently implemented for NDI only.
<b>Other Licenses</b>		
ENG_ING_4KVIDEO 4K Video Enablement	Shared	Requires ENG_ENG_CORE or ENG_SVCHOST_COR. 4K OUT: SDI/IP, NDI, MezzIP (RTP/UDP, WebRTC), postrender. Does not apply to DVI OUT (requires ENG_OUT_DVI_MAX).  <b>Note:</b> Allows OUT of <=4K in both dimensions.
ENG_OUT_DVI_MAX DVI OUT Max Resolution	Shared	Requires ENG_ENG_CORE. Required to unlock 2K DVI OUT limit (for example, for Video walls) and postrender resolution.  <b>Note:</b> No DVI OUT size restriction anymore.
ENG_OUT_FS_MAX Multiple Frameservers (max)	Shared	Requires ENG_ENG_CORE, ENG_FRAMESERVER_CORE Multiple Frame Server instances per Node.
ENG_CLIP_PLAYER_PRO	User Limit	Requires ENG_ENG_CORE. Allows playback of additional Clip codecs like h265 or HAP with VML player.
<b>Plug-in Licenses</b>		
ENG_PLUG_CHROMAFX Chroma FX	Shared	Requires ENG_ENG_CORE.

ENG_PLUG_GI Global Illumination FX	Shared	Requires ENG_ENG_CORE.
ENG_PLUG_MULTITOUCH Vizrt Multi-touch Plug-in Package	Shared	Requires ENG_ENG_CORE.
ENG_PLUG_MOCAP READ Bone&Skin Live Motion Capture	User Limit	Requires ENG_ENG_CORE.
Flexbox plug-in	User Counted	Requires ENG_ENG_CORE or ENG_PRV_CORE.
<b>Third Party Plug-in Licenses</b>		
ENG_PLROY_CINEMA A4D Cinema 4D Import	Shared	Requires ENG_ENG_CORE or ENG_PRV_CORE.
ENG_PLROY_DOLBY DEC Dolby E Decoder License	Shared	Requires ENG_ENG_CORE or ENG_PRV_CORE.
ENG_PLROY_DOLBY ENC Dolby E Encoder License	Shared	Requires ENG_ENG_CORE or ENG_PRV_CORE.
ENG_PLROY_DNXHD D Viz Engine DNxHD Codec Support	Shared	Requires ENG_ENG_CORE or ENG_PRV_CORE.
ENG_PLROY_RTTFX RTT Shaders FX	Shared	Requires ENG_ENG_CORE or ENG_PRV_CORE.
ENG_PLROY_SUBSANTH UTH Substance FX Authoring	Shared	Requires ENG_ENG_CORE or ENG_PRV_CORE.

ENG_PLROY_EZGALLERY ezGallery	Shared	Requires ENG_ENG_CORE or ENG_PRV_CORE. Erizos licenses.
ENG_PLROY_EZPOSTFX ezPostFx	Shared	
ENG_PLROY_EZSHADERS ezShaders	Shared	
ENG_PLROY_EZMESH ezMesh	Shared	
ENG_PLROY_EZDEFORM ezDeform	Shared	
ENG_PLROY_EZCOMPOSER ezComposer	Shared	
ENG_PLROY_EZLOGIC ezLogic	Shared	
ENG_PLROY_EZLINK ezLink	Shared	
ENG_PLROY_EZTUBULAR ezTubular	Shared	
ENG_PLROY_EZJAVASCRIPT ezJavascript (Pro)	Shared	
ENG_PLROY_DORNA_MTAP DornaMT APP	Exclusive	Requires ENG_ENG_CORE or ENG_PRV_CORE. Dorna licenses.
ENG_PLROY_DORNA_MTPL DornaMT Plug-in	Exclusive	

DSX Core HD license DSX Core UHD license	Shared	Requires ENG_ENG_CORE
---------------------------------------------	--------	-----------------------

### 3.7 Notes

#### 3.7.1 Colors used in License Overview

The following color schema is used in Viz Engine to display the status of the license:

**Correct License (white)**

License	Expiration
<input checked="" type="checkbox"/> v2 Engine Core	2023-01-31T13:00:00+0100
<input type="checkbox"/> v2 Artist	2023-01-31T13:00:00+0100
<input type="checkbox"/> v2 DVI out HD	2023-01-31T13:00:00+0100
<input type="checkbox"/> v2 NDI input/output single	2023-01-31T13:00:00+0100
<input type="checkbox"/> v2 MezzIP single	2023-01-31T13:00:00+0100
<input type="checkbox"/> v2 Frameserver single	2023-01-31T13:00:00+0100
<input type="checkbox"/> v2 SDI/IP Video Input Enablement (max)	2023-01-31T13:00:00+0100
<input type="checkbox"/> v2 NDI IN Upgrade (max)	2023-01-31T13:00:00+0100
<input type="checkbox"/> v2 MezzIP IN Upgrade (max)	2023-01-31T13:00:00+0100
<input type="checkbox"/> v2 SDI/IP OUT Channel	2023-01-31T13:00:00+0100
<input type="checkbox"/> v2 NDI OUT Channel	2023-01-31T13:00:00+0100

**Expired License (red)**

License	Expiration
<input checked="" type="checkbox"/> v2 Engine Core	2022-05-15T14:00:00+0200
<input type="checkbox"/> v2 Artist	2022-05-15T14:00:00+0200
<input type="checkbox"/> v2 DVI out HD	2022-05-15T14:00:00+0200
<input type="checkbox"/> v2 NDI input/output single	2022-05-15T14:00:00+0200
<input type="checkbox"/> v2 MezzIP single	2022-05-15T14:00:00+0200
<input type="checkbox"/> v2 Frameserver single	2022-05-15T14:00:00+0200
<input type="checkbox"/> v2 SDI/IP Video Input Enablement (max)	2022-05-15T14:00:00+0200
<input type="checkbox"/> v2 NDI IN Upgrade (max)	2022-05-15T14:00:00+0200
<input type="checkbox"/> v2 MezzIP IN Upgrade (max)	2022-05-15T14:00:00+0200
<input type="checkbox"/> v2 SDI/IP OUT Channel	2022-05-15T14:00:00+0200

**Mixed "Permanent" Licenses**

License	Expiration
<input checked="" type="checkbox"/> v2 Engine Core	invalid expiration date
<input type="checkbox"/> v2 Artist	invalid expiration date
<input type="checkbox"/> v2 DVI out HD	2099-09-30T14:00:00+0200
<input type="checkbox"/> v2 NDI input/output single	invalid expiration date
<input type="checkbox"/> v2 MezzIP single	invalid expiration date
<input type="checkbox"/> v2 Frameserver single	invalid expiration date
<input type="checkbox"/> v2 SDI/IP Video Input Enablement (max)	2099-09-30T14:00:00+0200
<input type="checkbox"/> v2 NDI IN Upgrade (max)	invalid expiration date
<input type="checkbox"/> v2 MezzIP IN Upgrade (max)	invalid expiration date
<input type="checkbox"/> v2 SDI/IP OUT Channel	invalid expiration date

**Note:** A permanent license needs to have a end date set. If no end date is found, the license is invalid and should be renewed.

These licenses are marked as orange.

### Core not available

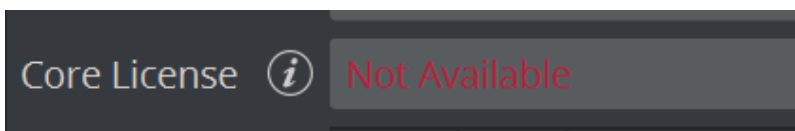

A previously configured Core license which is not available anymore (for example, by switching dongles) is labeled *Not Available* and shown in red.

## 3.7.2 Starting Viz Engine with WIBU License System

- User configured in Viz Engine configuration which license(s) should be used/consumed.
- A core license is required to start Viz Engine.
- To enable higher resolutions for postrendering (>2K) then use:
  - ENG\_ING\_4KVIDEO for up to <=4K width/height.
  - ENG\_OUT\_DVI\_MAX for unlimited resolution.

## 3.7.3 Starting Viz Engine with DVI OUT

- User configured DVI OUT in Viz Engine configuration file: No Videoout, onair\_vga\_preview=1 or VGA version, startup in Engine or Artist mode.
- The following licenses need to be available in WIBU license system:
  - ENG\_CF\_DVI (resolution limited to <=2K width/height).
  - OR ENG\_OUT\_DVI\_MAX (no resolution restriction).
- When configuration is changed at runtime and violates the license restriction, the resolution is limited to the allowed resolution (for example, 2K width/height).
- DVI OUT is required for local preview in external applications (for example, Viz Trio, Pilot Template Wizard, Pilot Director).



- When resolution is higher than 2K the startup fails for ENG\_ENG\_CORE without a proper ENG\_ING\_4KVIDEO or ENG\_OUT\_DVI\_MAX license.

### 3.7.4 Starting Viz Engine with MezzIP OUT and/or 1xMezzIP IN

- Without the ENG\_ING\_4KVIDEO license the output is limited to <=2K width/height.
- When running Viz Engine with RTP/UDP IN/OUT or Service Host with WebRTC OUT the following licenses need to be available in the WIBU license system:
  - OUT: ENG\_CF\_MEZZIP OR ENG\_OUT\_MEZZIP\_MAX
  - IN: ENG\_IN\_MEZZIP\_MAX
- To enable resolutions >2K and <= 4K then ENG\_ING\_4KVIDEO is required.
- See Note on Shared Licenses.

MezzIP Possible OUTs	Engine Effect	Engine Licenses Consumed
1 RTP/UDP IN (2K), 1 RTP/UDP OUT (2K)	Instance 1: 1x RTP/UDP IN (2K), 1x RTP/UDP OUT (2K)	1 ENG_ENG_CORE, ENG_CF
1+ RTP/UDP IN (2K),	1+ RTP/UDP IN (2K) (one or multiple instances)	1(+) ENG_ENG_CORE, ENG_IN_MEZZIP_MAX
1 RTP/UDP IN (2K), 1+ RTP/UDP OUT (2K)	1 RTP/UDP IN (2K)	ENG_ENG_CORE, ENG_CF, ENG_OUT_MEZZIP_MAX
1+ RTP/UDP IN (2K), 1+ RTP/UDP OUT (2K)	1+ RTP/UDP IN (2K) 1+ RTP/UDP OUT (2K)	ENG_ENG_CORE, ENG_IN_MEZZIP_MAX, ENG_OUT_MEZZIP_MAX
4K OUT	4K resolution on any OUT	ENG_ING_4KVIDEO

### 3.7.5 Starting Viz Engine with NDI OUT and/or NDI IN

- When running Viz Engine with NDI IN and/or NDI OUT the following licenses need to be available in the WIBU license system:
  - OUT: ENG\_CF\_NDI OR ENG\_OUT\_NDI
  - IN: ENG\_IN\_NDI\_MAX
- To enable resolutions >2K and <= 4K then ENG\_ING\_4KVIDEO is required.

### 3.7.6 Starting Viz Engine with Frameserver Functionality (MUX Ports)

- When running Viz Engine as a frameserver (for example, for NLE clients or Viz Story) the following licenses need to be available in the WIBU license system:
  - ENG\_CF\_FS to start one frameserver instance per node

- OR ENG\_OUT\_FS\_MAX to start multiple frameserver instances per node
- To enable higher resolutions frameserver snapshots (>2K) then use:
  - ENG\_ING\_4KVIDEO for frameserver snapshots of up to <=4K width/height.
  - ENG\_OUT\_DVI\_MAX for unlimited resolution frameserver snapshots.

### 3.7.7 Starting Viz Engine with SDI/IP OUT or SDI/IP IN

- When running Viz Engine with SDI/IP IN and/or SDI/IP OUT the following licenses need to be available in the WIBU license system:
  - OUT: ENG\_OUT\_SDIIP per output one license is consumed
  - IN: ENG\_ING\_SDIIP\_MAX
- To enable higher resolutions SDI/IP OUT/IN (>2K) use:
  - ENG\_ING\_4KVIDEO for up to <=4K width/height.

### 3.7.8 Starting Viz Engine with Viz Artist

- When running Viz Engine with Viz Artist the following licenses need to be available in the WIBU license system:
  - ENG\_ENG\_CORE and ENG\_ARTIST
  - OR ENG\_PRV\_CORE and ENG\_PRV\_ARTIST
  - OR ART\_ARTIST\_FREE

### 3.7.9 Starting Viz Engine with Unreal Integration (Vizrt Media for Unreal Engine)

- When running Viz Engine with Unreal Integration (Vizrt Media for Unreal Engine) the following licenses need to be available in the WIBU license system:
  - ENG\_ENG\_CORE, ENG\_ING\_SDIIP\_MAX, ENG\_OUT\_SDIIP, ENG\_PLUG\_CHROMAFX and ENG\_UE4\_RENDER\_BLADE\_CORE
  - OR ENG\_PRV\_CORE and ENG\_UE4\_RENDER\_BLADE\_CORE
- Configuration details can be found in **Integration with Unreal Engine** under **Third Party Applications and Files** in the [Viz Artist User Guide](#).

### 3.7.10 Using DSX Core Licenses

DSX Core licenses can only be used on machines without Matrox hardware. Enabling DSX core on Matrox Topology driver based installations can lead into unintended behavior.

### 3.7.11 Permanent Licenses

Permanent Licenses need to have a end date set (typically 99 years). Any permanent license without an end-date is listed as "invalid date" and should be renewed by Vizrt. If this is the case, please contact Vizrt Support.

---

## 3.8 Setup Graphic Hub Journal-Based E-Mail Notifications

- Configure e-mail sending in [Graphic Hub Terminal Options E-Mail settings](#).
  - Configure e-mail addresses and notification options for specific alerts in [Graphic Hub Manager Alert settings](#).
  - Viz Engine directly logs to the Journal of the connected Graphic Hub and triggers e-mail messages for the following alert levels:
    - Level 820: Viz Engine WARNING: License, Warnings reported by Viz Engine related to licensing.
    - Level 920: Viz Engine ERROR: License, Errors reported by Viz Engine related to licensing.
- 

## 3.9 Setup Redundancy For A WIBU License Server

Setting up WIBU license server redundancy is described below. See **License Server Redundancy** in the [Vizrt Licensing Administrator Guide](#) for additional details.

 **Note:** The grace period for acquired licenses is 72 hours if the license is lost to recover possible network issues or the license server.

### 3.9.1 Set Up Redundancy for a WIBU License Server

1. Make sure two hosts (A & B) have *VizrtLicensingInstaller.exe* installed and select **use as network license server** during installation. See **License Server Activation** in the [Vizrt Licensing Administrator Guide](#).
2. Connect one WIBU dongle to 'A' and import a key with licenses.
3. From WIBU web admin UI of 'A', make sure the container exist and all the added features are listed.
4. On the client configure 'A' as first license server, and 'B' as second one (in the search list of the local CodeMeter web admin).

### 3.9.2 Test License Server Failover

1. Set the license configuration in Viz Engine.
2. Start Viz Engine.
3. From CodeMeter web admin UI of 'A', verify that the licenses are allocated and used by the client.
4. Disconnect the network cable of 'A' or shut down the machine.
5. Wait until the Viz Engine(s) starts writing 'License Server not found..' and the grace status for the configured features is 'grace\_state=2/VL\_GRACE\_GRACE, '.
6. Move the WIBU dongle from 'A' to 'B'.
7. Viz Engine recovers and re-obtains the license from 'B'.

### 3.9.3 Recover First License Server

1. Recover license server 'A'.
2. Disconnected the failover license server from network or shut it down.
3. Waited until the Viz Engine(s) enter grace period.
4. Moved WIBU dongle back to the original license server 'A'.
5. Viz Engine recovers and re-obtains the license from 'A'.

### 3.9.4 Notes

- The license must be in the same container to recover. A second license server with a different container does not work.
- Not started Viz Engines which are configured the same, can start and obtain the license from 'B'.
- An arbitrary number of servers can be added to the server search list of CodeMeter, even when Viz Engine is running. It is possible to add a failover server after the original license server failed.

#### See Also

- [Vizrt Licensing Administrator Guide](#)
- [Graphic Hub Administrator Guide](#)
- **Third Party Applications and Files > Integration with Unreal Engine** in the [Viz Artist User Guide](#).

---

## 4 Security Advisor

---

### 4.1 Recommendations

Viz Engine offers an open API to allow any control application to integrate with.

After installation of the software, please proceed with the following advisories:

- Change the default User password. See [Prerequisites](#).
- Do not run Viz Engine with Administrator rights.
- Disable Remote Access for WIBU Codemeter Webadmin and use SSL (**Configuration > Basic > Webadmin**).
- Remove any unneeded services.
  - If FSmon and ArdFTP are not needed, do not install them.
  - Enable Viz Engine REST interface only if needed.
- The recommended NVIDIA driver should be used; however, new vulnerabilities can have been made public after the release of this software and it might be necessary to upgrade the NVIDIA driver (see <https://www.nvidia.com/en-us/security/> for details).
- Do not expose any shares on the network.

#### See Also

- [Ports and Connections](#)

---

## 5 Software Configuration

This section details the prerequisites and supported options for the Viz Artist/Viz Engine installation, and procedures on how and where to install Viz Artist/Engine.

This section contains information on the following topics:

- [Prerequisites](#)
- [Viz Artist and Viz Engine Installation](#)
- [Viz Engine Folders](#)
- [Ports and Connections](#)
- [Viz Log Files](#)
- [Logfiles Configuration](#)
- [Supported Software](#)
- [Import and Export Formats](#)
- [Viz Engine REST Interface](#)
- [User Account Control](#)
- [NDI](#)
- [Dual Channel Mode](#)
- [Trio Box CG Mode](#)
- [Dolby E Support](#)
- [EVS Video Server Control](#)
- [Integration with Viz One](#)
- [Matrox Stream](#)
- [VML Clip Player](#)

## 5.1 Prerequisites

- [Supported Operating Systems](#)
- [Virtual Environments](#)
- [Environment Settings](#)
- [Hardware and BIOS Settings](#)
- [Power Management Settings](#)
- [User Rights](#)
- [Secure Boot](#)
- [Setting Permissions to Run Viz Engine and Viz Artist](#)
- [Anti-Virus Software](#)
- [Additional Prerequisites](#)

### 5.1.1 Supported Operating Systems

Viz Artist and Engine has been tested to run on the following platforms:

Viz Artist/Engine version	Operating System
5.3.1	<ul style="list-style-type: none"> <li>• Windows Server 2022 <sup>(1)</sup></li> <li>• Windows Server 2019 <sup>(1)</sup></li> <li>• Windows 10 LTSC 1809 Edition <sup>(3)</sup></li> <li>• Windows 10 LTSC 2021 Edition (21H2)</li> <li>• Windows 11 LTSC (24H2)</li> </ul>
5.3	<ul style="list-style-type: none"> <li>• Windows Server 2022 <sup>(1)</sup></li> <li>• Windows Server 2019 <sup>(1)</sup></li> <li>• Windows 10 LTSC 1809 Edition <sup>(3)</sup></li> <li>• Windows 10 LTSC 2021 Edition (21H2)</li> <li>• Windows 11 <sup>(2)</sup></li> </ul>
5.2	<ul style="list-style-type: none"> <li>• Windows Server 2022 <sup>(1)</sup></li> <li>• Windows Server 2019 <sup>(1)</sup></li> <li>• Windows 10 LTSC 1809 Edition <sup>(3)</sup></li> <li>• Windows 10 LTSC 2021 Edition (21H2)</li> <li>• Windows 11 <sup>(2)</sup></li> </ul>
5.1	<ul style="list-style-type: none"> <li>• Windows Server 2022 <sup>(1)</sup></li> <li>• Windows Server 2019 <sup>(1)</sup></li> <li>• Windows 10 LTSC 1809 Edition <sup>(3)</sup></li> <li>• Windows 10 LTSC 2021 Edition (21H2)</li> <li>• Windows 11 <sup>(2)</sup></li> </ul>

Viz Artist/Engine version	Operating System
5.0	<ul style="list-style-type: none"> <li>• Windows Server 2022 <sup>(1)</sup></li> <li>• Windows Server 2019 <sup>(1)</sup></li> <li>• Windows Server 2016 <sup>(1)</sup></li> <li>• Windows 10 LTSC 1809 Edition <sup>(3)</sup></li> <li>• Windows 10 LTSC 2021 Edition (21H2)</li> <li>• Windows 11 <sup>(2)</sup></li> </ul>
4.4.x	<ul style="list-style-type: none"> <li>• Windows Server 2019</li> <li>• Windows Server 2016</li> <li>• Windows 10 LTSC 1809 Edition</li> <li>• Windows 10 LTSC 2021 Edition (21H2)</li> </ul>
4.3	<ul style="list-style-type: none"> <li>• Windows Server 2019</li> <li>• Windows Server 2016</li> <li>• Windows 10 LTSC 1809 Edition</li> </ul>
4.0, 4.1, 4.2	<ul style="list-style-type: none"> <li>• Windows Server 2016</li> <li>• Windows 10 LTSC 1809 Edition</li> </ul>
3.14	<ul style="list-style-type: none"> <li>• Windows Server 2008 R2/SP1 (64-bit)</li> <li>• Windows Server 2016</li> <li>• Windows Server 2012 R2</li> <li>• Windows 7 (64-bit)</li> <li>• Windows 10 (64-bit) 1809</li> <li>• Windows 10 IoT/LTSC Edition</li> </ul>
<p><sup>1)</sup> Server OS are used for VM and cloud environments only.</p> <p><sup>2)</sup> Windows 11 LTSC versions have not been fully tested and certified yet.</p> <p><sup>3)</sup> Unreal Engine requires a newer Windows 10 version than 1809. UE Integration was successfully tested with 21H2</p>	

For optimal performance, use the pre-installed Windows image from Vizrt. You can obtain the Windows image files from your [local support office](#).

 **Note:** Only English Operating System(s) are supported.

### 5.1.2 Virtual Environments

The following virtual environments have been tested and certified to host Viz Engines:



	Viz Engine Render Pipeline	Viz Classic Render Pipeline
Amazon AWS cloud	✓	✓
Microsoft Azure	✓	✓
VMWare ESxi (6.0, 6.5,7.02, vSphere 8.0.2)	✓	✓
nutanix/fra.me	not tested	✓
AliBaba Cloud	not tested	✓

 **Note:** Backup and Restore on Azure systems is currently not supported.

### 5.1.3 Environment Settings

The following prerequisites apply on all platforms. Applying the changes may require local administrator access rights, new or changing group policy entries, or modifying services. Contact your local IT manager for further instructions.

Perform all Windows Updates, except hardware driver updates. This is especially important for drivers related to NVIDIA and Matrox hardware, and Codemeter dongle drivers. In addition to this;

- Turn off windows sounds.
- Turn off AutoPlay.
- Turn off Windows Media Player Network Sharing Service.
- Disable Windows Defender.

Set **Visual Effects** to **Adjust for best performance**. This is set in the Performance Options window; right click the Start button and select **System**, then select **Advanced system settings** and click the **Settings** button in the **Performance** section.

### 5.1.4 Hardware and BIOS Settings

The following considerations must be made regarding hardware:

- There must only be one active network card.
- Hardware must be installed, and BIOS configured, as suggested for the machine model.

### 5.1.5 Power Management Settings

Power management and hibernation mode must set to **Off**. Execute `powercfg -h off` from the command line to remove `hiberfil.sys` from the hard disk.

In addition to this, set the following under Power Options:

- Never turn off display.
- Never turn off hard disks.
- Disable USB selective suspend setting.
- Set Power button action to **Do nothing**. This prevents accidental shutdown in case someone presses the power button by mistake.

### 5.1.6 User Rights

The user must have special rights to run Viz Artist and Viz Engine. This can be achieved by assigning local administrator rights to the user, or by explicitly granting the required privileges. See Running Viz Engine and Viz Artist without administrator rights below for further details.

Any hardware solution provided by Vizrt is certified for use with Viz Engine. These come with a predefined default User that has administrator rights on the machine. The default administrator account is as follows:

User name	Password	Account Type
Admin	vizrt	Computer Administrator

 **IMPORTANT!** Make sure that you change this password after initial installation!

 **IMPORTANT!** Running the Engine as Administrator results in limitations in Viz Artist. For example, it is not possible to import files using drag & drop into Viz Artist.

### 5.1.7 Secure Boot

Matrox drivers require a special version (labeled `_EV.exe`) for installing on secure boot enabled systems. If your driver fails to install, please disable secure boot in the BIOS settings.

To learn more about the different user account types, refer to the Windows operating system documentation, or visit [www.microsoft.com](http://www.microsoft.com).

### 5.1.8 Setting Permissions to Run Viz Engine and Viz Artist

Since version 5.x, there is no need for administrator privileges to run Viz Engine. However, some operations still require special permission that usually are not given to a standard user:

Privilege	Description	Necessary if	Comment
SeIncreaseBasePriorityPrivilege	Increases scheduling priority	Matrox installed or engine-mode ( <code>-n</code> ) DataReader plug-in (for example, to access Excel files in use )	Loading content from external applications like using DataReader with Microsoft Excel without closing the source Excel file would need this token configured.

Privilege	Description	Necessary if	Comment
SeCreateGlobalPrivilege	Creates global objects	VDCP enabled or scroller plug-in	Scroller plug-in usage is not detected on startup.
SeCreatePagefilePrivilege	Creates a pagefile	Scroller plug-in	Scroller plug-in usage is not detected on startup.
SeIncreaseWorkingSetPrivilege	Increases a process working set	Matrox installed	

These settings need to be changed in the local security policy:

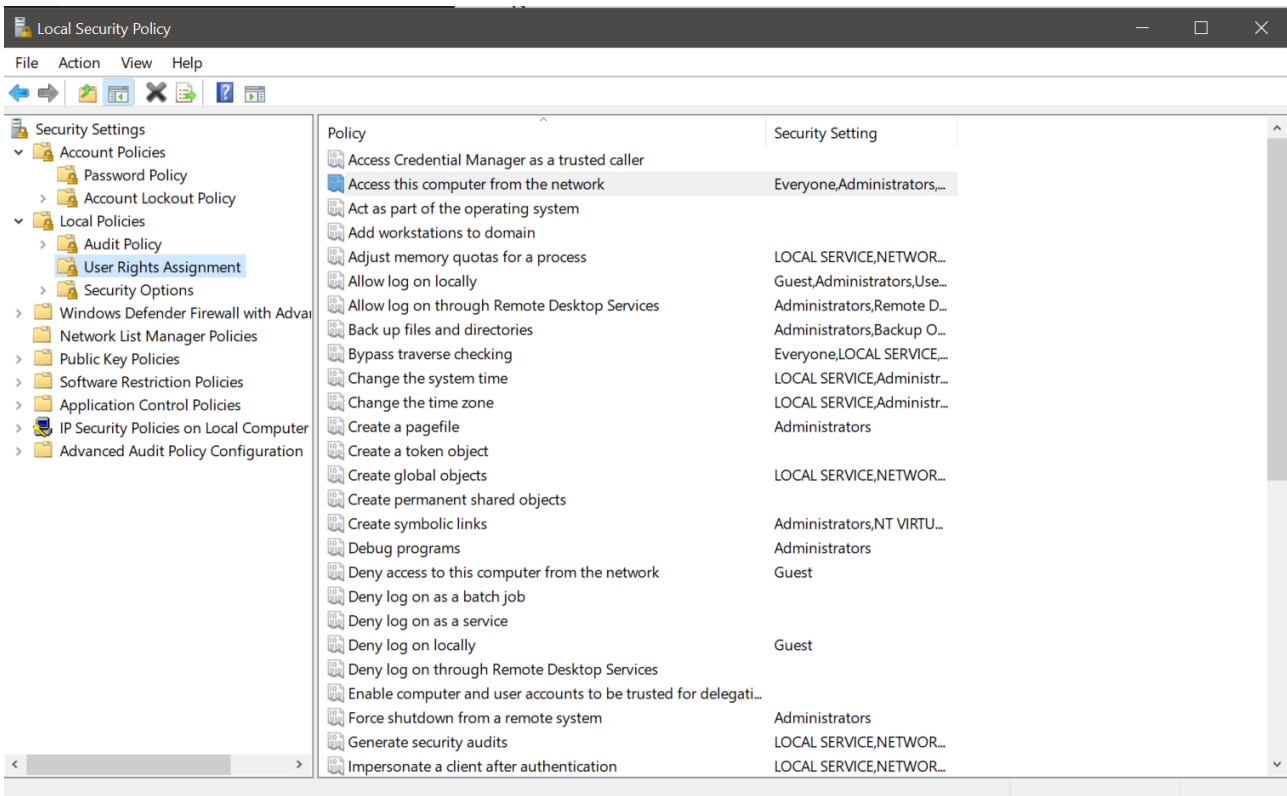

**✘ IMPORTANT!** You need to restart Windows after setting these permissions.

**✘ IMPORTANT!** Please contact your local IT manager for further information on how this is handled within the organization.

## 5.1.9 Anti-Virus Software

Anti-Virus software, including end-point protection, can cause various problems such as time-out and performance issues on the Graphic Hub database and other Vizrt machines, as every file is checked. To avoid these problems, make sure to exclude the *VizGH.exe* process and the underlying Graphic Hub data directory (default *D:\VizGHData* or *E:\VizGHData*) in the scan/real-time settings of the Anti-Virus software. Regarding Graphic Hub, more anti-virus-related information can be found in the [Graphic Hub Administrator Guide](#).

These are the general Viz Engine recommendations for anti-virus scan exceptions:

- Services
  - Fsmon
  - Mediaftp
  - VizrtLicensing
  - CodeMeter.exe
- Processes
  - Fsmon
  - Mediaftp
  - Viz.exe
- Folders
  - **Installation directory:** *C:\Program Files\Vizrt\VizEngine*
  - **Program data:** *C:\ProgramData\vizrt\VizEngine*
  - Configured clip data directory

Also, full system scans should not be done while Viz Engine is On Air.

If any Anti-Virus software is used without the above settings, optimal performance cannot be guaranteed, nor the long-term stability of Vizrt products.

There are hundreds of Anti-Virus software packages on the market. We do not recommend the use of any specific Anti-Virus software package or version, or give any recommendations on how to setup any Anti-Virus software suites in relation to Vizrt software and machines.

## 5.1.10 Additional Prerequisites

- DirectX 9 runtime is required if Global Illumination is used.

### See Also

- [Viz Engine Folders](#)
- [Supported Software](#)

## 5.2 Viz Artist And Viz Engine Installation

Use the Viz Artist Bundle Installer to install both Viz Artist and Viz Engine. The bundle installer contains Viz Artist, Viz Engine, the license dongle drivers (Codemeter and legacy Hardlock), and all required dependencies.

This section covers the following topics:

- [Installing Viz Artist and Engine](#)
- [Upgrading from a Previous Installation](#)
- [To Change or Reinstall an Existing Installation](#)
- [Silent Installation of Viz Artist and Engine](#)
- [Installation of a Specific Component](#)
- [Unattended Installation of Viz Artist and Engine](#)
  - [Additional Parameters](#)
  - [Installed Components](#)
  - [Example](#)
- [To Identify Installed Version](#)

The software package is available in 64-bit, where the architecture is **x64**. By common convention, x64 signifies the 64-bit version.

The file name of the bundle installer indicates the architecture and software version in the following pattern: *Name-Architecture-Major.Minor.Maintenance.Build*.

**Example:** The file *VizArtistBundle-x64-4.3.0.99999.exe* is the bundle installer for Viz Artist and Viz Engine version 4.3.0, for 64-bit architecture platforms.

### 5.2.1 Installing Viz Artist and Engine

Installation of Viz Artist and Engine requires elevated permissions on the destination computer. Make sure to log on to the computer with either an administrator account or a user account with elevated rights, before installing the software. See [Running Viz Engine and Viz Artist without administrator rights](#) for further details. If you install Viz Artist on a non-supported operating system platform, you get a warning message.

Before installing the software, make sure to:

- Check that your computer meets the [Prerequisites](#) for hardware and system configuration.
- Decide which of the Viz Artist/Viz Engine Platforms is suitable for your installation.
- If upgrading, familiarize yourself with the information in the [Upgrading from a previous installation section](#).

**Tip:** Download the Viz Artist and Engine installer from Vizrt's FTP server.

**Info:** Both **Mediaftp** and **Fsmom** have individual *.msi* installers rather than being included in the Viz Engine *.msi* starting with Viz Engine version 4.0. They are included in the Viz Artist Bundle installer.

1. Run the installer. The bundle installer provides an overview of all required dependencies that need to be installed in addition to the main application. Already installed dependencies are listed as **Installed**. You can collapse the selection list by clicking **Settings**.

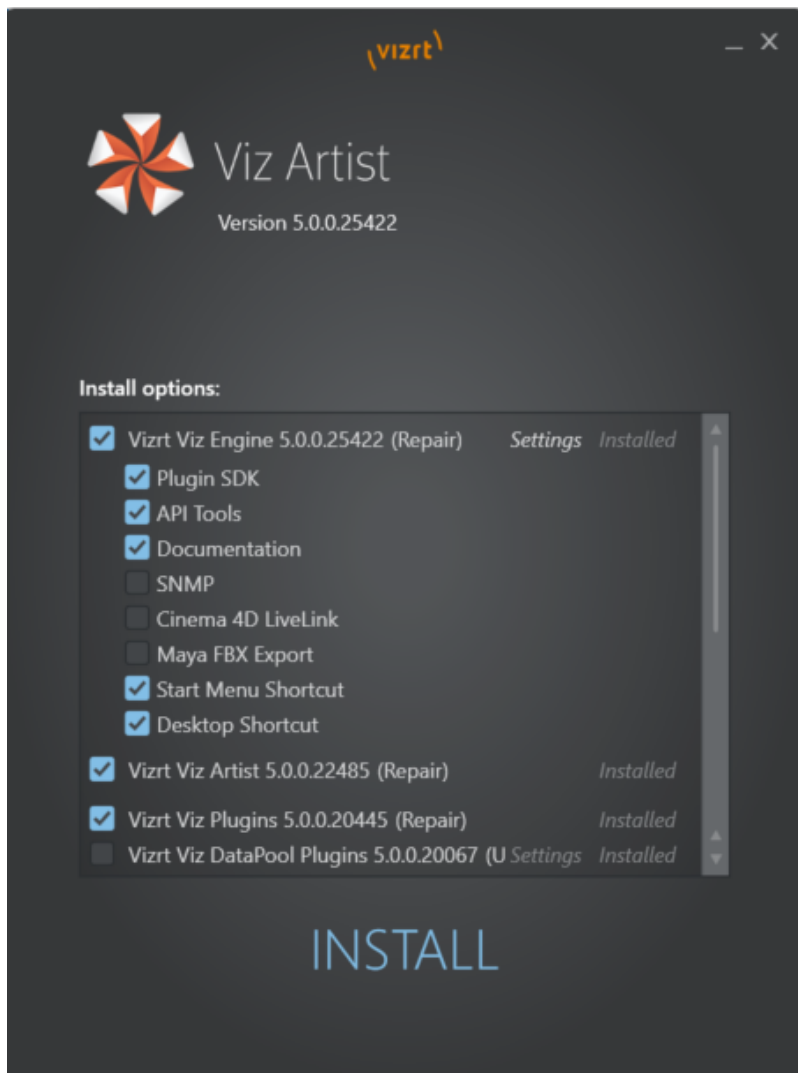

**Note:** The bundle installer selects most features by default. Check the feature list and add or remove features as required.

2. Scroll further down to select a custom installation location, if required.

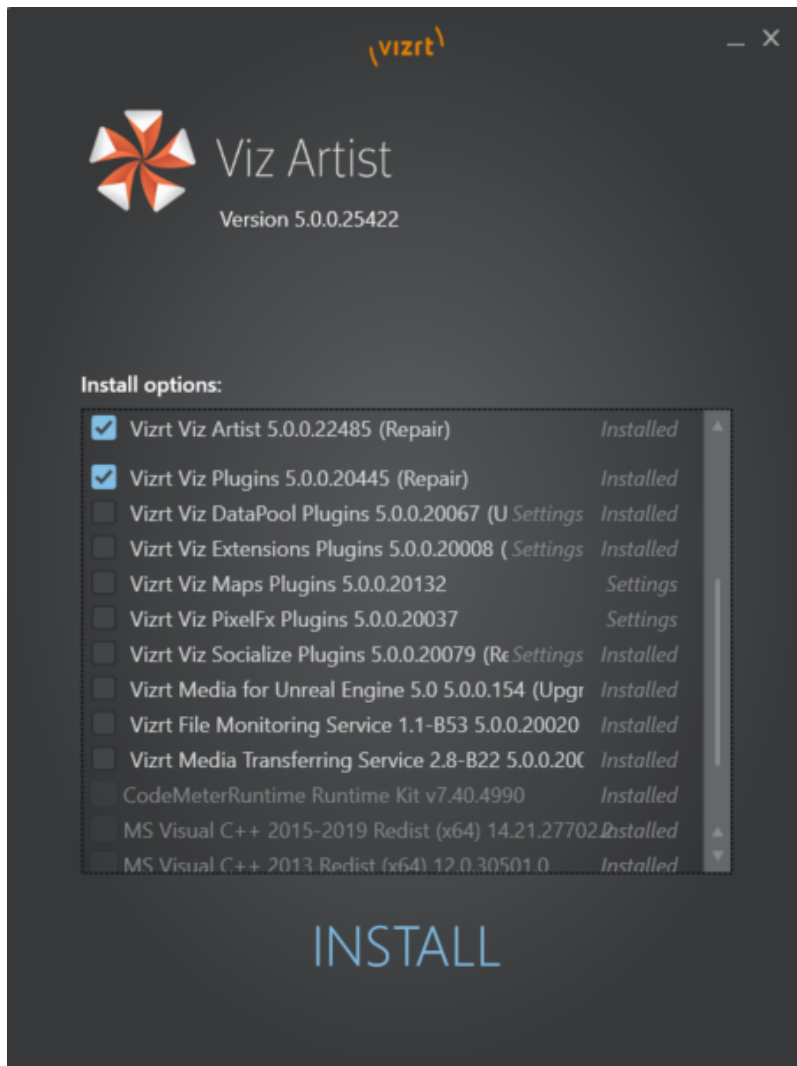

3. Click **INSTALL** to complete the installation wizard. The various dependencies are installed as required.
4. Click **Finish**.

If something interrupts the installation, click **Show log** to view the installation log files.

## 5.2.2 Upgrading from a Previous Installation

When you upgrade an existing installation to a new version of Viz Artist and Engine, observe the following:

- Create a backup file of your existing configuration files (.cfg), especially if you are upgrading from a 3.x version. The default data directory for Viz Engine 3 is %ProgramData%\vizrt\Viz3\. The default Viz Engine data directory is %ProgramData%\vizrt\VizEngine\.
- If Viz Engine 3 was installed, follow-up versions since Viz Engine 4 print the error message *An incompatible version of Viz Engine is installed*. In this case, Viz Engine 3 must be uninstalled, as it is not possible to have both versions installed on a system.
- If upgrading an existing installation with the Viz Artist.msi installation file, you see this message: “Viz Artist 32-bit is already installed. Remove the existing installation first, then restart the installer.” Open **Uninstall a**

**program** from the Control Panel, select Viz Artist and remove the existing installation. Then run the *.msi* file to install Viz Artist/Engine.

- Installing Viz Artist/Viz Engine using the bundle installer upgrades older installations. Any older version is removed, except versions prior to Viz Artist and Engine 3.6. This is true even if you opt to install Viz Artist/Viz Engine in a different directory.
- The installer suggests installing to the previous installation folder. You may change it. The recommended installation directory is `C:\Program Files\vizrt\VizEngine`.
- The installer pre-selects all previously installed features. You may change them.
- The installer does not support downgrading. Remove the currently installed version to install an earlier version of Viz Artist and Viz Engine.
- Upgrading does not change any modified or newly added files of the old installation. For example, Configuration files, Log files or additional files like customer plug-ins remain unchanged in their original folder.
- Since Viz version 3.7.1, *viz.exe* no longer checks the `%Program Files%` folder for Configuration files (*.cfg*) or Lens files (*.lcb*). These files must be located in `%ProgramData%\vizrt\vizEngine`.
  - If the previous Viz Artist/Viz Engine was installed in the default folder, the Configuration and Lens files are automatically copied during upgrade from the default installation folder to `%ProgramData%\vizrt\vizEngine`.
  - If the previous Viz Artist/Viz Engine was installed in a custom folder, the Configuration and Lens files need to be copied manually from the old installation folder to `%ProgramData%\vizrt\vizEngine`.

### 5.2.3 To Change or Reinstall an Existing Installation

Use the Viz Artist bundle installer to change or reinstall an existing installation. The installer pre-selects any already installed features. Check the boxes for the components that you want to add or remove, then click **INSTALL**. This reinstalls the complete software suite, repairing any damaged or accidentally deleted files.

### 5.2.4 Silent Installation of Viz Artist and Engine

To install Viz Engine bundle with all its default settings call `VizArtistBundle-x64-5.x.x.x.exe -s` as administrator.

### 5.2.5 Installation of a Specific Component

 **Warning:** When using *msiexec*, always use command line. Powershell does not work in all cases.

To install a specific *.msi* from the bundle, perform following steps:

1. Open a command line and call `VizArtistBundle-x64-5.x.x.x.exe --dump`. This extracts all bundles *.msi* installers into a subfolder called "**VizArtistBundle - 5.x.x.x**".
2. Enter `msiexec` on the command line and press enter to see other options. Common options are:
  - **/i**: Installs or configures a product. Package: Specifies the name of the Windows Installer package file. ProductCode: Specifies the globally unique identifier (GUID) of the Windows Installer package.
  - **/x**: Removes a product. Package: Name of the Windows Installer package file. ProductCode: Globally unique identifier (GUID) of the Windows Installer package.



- **/l, /log:** Enables logging. Make sure to specify the log file name.

**Example:** `msiexec /i VizArtist.4.3.0.5.msi /norestart /passive  
INSTALLDIR_ARTIST="C:\tmp" -lv installation.log`

**Warning:** Be aware, certain plug-ins for various integrations need to be copied manually to their respective locations (Unreal, Cinema4D, After Effects, ....).

## 5.2.6 Unattended Installation of Viz Artist and Engine

To install Viz Artist in an unattended mode (the window of the Viz Artist bundle installer is displayed but without allowing user interaction except to cancel the installation progress) with default parameters, the following command should be used in a command prompt started as administrator:

```
"[Absolute path to the Viz Artist Bundle installer] --silent"
```

### Additional Parameters

Parameter name	Default Value	All possible values
<b>Viz Artist (--artist)</b>		
INSTALLDIR_ARTIST	%\Program Files%\vizrt\VizArtist	*
INSTALL_SHORTCUTS_DESKTOP	1	0, 1
INSTALL_SHORTCUTS_STARTMENU	1	0, 1
<b>Viz Engine (--engine)</b>		
INSTALLDIR_ENGINE	%\Program Files%\vizrt\VizEngine	*
INSTALL_SHORTCUTS_DESKTOP	1	0, 1
INSTALL_SHORTCUTS_STARTMENU	1	0, 1
<b>Viz Fsmon (--fsmon)</b>		
INSTALLDIR_FSMON	%\Program Files%\vizrt\Fsmon	*

<b>Viz Mediaftp (--mediaftp)</b>		
INSTALLDIR_MEDIAFTP	%\Program Files%\vizrt\Mediaftp	*

## Installed Components

<b>Component name</b>	<b>Value</b>	<b>Default</b>	<b>Setable via Bundle parameters</b>
<b>Viz Artist (--artist)</b>			
Documentation	CM_C_Documentation	Installed	Yes
Viz Artist	CM_C_VizArtist	Installed	Yes
<b>Viz Engine (--engine)</b>			
API Tools	CM_C_API.Tools	Installed	Yes
Cinema 4D LiveLink	CM_C_Cinema.4D.LiveLink	Not installed	Yes
Documentation	CM_C_Documentation	Installed	Yes
Maya FBX Export	CM_C_Maya.FBX.Export	Not installed	Yes
Plugin SDK	CM_C_Plugin.SDK	Installed	Yes
SNMP	CM_C_SNMP	Not installed	Yes
Viz Engine	CM_C_VizEngine	Installed	Yes
<b>Viz Fsmon (--fsmon)</b>			
Fsmon Service	CM_C_Fsmon.Service	Not installed	No
<b>Viz Mediaftp (--mediaftp)</b>			

MediaFtp Service	CM_C_Mediaftp.Service	Not installed	No
<b>Viz Plugins - AppearanceAdjustment (--plugins_appearanceadjustment)</b>			
VizPlugins	CM_C_VizPlugins	Not installed	Yes
Documentation	CM_C_Documentation	Not installed	Yes
<b>Viz Plugins - Basic (--plugins_basic)</b>			
Configs	CM_C_Configs	Installed	Yes
Documentation	CM_C_Documentation	Installed	Yes
VizPlugins	CM_C_VizPlugins	Installed	Yes
<b>Viz Plugins - DataPool (--plugins_datapool)</b>			
Configs	CM_C_Configs	Not installed	Yes
Documentation	CM_C_Documentation	Not installed	Yes
VizPlugins	CM_C_VizPlugins	Not installed	Yes
<b>Viz Plugins - Maps (--plugins_maps)</b>			
Configs	CM_C_Configs	Not installed	Yes
Documentation	CM_C_Documentation	Not installed	Yes
VizPlugins	CM_C_VizPlugins	Not installed	Yes
<b>Viz Plugins - PixelFx (--plugins_pixelfs)</b>			

VizPlugins	CM_C_VizPlugins	Not installed	Yes
Documentation	CM_C_Documentation	Not installed	Yes
<b>Viz Plugins - Socialize (--plugins_socialize)</b>			
Configs	CM_C_Configs	Not installed	Yes
Documentation	CM_C_Documentation	Not installed	Yes
Examples	CM_C_Examples	Not installed	Yes
VizPlugins	CM_C_VizPlugins	Not installed	Yes
<b>Vizrt Media UE x.yy (--vizrtmedia_uexyy)</b>			
Vizrt Media UEx.yy	CM_C_Vizrt.Media.UEx.yy	Not installed	Yes

### Example

Description	Command
<ul style="list-style-type: none"> <li>Install Viz Engine, and basic plug-ins in path <i>C:\Temp\Engine</i></li> <li>Install Viz Artist in path <i>C:\Temp\Artist'</i></li> </ul>	<pre>VizArtistBundle-x64-4.2.0.184.exe --silent --artist="INSTALLDIR_ARTIST='C:\Temp\Artist'" --engine="INSTALLDIR_ENGINE='C:\Temp\Engine'"</pre>
<ul style="list-style-type: none"> <li>Install Viz Engine, and basic plugins in path <i>C:\Program Files\vizrt\VizEngine</i>, Viz Artist in path <i>C:\Program Files\vizrt\VizArtist</i></li> <li>Install additional plug-in packages for DataPool, PixelFX, Socialize and Maps in path <i>C:\Program Files\vizrt\VizEngine</i></li> </ul>	<pre>VizArtistBundle-x64-4.2.0.184.exe --silent --engine="INSTALLDIR_ENGINE='C:\Program Files\vizrt\VizEngine'" --plugins_datapool="INSTALL_ME=true" --plugins_pixelfx="INSTALL_ME=true" --plugins_socialize="INSTALL_ME=true" --plugins_maps="INSTALL_ME=true"</pre>

## 5.2.7 To Identify Installed Version

To check the installed version of Viz Artist and Viz Engine, click on the **Viz Artist Information**

 button:

In the Information window, the version numbers show as:

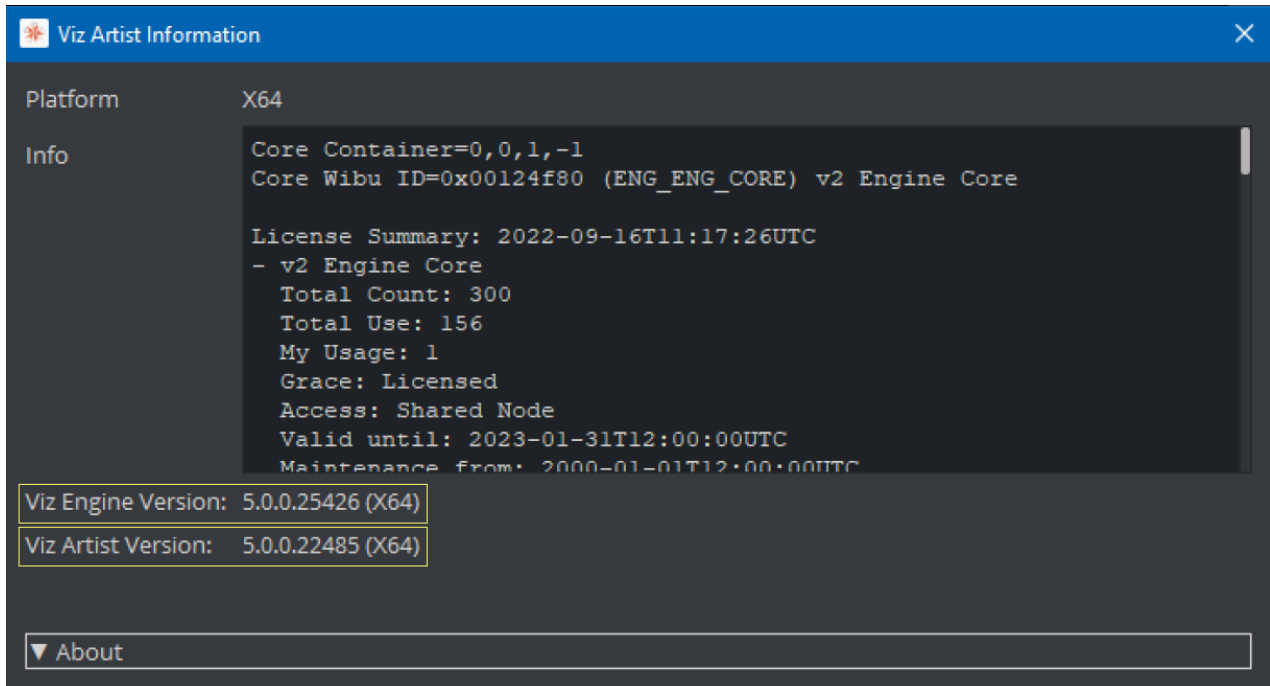

---

## 5.3 Viz Engine Folders

This section details the location of the Viz Engine default installation and data folders.

### 5.3.1 Installation Folders

The default installation folder is `C:\Program Files\Vizrt\VizEngine\`.

In this Administrator Guide, any reference to the Viz Engine installation folder, for example `C:\Program Files\Vizrt\VizEngine`, is replaced with the text `<viz install folder>`.

 **Note:** Viz Config files that already exist from a previous installation are automatically copied on install time if the installation folder did not change. If Viz Engine is installed in a different installation folder then Viz Config files must be manually copied from the old installation folder to `<viz data folder>`.

### 5.3.2 Data Folders

**Files which are created or modified** by Viz Engine are located at `%ProgramData%\Vizrt\VizEngine`, which usually resolves to `C:\ProgramData\Vizrt\VizEngine`. This folder is referenced as `<viz data folder>` throughout this Administrator Guide, and contains, for example:

- Viz Config files
- Script plug-ins
- Crash dump files

**Temporary files** are located at: `%TMP%\Vizrt\VizEngine`, which usually resolves to `C:\Users\<user name>\AppData\Local\Temp\Vizrt\VizEngine`. This folder is referenced as `<viz temp folder>` throughout this User Guide.

**Script Plug-ins** are located in the `<viz data folder>\ScriptPlugins` subfolder.

 **Note:** Script Plug-in files that already exist from a previous installation are automatically copied on install time if the installation folder did not change. If Viz Engine is installed in a different installation folder then Script Plug-in files must be manually copied from the old installation folder to `<viz data folder>\ScriptPlugins`.

## 5.4 Ports And Connections

This section contains information on the following topics:

- [Port Numbers](#)
  - [Viz Engine Ports](#)
  - [Other Integrations](#)
- [Multiplexing Ports](#)

### 5.4.1 Port Numbers

The table below lists all default server and listening port numbers used. When the firewall is well configured, it can be kept enabled. Client-side firewalls may cause issues when the Viz Artist/Viz Engine version is below 3.8.2 or the Graphic Hub version is below 3.0.0, since the communication protocol used was two-way and requires the firewall on the client side to be open for the Viz Artist/Viz Engine processes. However, it is not required to disable the firewall completely.

#### Viz Engine Ports

Service	Port(s)	Descriptions and comments
MVCP and Xlator control port for video servers. VDCP ports	5250 TCP	<div style="border: 1px solid #ffc107; padding: 5px; margin-bottom: 10px;"> <p> <b>Note:</b> This port is only necessary in combination with the video server extension (Service: AVCP).</p> </div> <p>These ports are configurable in Config File:</p> <ul style="list-style-type: none"> <li>• <code>MVCPServer_Port</code></li> <li>• <code>vdcp_controller[n]_port</code></li> </ul>
Tracking Hub communication	3000 UDP	<p>Used by Tracking Hub to communicate with Viz Engine.</p> <p>These ports are configurable in Config File:</p> <ul style="list-style-type: none"> <li>• <code>trackinghub_port</code></li> </ul>

Service	Port(s)	Descriptions and comments
Control Ports	<p>6100 TCP</p> <p>6700 TCP</p> <p>6800 TCP</p> <p>55000-55031</p> <p>31 TCP</p> <p>56000-56007</p> <p>15 TCP</p>	<p>Communication ports used by Control Applications (like Media Sequencer) to connect to a Viz Engine program and/or preview channel. Viz Engine's default program and preview port is 6100 .</p> <p>In a single channel configuration where both program and preview output is on the same machine, the default preview port is set to 6800 to separate the program and preview channels.</p> <p>In a dual channel configuration, the default program ports are 6100 and 6800 for channel one and channel two, respectively. In a dual channel configuration, when used for stereo production, the default program ports are 6700 and 6800 for channel one (left eye) and channel two (right eye), respectively.</p> <p>For controlling Graphics Channels and/or Super Channels, ports 55000-55031 and 56000-56007 are used (can be changed in the config).</p> <p>These ports are configurable via Config GUI.</p>
Viz Engine Unreal Integration	<p>6102 UDP</p> <p>6104 UDP</p> <p>6103 UDP</p>	<p>Communication ports from Viz Engine to Unreal Engine.</p> <p>These ports are configurable via Config GUI.</p>
Viz Artist	<p>6998, ...</p> <p>TCP</p>	<p>Used to communicate with Viz Artist. Every instance opens two ports, starting with 6998 and 6999 .</p> <div style="border: 1px solid orange; padding: 5px; margin-top: 10px;"> <p><b>⚠ Note:</b> These ports can not be changed!</p> </div>
Shared Memory Master Port	<p>freely configurable</p>	<p>These ports are configurable in Config File:</p> <ul style="list-style-type: none"> <li>• <code>smm_master_eng_port</code></li> </ul>
Command Feedback Port	<p>7476 UDP</p>	<p>Port to send feedback of commands. This port is configurable in Config File:</p> <ul style="list-style-type: none"> <li>• <code>command_feedback_port</code></li> </ul>



Service	Port(s)	Descriptions and comments
Viz Engine REST service	freely configurable TCP	To control Viz Engine via REST commands This port can be configed via Config GUI.
Extension Plugin Commands via Websockets	6900 TCP	To allow to control Viz Engine via a Websocket. This port can be changed manually in the JSON file <i>C:\ProgramData\vizrt\VizEngine\extensions\CommandOverWebsocket.json</i> .
Multitouch communication TUIO	3333 UDP	To connect to a TUIO multitouch service. This port is configurable in Config File: <ul style="list-style-type: none"> <li>tuio_serv</li> </ul>
Graphic Hub	19396-19398	Ports in use when connecting to different Graphic Hub components. Since Graphic Hub version 3.0.0 and Viz Artist/Viz Engine version 3.8.2, a limited number of open network ports is required. These do not require any port exemption rules on the client side firewall configuration. However, for earlier versions, all ports must be open on the client side.
MV Network Service	50000 TCP	responsible for NMOS requests. It might be necessary to manually add this exception to an existing firewall. netsh advfirewall firewall add rule name="Matrox NMOS API" protocol=TCP dir=in localport=50000 action=allow program="C:\ProgramFiles\Matrox DSX-TopologyUtils\System64\mvNetworkService.exe"
Multiplexer ports	50007 - 50009 TCP	<b>Multiplexing Ports</b> that enable Viz Engine to work on other scenes in sessions that are used for preview purposes.
	50007 TCP	<b>MUX Isolated port:</b> All connections to this port get their own session.
	50008 TCP	<b>MUX Shared port:</b> All connections from one single host shares one session.

Service	Port(s)	Descriptions and comments
	50009 TCP	<b>MUX Fixed port:</b> Same as shared port except that allocated resources are never cleared from memory.
	50010 TCP	<b>Still Preview port:</b> Enables a user to request a preview of the next scene to be put On Air while another scene is On Air.
These ports are configurable via Config GUI.		
WebRTC Extension Plugin	9092	Can be configured in the config file: <code>WebrtcOut1.WebsocketPort</code> or via command: <code>CONFIGURATION*CHANNELS*WEBRTCOUT_0*PORT SET &lt;port_number&gt;</code>

**Information:** Depending on your hardware (Matrox IP) in use, the number of ports can be much higher.

## Other Integrations



Listener	Port(s)	Descriptions and comments
Mediaftp	21	Used for video transfers from Viz One to Viz Engine.
Viz One	22	TCP and UDP for logging in to the Viz One operating system (Service: SSH).
Viz World Server	102 103	102 (TCP) is a Viz World Server listener port for Viz World Client connections when Server Allocator is not in use or only has one Viz World Server running. 103 (TCP) is a Viz World Server listener port for configuration tool connections to the first Viz World Server instance (as configurations are controlled by the first server instance). See also Vizrt Maps.
Viz One	137 139	Used for SMB file sharing (Service: Netbios)
Viz One, Microsoft Bing and Imagery on Demand	80 8080	Web interface and client software. SOAP port for communication with Viz One. For download of Microsoft Bing and Imagery on Demand images (Service: HTTP).

Listener	Port(s)	Descriptions and comments
OpenSLP	427	Service Location Protocol (SLP) based discovery and search (TCP, UDP).
Viz One	443 445	(Service: HTTPS) TCP and UDP used for SMB file sharing (Service: Microsoft-DS).
Viz One Delivery	554	Real-time Streaming Protocol (Service: TCP).
Oracle database	152 1	For clients that connect to the Viz Pilot Database.
Viz One	308 0	Low resolution video and index files (Service: lighttpd).
Viz Trio	620 0 621 0	6200 is used for controlling the Viz Trio client over a socket connection. 6210 is used by the Graphics Plug-in to establish a connection to Viz Trio.
Newsroom Component	622 0	Used by the Graphics Plug-in to establish a connection to Viz Pilot's Newsroom client.
Graphics Plugin Editor	623 0	Used by the Graphics Plug-in to establish a connection to the Graphics Plug-in Editor (on Mac).
Graphics Plugin Config	624 0	Used by the Graphics Plug-in to establish a connection to the Graphics Plug-in Configuration tool (on Mac).
Viz Ticker Service	630 0 630 1	Viz Ticker handler in the Media Sequencer connects to port 6300 for feedback from Viz Ticker Service. Viz Ticker handler in the Media Sequencer connect to port 6301 when controlling Viz Ticker via a socket connection.

Listener	Port(s)	Descriptions and comments
Viz Pilot	6484	Socket connection used for controlling Viz Pilot using macro commands.
Viz One	6555	Message bus port for communication with Viz One (Service: Message bus).
Preview License server	7452	For the Newsroom Component using an unlicensed Viz Engine for local preview with a connection to the Preview License server (is not the same as the Preview Server).
Viz Pilot Data Server	8177	Used to connect over HTTP with the REST interface.
Media Sequencer	8580 8594	For clients connecting to the Media Sequencer. 8580 is specifically used to connect over HTTP with the REST interface.
Viz One	8080	Used for sending key frames (Service: ardok).
Gateway	10001 10002 10540 10541	For DB notification events. For Gateway controller clients. For MOS object updates. For MOS playlist updates.

Listener	Port(s)	Descriptions and comments
Viz World Server	10100 10200	<p>10100 (TCP) is a Server Allocator listener port for Viz World Client connections, and is only used for clients to get connection details about Viz World Server(s). The first client connection is always diverted to port 102. In case of multiple server instances, port numbers are assigned according to a predefined schema ( 10101 , 10102 for server instance two and three and so on). In case there is no Server Allocator, Viz World Server itself switches to port 102 .</p> <p>10100 (UDP) is a Viz World Server listener port for Server Allocator communication.</p> <p>10200 (UDP) is a Server Allocator listener port for Viz World Server communication. Both UDP ports are internal ports used between the servers. For more information, please see the Viz World Client and Server 11.1 User Guide and later.</p>
Viz Pilot	10640	Used by Gateway to establish a connection to Viz Pilot to send and receive updates on MOS messages (for example, items and playlists).
Graphic Hub	19396-19398	Ports in use when connecting to different Graphic Hub components. Since Graphic Hub version 3.0.0 and Viz Artist/Viz Engine version 3.8.2, a limited number of open network ports is required. These do not require any port exemption rules on the client side firewall configuration. However, for earlier versions, all ports must be open on the client side.
Connection Broker	21098	Connection to the Connection Broker configuration interface (for example, <a href="http://localhost:21098/">http://localhost:21098/</a> ).
Preview Server	54000	Used to connect over HTTP with the REST interface.
Codometer Webinterface	22352	To configure the Codometer runtime via WebInterface.

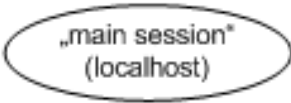
## 5.4.2 Multiplexing Ports

Ports	Viz Engine
All other ports	
Still Preview Port	
MUX Isolated Port MUX Shared Port MUX Fixed Port	

The multiplexer functionality is an integral part of Viz Engine. When using Viz Engine a session management takes place internally, with one default session for the GUI and internal/external commands, and additional sessions created on-demand for the multiplexing ports or the preview port.

With multiplex ports, other than the MUX Still Preview port, the Viz Engine state is only switched when a command is received, which means a new session is created; hence, ten consecutive commands from a client only results in one state switch on the first command.

- The MUX Still Preview Port ( 50010 ) state is switched when a command is received and immediately switched back to the main session such that On Air rendering is not hindered in any way.
- The MUX Fixed Port ( 50009 ) is traditionally used by the old Viz Pilot Newsroom Client, and is the same as the MUX Shared Port, except that allocated resources are never cleared from memory. To avoid memory overload, it is recommended to clean up the Viz Engine regularly when this port is used.

**Info:** There is no automated cleanup of memory on this port.

- The MUX Shared Port ( 50008 ) is a shared port where all connections from one single host shares one session. It is most often used by Viz Trio and the Newsroom Client to show preview frames.
- The MUX Isolated Port ( 50007 ) is an isolated port where all connections get their own session. It is used, for example in an NLE configuration, to deliver frames to the host NLE-system when rendering or scrubbing video clips with graphics. Using this port also suppresses bounding box commands.

All multiplexing ports are supported by all Viz Engine versions, but require a license.

## 5.5 Viz Log Files

All Viz Artist/Engine log files are located in the *<viz data folder>*.

**Note:** This is normally at `C:\ProgramData\Vizrt\VizEngine` Check the directory name with the command `echo %programdata%` from a Windows command prompt. This directory is by default hidden in Windows, so to navigate to this directory in Windows Explorer specify the explicit path.

Viz Artist/Engine can provide various log files as documented in the section below.

### 5.5.1 Viz Render Log

- **Name:** *VizRender\_<timestamp>.log*
- **Purpose:** Provides information on current status of Viz Engine.

### 5.5.2 Viz Trace Log

- **Name:** *VizTrace\_<timestamp>.vlog*
- **Purpose:** Provides command trace that facilitates playback for error reproduction, contains at most the last 500 commands.

### 5.5.3 Viz Gui Log

- **Name:** *VizGui.log*
- **Purpose:** Provides information on Viz GUI errors.
- **Log Description:** Each line in the log file has six components or entries, each separated by pipe (|). A typical log-line looks like:

```
Thu Jul 04 10:02:15 EST 2019|LM_ART|5420|Version: 4.0.1.42057|CONFIG|GPU1
```

The components for each log-line are:

- Date/time
- Type, one of:
  - LM\_STARTUP (Regular startup)
  - LM\_QUIT (Regular quit)
  - LM\_QUIT\_TIMEOUT (Timeout quit)
  - LM\_QUIT\_LOGIN (Login canceled)
  - LM\_CFG (Restart with configuration)
  - LM\_ENG\_GUI (Restart engine with GUI)
  - LM\_ENG (Restart engine without GUI)
  - LM\_ART (Restart of Artist)
  - LM\_ (Current mode restarted)

- Pid (Process id)
- Viz version
- Mode:
  - CONFIG (Config Mode)
  - NOGUI (Engine Mode)
  - NORMAL (Artist Mode)
- Starting on GPU<x>, for example *GPU1* (Graphical Processing Unit number one)

### 5.5.4 Viz Shaders Log

- **Name:** *VizShaders.log*
- **Purpose:** Provides information on shader compilation.

### 5.5.5 Viz Console Log

- **Name:** *Viz\_<timestamp>.log*
- **Purpose:** Logs console output to a file when the engine is started without console ( `-C` option).

### 5.5.6 Viz GUI Connection Log

This Log is created if *Write GH Connection Log* is active (see [Local Settings](#)).

- **Name:** *VizGuiConnection<timestamp>.log*
- **Purpose:** Provides information on the Graphic Hub Manager database connection.

### 5.5.7 Create Log Files with Log and Clog Commands

The output of the Viz Engine can be redirected to a file using the command `log <filename>`, for example, `log C:\temp\my-engine-log.txt`. Note that the log file has no content until the Viz Engine in-memory buffers are flushed, meaning written to disk. The log memory buffers are flushed to disk either when the buffer are full or when Viz Engine quits. You can force the buffer to be written to the log file on disk by sending the command: `CONSOLE FLUSH`.

You can take an immediate snapshot of the Engine's current in-memory log with the command `clog`. A new log file is immediately written to `<viz data folder>\VizRender-ID.log`. The ID in the filename is the GPU ID, making it easy to differentiate log files in a Dual Engine setup for example.

Both the **log** and **clog** commands can be executed by sending them to Viz or by entering them directly in the Engine Console window.

Click on the  (show commands) button to access the Console window.



## 5.6 Logfiles Configuration

- [Location of Log Configuration](#)
- [Concept of Log Configuration](#)
  - [Known Sinks](#)
    - [Parameters Common To All Sinks](#)
    - [daily\\_file\\_sink](#)
    - [rotating\\_file\\_sink](#)
    - [stdout\\_color\\_sink](#) and [stderr\\_color\\_sink](#)
  - [Known Formatters](#)
    - [Parameters Common To All Formatters](#)
    - [pattern\\_formatter](#)
  - [Logger](#)
  - [Known Loggers in the Viz Engine](#)
- [Built-In Log Config](#)
- [Examples](#)
  - [Log to File only](#)
  - [Only Warning and Errors on Console](#)

### 5.6.1 Location of Log Configuration

Viz Engine Log Configuration is stored in *.json* files. Viz Engine is looking in its *ProgramData* folder for log configuration files. By default this folder is located at `%ProgramData%\vizrt\VizEngine` if not changed by command line argument. Viz Engine looks for a file called `viz_engine_%N_log_config.json`, where `%N` is replaced by the instance number, starting at 0 for the first instance. If that file is not found it tries `viz_engine_log_config.json` next. In case that also fails the last resort is the built-in log configuration.

This approach allows to have distinct log configuration for each Viz Engine instance or a common one for all instances, depending on the use case, one or the other might be preferred.

#### **Order of Log Configuration Search:**

- `${ProgramData}\viz_engine_%N_log_config.json`
- `${ProgramData}\viz_engine_log_config.json`
- built-in as fallback

### 5.6.2 Concept of Log Configuration

The Log Configuration consists of loggers who contain zero, one, or more sinks. A sink uses a formatter. The application knows loggers by its ID. A sink used by a logger determines the destination where a log record is sent to and a formatter is used to process the log record to bring it to the desired format expected by the sink.

#### **Log configuration Concept Overview:**

```

Formatters: [ formatter1 , formatter2, ...]
formatter1 : {id, concrete_type}, ...
Loggers: [ logger1 , logger2, ...]
logger1 : {id, sinks: [ sink1 , sink2, ...]}, ...
sink1 : {id, formatter1, concrete_type}, ...

```

 **Warning:** Only the formatters and sinks listed below are supported. Using other formatters or sinks result in undefined behavior!

## Known Sinks

At the moment there are four sinks available. Two file sinks and two console sinks.

- **daily\_file\_sink:** Creates a log file that is daily rotated.
- **rotating\_file\_sink:** Creates a log file that is rotated when it exceeds a certain size.
- **stdout\_color\_sink:** Creates a colored console sink writing on stdout.
- **stderr\_color\_sink:** Creates a colored console sink writing on stderr.

## Parameters Common To All Sinks

Some parameters are common to all concrete sinks and are described below.

 **Parameters Common To All Sinks:**

```

" id " : "default_file_sink" ,
" formatter " : "engine_file_formatter" ,
" log_level " : "debug" ,
" deferred " : false ,

```

- **id:** Determines identifier for this sink. This ID is used by the application.
- **formatter:** References an id of a formatter.
- **log\_level:** Applies a log level to this sink. Possible values are:
  - trace
  - debug
  - info
  - warning
  - error
  - critical
  - off
- **deferred:** Does not create this sink during configuration. It may later be instantiated by the application.

## daily\_file\_sink

Creates a log file that is rotated daily. The concrete parameters are below.

 **Daily file sink: Concrete parameters:**

```
"daily_file_sink" : {
  " base_filename " : "logs/viz_engine_%N_default" ,
  " rotation_hour " : 9 ,
  " rotation_minute " : 3 ,
  " truncate " : false,
  " max_files " : 10
}
```

- **base\_filename:** Determines the path and name of your log file. It may include a placeholder for instance as %N. Path can be absolute or relative. If path is relative, then it is always relative to the current directory. Creates filename in the form *basename.YYYY-MM-DD*.
- **rotation\_hour:** Rotates at this hour. Range 0-23. Do not include a leading zero.
- **rotation\_minute:** Rotates at this minute. Range 0-59. Do not include a leading zero.
- **truncate:** Empties the log file at start or reconfiguration of this sink, if set to *true*.
- **max\_files:** Determines the maximum number of files to keep after rotating.

### rotating\_file\_sink

Creates a log file that is rotated when it exceeds a certain size. The concrete parameters are below.

#### Rotating file sink: Concrete parameters:

```
"rotating_file_sink" : {
  " base_filename " : "logs/viz_engine_%N_shaders" ,
  " max_size_MB " : 1024 ,
  " max_files " : 8 ,
  " rotate_on_open " : false
}
```

- **base\_filename:** Determines path and name of your log file. It may include a placeholder for instance as %N. Path can be absolute or relative. If path is relative, then it is always relative to the current directory.
- **max\_size\_MB:** Sets the maximum size in MB after which file gets rotated.
- **max\_files:** Determines the maximum number files to keep after rotating.
- **rotate\_on\_open:** Rotates the log file at start or reconfiguration of this sink, if set to *true*.

### stdout\_color\_sink and stderr\_color\_sink

Creates a colored console sink writing on stdout or stderr. Since they are identical they are gathered together here in the documentation. The concrete parameters are below.

#### stdxxx color sink: Concrete parameters:

```
"stdout_color_sink" : {
  " color_mode " : "automatic"
}
"stderr_color_sink": {
  " color_mode ": "automatic"
}
```

- **color\_mode:** Sets the color mode used by sinks with color support. Possible values are:
  - automatic
  - always
  - never

## Known Formatters

At the moment there is one formatter known.

- **pattern\_formatter:** A highly versatile text formatter.

## Parameters Common To All Formatters

**Parameters Common To all Formatters:**

```
" id " : "engine_file_formatter" ,
```

- **id:** Sets the identifier for this formatter. This ID is used as a reference by a sink.

## pattern\_formatter

A highly versatile text formatter.

**Pattern formatter: Concrete parameters:**

```
"pattern_formatter" : {
  " pattern_string " : "[%Y-%m-%dT%H:%M:%S.%fZ] [%l] [pid=%P] [tid=%t]:
  %a %v" ,
  " pattern_time_type " : "utc" ,
  " eol " : "default" ,
  " enterprise_id " : "27566.3.1.%N" ,
  " sd_id_fallback " : "renderer" ,
  " escape_nl " : true ,
  " attr_flag_formatter " : "a",
  " attr_prefix " : ""
}
```

- **pattern\_string:** Describes how to format the log message. Placeholders in the string expand to.
  - "%n" logger name.
  - "%l" log level.
  - "%L" short log level.
  - "%a" weekday. THIS FLAG HAS BEEN RE\_PURPOSED TO
  - "%a" viz::log::attributes
  - "%A" short weekday.
  - "%b" or "%h" month.
  - "%B" short month.
  - "%c" datetime.
  - "%C" year two digits.
  - "%Y" year four digits.
  - "%D" or "%x" datetime MM/DD/YY.
  - "%m" month 1-12.
  - "%d" day of month 1-31.
  - "%H" hours 24.
  - "%I" hours 12.
  - "%M" minutes.
  - "%S" seconds.
  - "%e" milliseconds.
  - "%f" microseconds.
  - "%F" nanoseconds.
  - "%E" seconds since the epoch.
  - "%p" am/pm.
  - "%r" 12 hour clock 02:55:02 pm.
  - "%R" 24-hour HH:MM time.
  - "%T" or "%X" ISO 8601 time format (HH:MM:SS).
  - "%z" timezone.
  - "%t" thread id.
  - "%P" pid. see
  - "%v" message text.
  - "%^" color range start.
  - "%\$" color range end
  - "%@" source location (filename:linenumber).
  - "%s" short source filename - without directory name.
  - "%g" full source filename.
  - "%#" source line number.

- "%!" source funcname.
- "%%" "%" char.
- "%u" elapsed time since last log message in nanoseconds.
- "%i" elapsed time since last log message in microseconds.
- "%o" elapsed time since last log message in milliseconds.
- "%0" elapsed time since last log message in seconds.

Some placeholders may not be available and depend on the log component itself, such as source location, funcname, etc. This is not a defect, but intentional.

- **pattern\_time\_type:** Determines how the time is presented. Possible values are:
  - local
  - utc
- **eol:** string to append at the end of the log message. Possible values are:
  - default ... the default value for end of line on your OS
  - LF ... line feed
  - CR ... carriage return
  - CRLF ... carriage return followed by line feed
  - "none" ... nothing will be appended
- **enterprise\_id:** Sets the IANA enterprise ID to use together with the sd\_id attribute. It is good practice to leave it to the configured value to be able to identify log messages later on.
- **sd\_id\_fallback:** Sets a fallback for the sd\_id attribute if the attribute needs to be emitted but is not explicitly provided in the log message.
- **escape\_nl:** Escapes CR and LF in the log message, if true.
- **attr\_flag\_formatter:** Determines the character in the pattern\_string that selects the attributes formatter.
- **attr\_prefix:** Sets a string that is printed before each attributes formatter.

## Logger

### Logger: Parameter

```
"logger": {
  "id": "engine_sync_console",
  "log_level": "info",
  "flush_level": "error",
  "async_mode": true,
  "register": true,
  "deferred": false,
  "dup_filter_max_skip_duration": 0,
  "sinks": [ ... ]
}
```

- **id:** Determines identifier for this logger. This ID is used by the application.
- **log\_level:** Applies a log level to this logger. Possible values are:
  - trace
  - debug

- info
  - warning
  - error
  - critical
  - off
- **flush\_level:** Flushes this logger on all sinks when a log message with this level or higher is logged. Possible values are:
    - trace
    - debug
    - info
    - warning
    - error
    - critical
    - off
  - **async\_mode:** Operates the logger asynchronously.
  - **register:** Registers the logger in the logger registry if true.
  - **deferred:** Does not create this logger by default. It is instantiated later by the application.
  - **dup\_filter\_max\_skip\_duration:** Determines the time interval (in seconds) within which duplicate payloads are filtered out when greater than zero.
  - **sinks:** Lists sinks for this logger. See below in the Built-In Log Config for details.

## Known Loggers in the Viz Engine

The Viz Engine uses the following loggers:

### Known Loggers to Viz Engine:

- engine\_default
- engine\_sync\_console
- engine\_shaders

- **engine\_sync\_console:** Answers to input read from the console is using the synchronous console logger.
- **engine\_shaders:** Emits shader construction to this logger.
- **engine\_default:** All other log messages end up here.

## 5.6.3 Built-In Log Config

### Viz Engine Built-in Log Configuration

```
{
  "version": "1.0",
  "async_params": {
    "queue_size": 32768,
    "overflow_policy": "overrun_oldest",
    "number_of_workers": 1,
  }
}
```

```

    "flush_interval": 10
  },
  "formatters": [
    {
      "id": "engine_file_formatter",
      "concrete": {
        "pattern_formatter": {
          "pattern_string": "[%Y-%m-%d %H:%M:%S.%fZ] [%l][pid=%P][tid=%t]: %a %v",
          "pattern_time_type": "utc",
          "eol": "default",
          "enterprise_id": "27566.3.1.1.%N",
          "sd_id_fallback": "renderer",
          "escape_nl": true,
          "attr_flag_formatter": "a"
        }
      }
    },
    {
      "id": "engine_console_formatter",
      "concrete": {
        "pattern_formatter": {
          "pattern_string": "%^[%Y-%m-%d %H:%M:%S.%e] [%L]:%$ %v%a",
          "pattern_time_type": "local",
          "eol": "default",
          "enterprise_id": "",
          "sd_id_fallback": "",
          "escape_nl": false,
          "attr_flag_formatter": "a",
          "attr_prefix": "\\n\\t"
        }
      }
    },
    {
      "id": "plain_console_formatter",
      "concrete": {
        "pattern_formatter": {
          "pattern_string": "%v",
          "pattern_time_type": "local",
          "eol": "default",
          "enterprise_id": "",
          "sd_id_fallback": "",
          "escape_nl": false
        }
      }
    }
  ],
  "loggers": [
    {
      "logger": {
        "id": "engine_default",
        "log_level": "info",
        "flush_level": "error",

```



```

"async_mode": true,
"register": true,
"deferred": false,
"dup_filter_max_skip_duration": 0,
"sinks": [
  {
    "id": "default_file_sink",
    "formatter": "engine_file_formatter",
    "log_level": "debug",
    "deferred": false,
    "concrete": {
      "rotating_file_sink": {
        "base_filename": "logs/viz_engine_%N_default",
        "max_size_MB": 1024,
        "max_files": 10,
        "rotate_on_open": false
      }
    }
  },
  {
    "id": "console_sink",
    "formatter": "engine_console_formatter",
    "log_level": "debug",
    "deferred": true,
    "concrete": {
      "stdout_color_sink": {
        "color_mode": "automatic"
      }
    }
  }
]
},
{
  "logger": {
    "id": "engine_sync_console",
    "log_level": "info",
    "flush_level": "error",
    "async_mode": false,
    "register": false,
    "deferred": false,
    "dup_filter_max_skip_duration": 0,
    "sinks": [
      {
        "id": "sync_console_sink",
        "formatter": "plain_console_formatter",
        "log_level": "debug",
        "deferred": true,
        "concrete": {
          "stdout_color_sink": {
            "color_mode": "automatic"
          }
        }
      }
    ]
  }
}

```

```

    }
  }
]
},
{
  "logger": {
    "id": "engine_shaders",
    "log_level": "info",
    "flush_level": "info",
    "async_mode": true,
    "register": true,
    "deferred": true,
    "dup_filter_max_skip_duration": 0,
    "sinks": [
      {
        "id": "shader_file_sink",
        "formatter": "engine_file_formatter",
        "log_level": "info",
        "deferred": false,
        "concrete": {
          "rotating_file_sink": {
            "base_filename": "logs/viz_engine_%N_shaders",
            "max_size_MB": 1024,
            "max_files": 10,
            "rotate_on_open": false
          }
        }
      }
    ]
  }
}
]
}
}

```

The first object contains the parameters for the default asynchronous factory. Followed by three formatters, `engine_file_formatter`, `engine_console_formatter`, and `plain_console_formatter`. The last one just emits the log message as it was received. No other decoration, such as timestamps are added. The former two add timestamps and the `engine_console_formatter` does colorization where possible.

On the loggers side we have `engine_default`, which has a `log_level` of `info`, is using the asynchronous factory and is created during the initial configuration. It uses two sinks, a `rotating_file_sink` logging to `logs/viz_engine_%N_default`, and `stdout_color_sink` to emit logs messages to the console. Next is `engine_shaders`, it uses a `rotating_file_sink` as well and the same formatter as `engine_default`. It is not created at configuration time but on demand. Next is `engine_sync_console`, it is created at configuration time, does not register itself and the sink is created deferred. Meaning the logger can be found but the sink is created on demand.

## 5.6.4 Examples

### Log to File only

If one does not want any messages emitted onto the console window the console sink can just be omitted from the engine\_default logger. Such as:

#### Example: Log to file only:

```
{
  "logger" : {
    "id" : "engine_default" ,
    "log_level" : "info" ,
    "flush_level" : "error" ,
    "async_mode" : true ,
    "register" : true ,
    "deferred" : false ,
    "dup_filter_max_skip_duration": 0,
    "sinks" : [
      {
        "id" : "default_file_sink" ,
        "formatter" : "engine_file_formatter" ,
        "log_level" : "debug" ,
        "deferred" : false ,
        "concrete" : {
          "rotating_file_sink" : {
            "base_filename" : "logs/viz_engine_%N_default" ,
            "max_size_MB" : 1024 ,
            "max_files" : 10 ,
            "rotate_on_open" : false
          }
        }
      }
    ],
    {
      "id" : "console_sink" ,
      "formatter" : "engine_console_formatter" ,
      "log_level" : "debug" ,
      "deferred" : true ,
      "concrete" : {
```

```

    "stdout_color_sink" : {
      "color_mode" : "automatic"
    }
  }
]
}
}

```

## Only Warning and Errors on Console

Sometimes it may be beneficial if only warning and error appear in the console. For this just set the `log_level` in the console sink to `warning`.

### **i** Example: Only warning and error in console:

```

{
  "logger" : {
    "id" : "engine_default" ,
    "log_level" : "info" ,
    "flush_level" : "error" ,
    "async_mode" : true ,
    "register" : true ,
    "deferred" : false ,
    "dup_filter_max_skip_duration": 0,
    "sinks" : [
      {
        "id" : "default_file_sink" ,
        "formatter" : "engine_file_formatter" ,
        "log_level" : "debug" ,
        "deferred" : false ,
        "concrete" : {
          "rotating_file_sink" : {
            "base_filename" : "logs/viz_engine_%N_default" ,
            "max_size_MB" : 1024 ,
            "max_files" : 10 ,
            "rotate_on_open" : true
          }
        }
      }
    ]
  }
}

```

```
    },  
    {  
      "id" : "console_sink" ,  
      "formatter" : "engine_console_formatter" ,  
      "log_level" : "warning" ,  
      "deferred" : true ,  
      "concrete" : {  
        "stdout_color_sink" : {  
          "color_mode" : "automatic"  
        }  
      }  
    }  
  ]  
}  
}
```

## 5.7 Supported Software

### 5.7.1 Viz Engine Software

To run Viz Engine as a program or preview (optional) machine, the following software and configuration is needed:

#### Viz Engine Specifications

Category	Requirement
Software	<ul style="list-style-type: none"> <li>• Installation of latest Viz Artist/Viz Engine package</li> <li>• Optional: (Additional plug-in packages)</li> <li>• Codemeter runtime for WIBU-based licensing</li> </ul>
Hardware	Valid Codemeter license Supported GPU and videoboard
Executable(s)	<i>viz.exe</i>
Ports and Connections	<ul style="list-style-type: none"> <li>• See Ports and Connections</li> </ul>

**Info:** The Viz Engine Render Pipeline requires at least an NVIDIA Quattro P6000 GPU.

### 5.7.2 Preview Server

The Preview Server option is used in situations where Viz Engine is used to provide frames for snapshot or thumbnail generation. A typical use case would be to connect multiple Newsroom Components to a preview server.

The Preview Server must be installed on a separate Viz Engine machine with its own license.

Category	Requirement
Software	<ul style="list-style-type: none"> <li>• Latest Preview Server package</li> <li>• Microsoft .NET Framework 4</li> <li>• Latest Viz Artist/Viz Engine package</li> <li>• Codemeter runtime for WIBU-based licensing</li> </ul>
Hardware	Codemeter license Supported GPU
Executable(s)	<i>PreviewServer.exe</i>

Category	Requirement
Ports and Connections	54000 : Used to connect over HTTP with the REST interface.
Network access	Uses the ZeroConf protocol to announce available services.

### 5.7.3 Viz Artist Software

The Viz Artist design machine should preferably have the same specifications as the Viz Engine playout renderer, especially if the designers need to test performance issues on demanding scenes.

Category	Requirement
Software	<ul style="list-style-type: none"> <li>• Installation of latest Viz Artist/Viz Engine package</li> <li>• Optional: (Additional plug-in packages)</li> <li>• Codemeter runtime for WIBU-based licensing</li> </ul>
Hardware	Valid Codemeter license Supported GPU and videoboard
Executable(s)	<i>vizgui.exe</i>
Ports and Connections	See Ports and Connections.

If designers are creating templates for Viz Pilot, it is recommended that Viz Pilot is installed on a separate machine for more accurate playout emulation on Viz Engine.

## 5.8 Import And Export Formats

Format	Importable (with/without compression)	Exportable	Supported by Viz Classic Render Pipeline	Supported by Viz Engine Render Pipeline
BMP	✓	✓	✓	✓
PNG <sup>1</sup>	✓	✓	✓	✓
TGA	✓	✓	✓	✓
JPEG	✓	✓	✓	✓
HDR <sup>2</sup>	✓	✓	✓	✓
EXR	✓	✗	✓	✓
VBN <sup>3</sup>	✓	✗	✓	✓
TIF	✓	✓	✓	✓
PSD <sup>4</sup>	✓	✓	✓	✓
GIF	✓	✗	✓	✓

1. No support for 16-bit per channel PNG images.  
 2. For use with RTT plug-in or as Environment Maps in Viz Engine Render Pipeline.  
 3. Compressed images are not supported.  
 4. Layered PSDs are imported as separate images.

### 5.8.1 EXIF

EXIF information is read when importing JPEG images. Images are automatically rotated based on the rotation information stored within the image.



## 5.9 Viz Engine REST Interface

**REST** (short for Representational State Transfer) is an architectural paradigm for distributed systems, such as web services. Broadly spoken, REST relates to HTTP in the sense XML relates to HTML; a paradigm of the general concepts behind HTTP with some added restrictions. One such constraint is the statelessness of the communication; which HTTP violates via cookies. The most widely known application of REST, are web pages accessed via HTTP. Each web page is a unique resource, accessed via its URL (Uniform Resource Locator) which can be operated on (for example, `GET /books/dune.html`). This combination of operation and URL is called a message. In REST, a message has to be self-descriptive, meaning that all the information needed to process the message is required to be contained within the message.

The Viz Engine REST interface can be activated by enabling **Webservice** in the Global tab of the [Communication](#) section of [Configuring Viz](#).

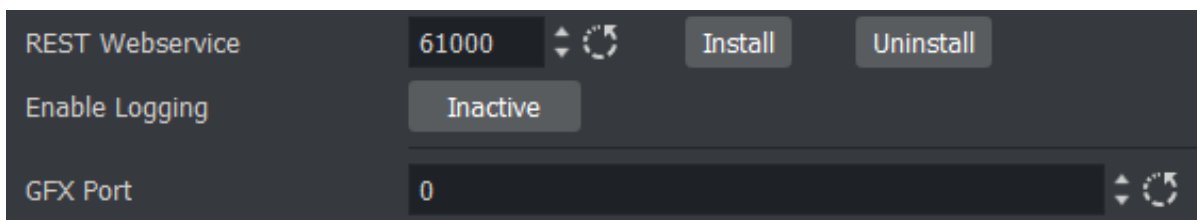

If [User Account Control](#) is active, press **Install** after setting the Port. The default port for the Viz Engine web service is `61000`. After restarting Viz, the REST interface can be accessed by navigating a web browser to <http://localhost:61000>. The landing page displays the status of the Engine, with information on which mode it is running in and its version number.

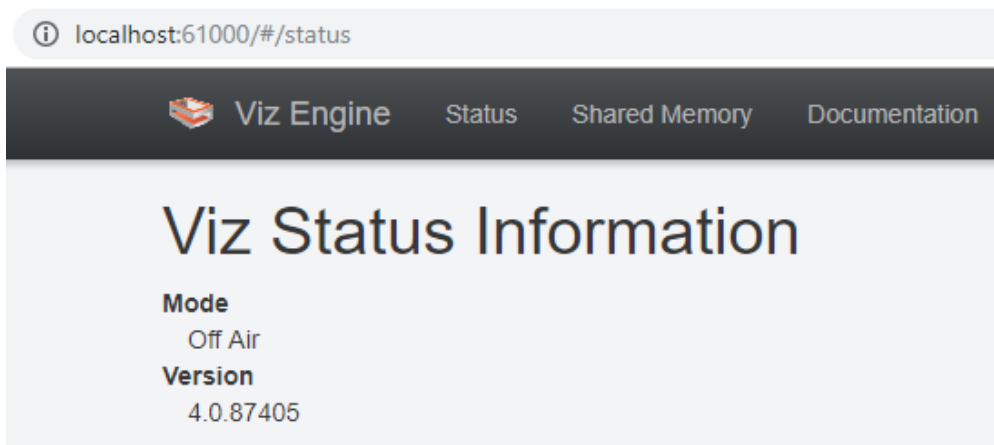

Once the REST interface has been activated, the complete documentation for the Viz Engine REST interface can be accessed by navigating to <http://localhost:61000/#/documentation>, or by clicking the **Documentation** link from the landing page.

---

## 5.10 User Account Control

Since version 3.7.1, Viz Artist/Viz Engine is UAC aware. This means Viz Artist/Viz Engine can run when UAC is enabled on the computer.

**✘ IMPORTANT!** UAC configuration is the responsibility of the individual company's own IT policy.

When UAC is enabled, an additional confirmation prompt shows when these items are installed or removed:

- Viz Artist/Viz Engine
- Viz One Services (Mediaftp or fsmon)
- The web service for the [Viz Engine REST Interface](#)

When UAC settings are modified, a reboot is required. Viz Artist/Viz Engine and all plug-ins shipped with the Viz Artist installer are UAC aware. However, if other plug-ins are used, a warning message may be displayed during Viz Engine startup:

**✘ WARNING:** The plug-in *<plugin-name>.vip* may not be UAC aware. Contact your plug-in vendor for an updated version.

This warning means that the plug-in may not work correctly if UAC is enabled. For example, the plug-in might attempt to write into the installation folder, which is not allowed anymore. Contact the plug-in vendor for information on the UAC awareness of the plug-in.

**✘ IMPORTANT!** Even though the warning shows, the plug-in is still loaded on startup.

Most changes result from the UAC requirement that an application must not write into the installation folder.

## 5.11 NDI

The NDI protocol is built in natively into Viz Engine. It can be used in combination with a Matrox topology board or in pure Software I/O mode. Other video boards are not supported.

### 5.11.1 NDI Input

To receive NDI streams, set the type of a Live input channel to NDI and select an NDI source. This is done **Configuration > Video Input: Live Input**. The NDI source can also be changed with the NDI control plug-in. The NDI stream can be used as a regular live input.

Channel	Type
Live Channel 1	IP
Live Channel 2	NDI
Live Channel 3	Inactive
Live Channel 4	Inactive
Live Channel 5	Inactive
Live Channel 6	Inactive
Live Channel 7	Inactive
Live Channel 8	Inactive
Live Channel 9	Inactive
Live Channel 10	Inactive
Live Channel 11	Inactive
Live Channel 12	Inactive
Live Channel 13	Inactive
Live Channel 14	Inactive
Live Channel 15	Inactive
Live Channel 16	Inactive

Video System: Auto

**Audio Settings**

Enable Audio:

Delay Texture: 3

**Ndi Settings**

Enable Alpha:

Source: PTZ3UHD-560575 (Channel 1)

None

PTZ3UHD-560575 (Channel 1)

If at least one NDI input is configured during startup, Viz Engine scans the network for NDI senders. All discovered sources are shown in the drop down menu.

**Note:** If a source can not be discovered, install the NDI tools and manually add the source by using the NDI Access Manager.

The configured input video system is only used as the initial value. At runtime, Viz Engine dynamically adapts to changes in the resolution and frame rate of the NDI input stream.

NDI senders are generally not synced and run at slightly different frequencies. To compensate for these differences, Viz Engine skips or repeats NDI input frames as necessary to make playback as smooth as possible.

**Note:** The maximum number of inputs is limited by the network capabilities and the resolution. Usually two 1080p inputs on a dedicated network are realistic.

If the alpha channel of the NDI input signal needs to be considered, *Enable Alpha* needs to be turned on.

## 5.11.2 NDI Output

The Viz Engine output registers itself as NDI stream if a valid license is available and configured and the output is enabled in the Viz Configuration File. The name of the NDI sender is *VizEngine-N*, where *N* is the instance number.

**Information:** To use NDI output in combination with Matrox boards, it has to be explicitly enabled by setting `NdiOut1.Enable = 1` in section **CHANNELS\_CONFIG** in your Viz Configuration File. In Software I/O Mode NDI (see below) this the NDI output is enabled by default and can be disabled by setting `NdiOut1.Enable = 0`.

By default the NDI output of Viz Engine is a fill and key signal. To send fill only, set "`NdiOut1.ContainsAlpha = 0`" in the configuration file.

## 5.11.3 NDI in Software I/O Only Mode

To configure Viz Engine using NDI without any video board:

- Uncheck *User Defined* in Check Video Card.
- Set the Software I/O Mode to **NDI**.
- Live inputs can then be mapped to NDI sources in **Configuration > Video Input: Live Input**.

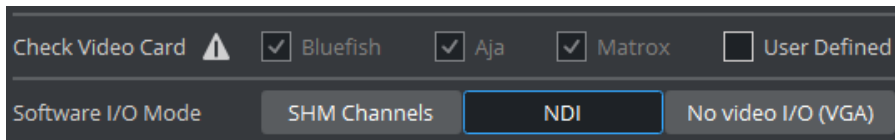

## 5.11.4 SDK Versions

The following table lists the SDK version Viz Engine is built with:

Viz Engine	NDI SDK
5.3	6.0.1
5.2	5.6
5.1	5.5.3
5.0	5.5.1
4.3, 4.4	4.6
4.1, 4.2	4.1

Viz Engine	NDI SDK
4.0	3.8
3.14.3-3.14.5	4.1
3.14.1, 3.14.2	3.8

## 5.12 Dual Channel Mode

This section details how to configure the Dual Channel platform of Viz Artist/Viz Engine.

Dual Channel is a video version with, typically, **two program** outputs (fill and key on two channels). To support two program outputs, this option requires two graphics cards. Once installed and configured, open the two Viz Engine consoles and add commands as required, or use an external application (for example, Viz Trio or Viz Pilot) to control the Viz Engine.

### 5.12.1 To Configure Dual Channel

1. Install Viz Engine.
2. Create the necessary shortcuts according to the table.

Shortcut Name	Shortcut Target Parameters
Viz Artist Channel 1	<code>-u1 -y</code>
Viz Config Channel 1	<code>-u1 -c</code>
Viz Config Channel 2	<code>-u2 -c</code>
Viz Engine Channel 1	<code>-u1 -n</code>
Viz Engine Channel 2	<code>-u2 -n</code>

 **Note:** Viz Artist can only operate on the first Viz Engine instance.

Make sure that all shortcuts have the field **Start in:** set to your Engine installation directory. The picture shows an example for the **Viz Engine 4.2.0.39 Channel 1** shortcut.

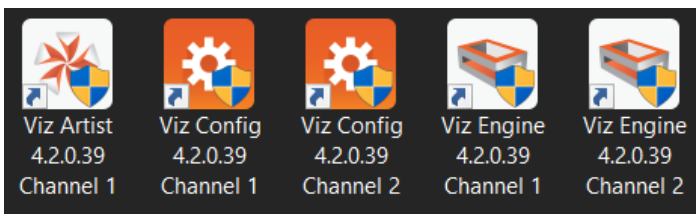
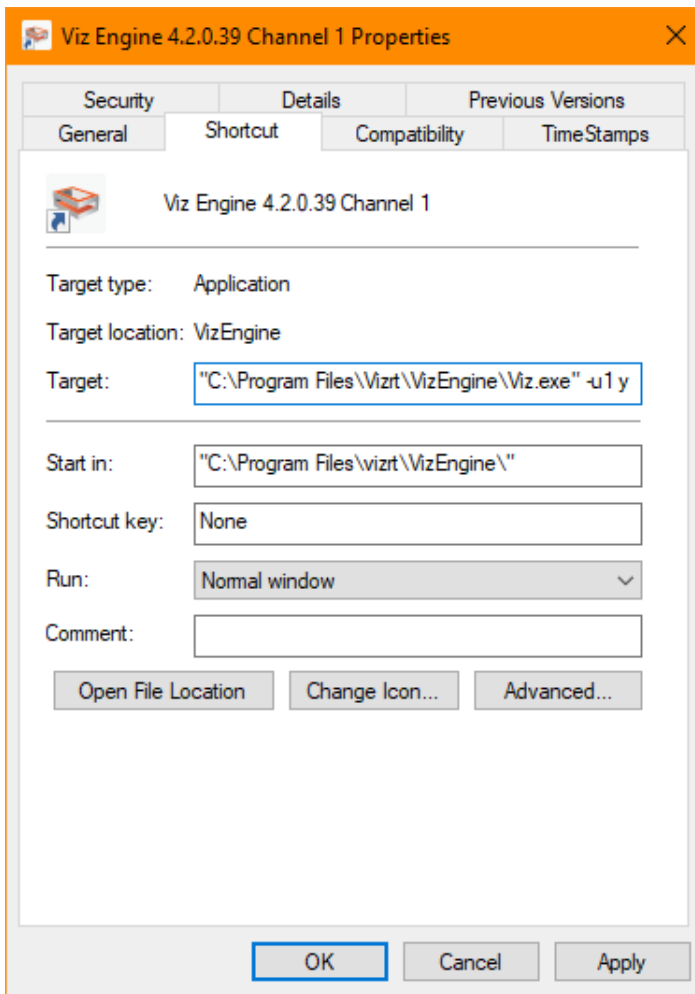

3. Open the **Viz Config Channel 1** application.
4. In **Database**, set **Auto log in** to **Yes** (active).
5. Click **Load...**



6. Select `<viz install folder>/Configuration Profiles/dualchannel-0.cfg` and click **OK**. For more information regarding the different ports and other required configuration settings see [Installed Configuration Profiles](#).
7. Configure Viz Artist/Engine as required, by setting the **Output Format**, etc. Then click **Save** and exit Viz Config.
8. Open the **Viz Config Channel 2** application and repeat the above steps to configure the second channel, using the `dualchannel-1.cfg` configuration file.

### See Also

- [Viz Trio User Guide](#)
- [Viz Pilot User Guide](#)
- [Installed Configuration Profiles](#)



## 5.13 Trio Box CG Mode

This section details how to configure the Trio Box CG (Character Generator) platform of Viz Artist/Engine.

Trio Box CG mode is a video version with, typically, **one program** and **one preview** output (fill and key on two channels). To support program and preview output, this option requires two graphics cards.

Once installed and configured, use Viz Trio to control the Viz Engines.

### 5.13.1 To Configure Trio Box CG

1. Install Viz Engine.
2. Create the necessary shortcuts similar to the examples in the table.

Shortcut Name	Shortcut Target Parameters
Viz Artist Control	<code>-u1 -y -M</code>
Viz Config Control	<code>-u1 -c -M</code>
Viz Config Program	<code>-u2 -c</code>
Viz Engine Control	<code>-u1 -n -M</code>
Viz Engine Program	<code>-u2 -n</code>

 **Note:** Viz Artist can only operate on the first Viz Engine instance.

Make sure that all shortcuts have the field **Start in:** set to your Engine installation directory. The picture shows an example for the **Viz Engine Control** shortcut.

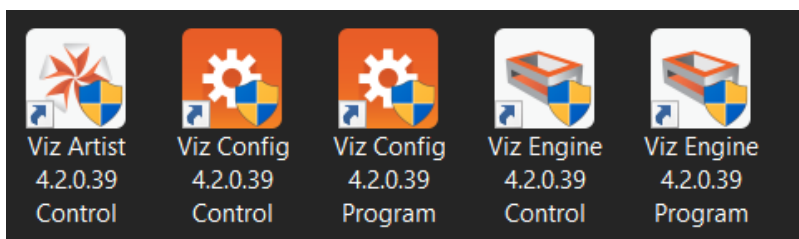
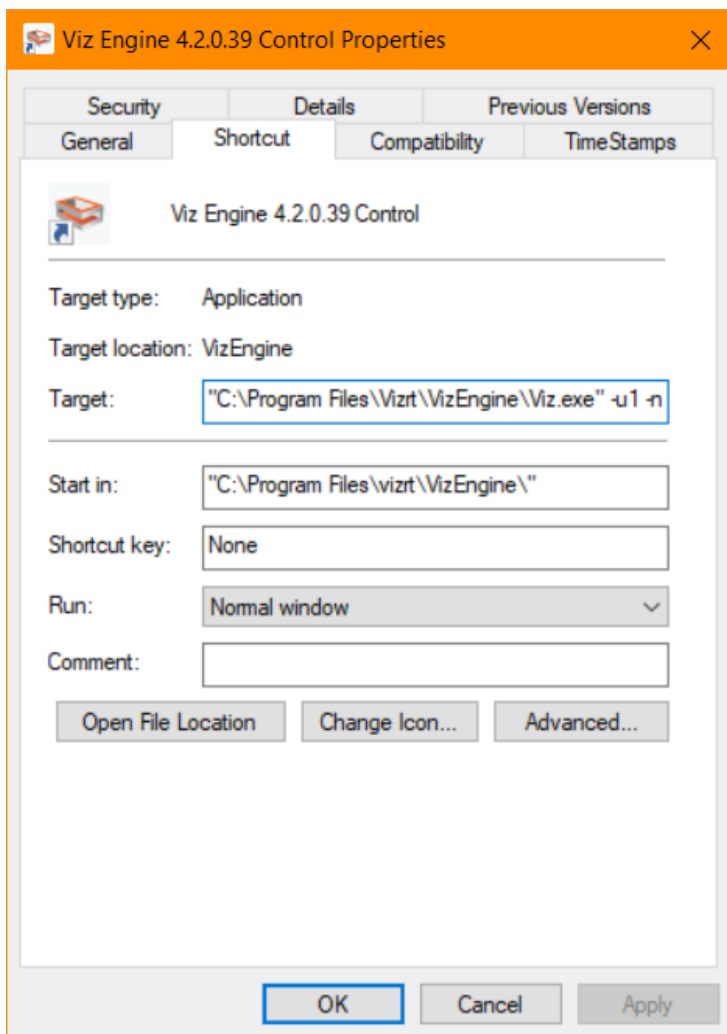

3. Open the **Viz Config Control** application.
4. In **Database**, set **Auto log in** to **Yes** (active).
5. Click **Load...**



6. Select `<viz install folder>/Configuration Profiles/trioonebox-0.cfg` and click **OK**.
7. Configure Viz Artist/Engine as required, by setting the **Output Format**, etc. Then click **Save** and exit Viz Config.
8. Open the **Viz Config Program** application and repeat the above steps to configure the second channel, using the `trioonebox-1.cfg` configuration file.

 **Information:** The preview channel needs to have a DVI out license to host the preview window.

---

## 5.14 Dolby E Support

Viz Engine is certified by Dolby for decoding Dolby E streams from the inputs into the Viz Engine, and encoding the first eight audio channels back to Dolby E on the output.

This section contains the following topics:

- [Dolby E Features](#)
  - [Dolby E License](#)
- [Dolby E Configuration](#)
  - [To Enable Dolby E Functionality](#)
  - [To Set Audio in Channels as Dolby E Inputs](#)
  - [To Enable Dolby E Encoding](#)

### 5.14.1 Dolby E Features

The Dolby E feature set in Viz Artist/ Engine is defined as follows:

- Dolby E is supported on Matrox Video I/O hardware only
- Dolby E is supported both as AES or embedded audio on the input and output side
- Decoding of one Dolby E stream (minimum eight/maximum 16 Dolby E channels) on all inputs.

 **Note:** The Dolby E stream (encoded in a stereo pair) must be on the first two AES or embedded audio channels

- Encoding of one Dolby E stream (minimum eight/maximum 16 Dolby E channels) on the fill output.

 **Note:** The Dolby E signal is encoded on the first two AES or embedded audio channels on the output.

- All audio channels from the Viz timeline can be mixed, as usual, with the decoded Dolby E signal from the inputs, and is output together with the input audio as Dolby E.
- Dolby E encoding and decoding can be configured independently. It is possible to input PCM audio and output Dolby E or vice versa.
- You can also have PCM audio on one or more inputs and Dolby E audio on different input and mix them together.
- Dolby E decoding from clip channels is **not** supported.

### Dolby E License

Each Dolby E stream processed in the system requires a license and a physical Dolby-E dongle.

For example, if there are two input signals with Dolby E and the output is to deliver Dolby E as well, two decoder and one encoder licenses are required. The Dolby E licenses are software licenses which reside on a software dongle and can hold multiple licenses for one system.

## 5.14.2 Dolby E Configuration

This section details the setup required in the Viz Config file and GUI.

### To Enable Dolby E Functionality

The Dolby E signal can be present in the embedded audio of the video signals, or on the AES inputs of the Matrox card.

1. Open the Viz Config file.
2. Set **DolbyEEnabled** to **1**.

### To Set Audio in Channels as Dolby E Inputs

The Dolby E stream must be present in the sub-channel 0 and sub-channel 1 of the input.

1. Open the Viz Config file.
2. Configure these settings as shown:
  - ChannelDolbyEEnabled\_\_0 = 1
  - ChannelDolbyEEnabled\_\_1 = 0
  - ChannelDolbyEEnabled\_\_2 = 0
  - ChannelDolbyEEnabled\_\_3 = 0
  - ChannelDolbyEEnabled\_\_4 = 0
  - ChannelDolbyEEnabled\_\_5 = 0
  - ChannelDolbyEEnabled\_\_6 = 0
  - ChannelDolbyEEnabled\_\_7 = 0

### To Enable Dolby E Encoding

This enables the encoding of the first eight internal audio channels to a Dolby E stream which are sent to the output.

- Set **DolbyEOutput** to **1**.

 **Note:** Only live video inputs are supported.

## 5.15 EVS Video Server Control

An EVS Control Plug-in lets the Viz Engine control an EVS video server (like a tape deck over RS422). This gives Viz Engine the ability to load and control playback of EVS video server clips.

This section contains information on the following topics:

- [Setup Requirements](#)
- [RS422 and XtenDD35 Configuration](#)
- [RS422 Pin-out for the Connector Cable](#)
- [RS422 Controller Set Up Examples](#)
- [Bluestorm LP PCI Card Configuration](#)
- [ExSys EX-1303 USB to RS422 Connector Configuration](#)

### 5.15.1 Setup Requirements

- The computer which runs the Viz Engine must be equipped with an RS422 controller that maps the controller ports to the Windows COM ports.
- The RS422 port must be connected to an RS422 remote controller port of the EVS video server.
- The EVS player, controlled by the RS422 port, must be set up to use the protocol *XtenDD35* (No other protocol is currently supported).

### 5.15.2 RS422 and XtenDD35 Configuration

1. You need a RS422 controller that installs the RS422 port as a new COM port in Windows.
2. Set up the *XtenDD35* protocol on the used remote port of the EVS video server.

 **IMPORTANT!** This must be done before an attempt to connect.

3. Manually set the Windows COM port settings to:
  - 38400 baud
  - 8 bytes
  - one stop bit
  - odd parity

 **IMPORTANT!** This must be set before Viz Artist is started.

4. Usually, a special RS422 cable is required to connect the controller to the EVS video server. It is recommended to use a connector cable to connect the RS422/DB9 connector to a standard RS422 cable. The RS422 cable should work with a normal EVS video server controller.
5. Every RS422 controller has a different pin-out setting and requires a different connector cable. The table below shows which signal of the RS422 controller must be connected to which pin on the EVS side:

### 5.15.3 RS422 Pin-out for the Connector Cable

Signal type of RS422 controller	Cable pin on EVS side
RxD B+ (in)	7
TxD B+ (out)	3
TxD A- (out)	8
RxD A- (in)	2
Sig Ref / Gnd	1

### 5.15.4 RS422 Controller Set Up Examples

The connection of a RS422 controller to the EVS is always different for each controller. Here are two examples:

### 5.15.5 Bluestorm LP PCI Card Configuration

Viz Engine side (Bluestorm LP card)		EVS side	
Signal type	Pin	Pin	Signal type
TxD+	2	3	RxD+
TxD-	3	8	RxD-
RxD-	4	2	TxD-
RxD+	1	7	TxD+
Sig Ref	5	1	Sig Ref

### 5.15.6 ExSys EX-1303 USB to RS422 Connector Configuration

Viz Engine side (ExSys EX-1303)		EVS side	
Signal type	Pin	Pin	Signal type

Viz Engine side (ExSys EX-1303)		EVS side	
TxD+	2	3	RxD+
TxD-	1	8	RxD-
RxD-	4	2	TxD-
RxD+	3	7	TxD+
Sig Ref	5	1	Sig Ref



---

## 5.16 Integration With Viz One

Viz Engine can be integrated with Viz One so that video clips can be transferred, and monitored, to and from Viz One. The following sections describe how to install the Transfer and Monitor services to the Viz Engine and how to enable clip playout.

A Viz One system, which is configured to communicate with the Viz Engine, must be running during the installation and configuration of the two services. Administrator rights are required to complete the install (see [Prerequisites](#)).

This section contains information on the following topics:

- [Configure Viz Engine](#)
  - [To Configure the Viz Engine](#)
- [Install Transfer and Monitor Services on Viz Engine](#)
  - [To Install the Transfer and Monitor Services](#)
  - [To Remove the Transfer and Monitor Services](#)
- [To Configure Viz One](#)
- [Configure Local Preview of Video Files](#)

### 5.16.1 Configure Viz Engine

Viz Engine must be configured for the transfer and playing-out of video clips from Viz One.

#### To Configure the Viz Engine

1. Open **Viz Configuration**.
2. Click on **Output Format**.
3. Select the correct output format as used in Viz One.
4. Click on **Video Board**.
5. Click on **Video Input**.
6. Make sure that at least one Clip Channel is active.
7. Click **Save**.
8. Restart Viz Engine.

### 5.16.2 Install Transfer and Monitor Services on Viz Engine

The **Mediaftp** (file transfer) and **Fsmon** (file system monitor) Services are required for Viz One a Viz Engine to exchange data. Both services are part of the Viz Artist Bundle installation, but must be installed (activated) or removed (deactivated) through the Viz Configuration.

 **Note:** If these Services are not required, make them unavailable when Viz Artist is installed. The Mediaftp Service prints some feedback to the Viz Engine Console. The Fsmon Service does not.

The files for Mediaftp and Fsmon are installed into the folders:

- *C:\Program Files\Vizrt\Fsmon*
- *C:\Program Files\Vizrt\Mediaftp*

Log-files are written to the folders:

- <viz data folder>\Fsmon
- <viz data folder>\Mediaftp

## To Install the Transfer and Monitor Services

**✘ IMPORTANT!** Make sure that the Clip Data Directory is set correctly before the services are installed (see [Video Board](#)).

1. Open **Viz Config**.
2. Click on [Viz One](#).
3. In the **Days to keep log files** field, set the number of days log files are to be kept (default is seven days).

4. **Fsmon** (service only):
  - a. Enter the host name of the localhost.
  - b. Enter the host name of the Viz One Message Queue Server.

**✘ IMPORTANT!** The localhost name must be exactly the same string that was entered in the Viz One as host name for the Viz Engine (it must be the exact same string as seen beside Host on the Servers page).

5. **MediaFTP** (service only): Set the transfer bandwidth (Kbits per second), as required.

**⚠ Note:** Mediaftp is installed with the `-a` flag. This assumes that the default Viz One user/password combination is: vtrsync/vtrsync. Mediaftp installs, but does not work, if the user/password combination is different (see **Adding a Viz Engine** in the Viz One Administrators Guide).

- Click on **Install** for each required Service.

**Note:** Any currently installed Services must be removed before a new Service can be installed.

## To Remove the Transfer and Monitor Services

**Note:** When a Service is removed, the Service is made **inactive**. The Service is still available, and if required again, click **Install** to make **active**.

- Open **Viz Config**.
- Click on **Viz One**.
- Click on **Uninstall** for each required Service.

### 5.16.3 To Configure Viz One

Viz Engines are configured a video server with local storage on Viz One side. For detailed information, please refer to the Viz One documentation. Before adding any Viz Engine to Viz One, make sure that FSMon and MediaFTP are running on Viz Engine.

- Login to Viz One Studio.
- Switch to **Administration**.
- Click on **VideoServers**.
  - Choose **Add - VizEngine**.

The screenshot shows the 'Add' form for a new video server. At the top, there are 'Add' and 'Edit' buttons. Below them, a summary shows 'Total: 48', 'Active: 21', and 'Error: 27'. A dropdown menu is labeled 'Select video server:'. The form contains two main input fields: 'Handle: vizengine-47' and 'Host: [ ]', where the 'Host' field is highlighted with an orange border. To the right of the 'Host' field are two buttons: 'Do Not Save' and 'Save'. Below the form is a table with the following columns: 'Server Handle', 'Server Status', 'Server Host', and 'Access Methods'. At the bottom of the interface, there is a section for storage configuration with columns: 'Storage Handle', 'Size', 'Usage', and 'Storage'.

- Enter the Viz Engine host name. Be aware that this is case sensitive.
- Note the storage ID.
- Click on **Servers**
  - Verify the Credentials for the FTP/ARDFTP access are correct.

Once configured correctly, Viz Engine must show up as **Active** in the Servers Dashboard.

### 5.16.4 Configure Local Preview of Video Files

The VML player is recommended for previewing proxy clips from Viz One.

For more information about using the VML player, please see [VML Clip Player](#).

## 5.17 Matrox Stream

- [Matrox License](#)
- [Example Matrox License Configuration](#)
- [Output Mode](#)
- [Configuring a Stream](#)
- [Example Sending MPEG-TS over RTP and Receiving with Viz Engine on localhost](#)
- [Example Receiving MPEG-TS over UDP on localhost](#)
- [Example Receiving SRT on localhost](#)
- [Example Receiving RTSP on localhost](#)
- [Example Receiving RTMP on localhost](#)
- [More Advanced Example Using ffmpeg](#)
- [Receiving Different Input Types](#)
- [Limitations](#)
- [Known Issues and Troubleshooting](#)

Viz Engine can send MPEG-TS over RTP and receive MPEG-TS over RTP/UDP, SRT, RTSP, RTMP streams by using DSX.Core or any Matrox board that has an RTP / RTP2 / STMP upgrade.

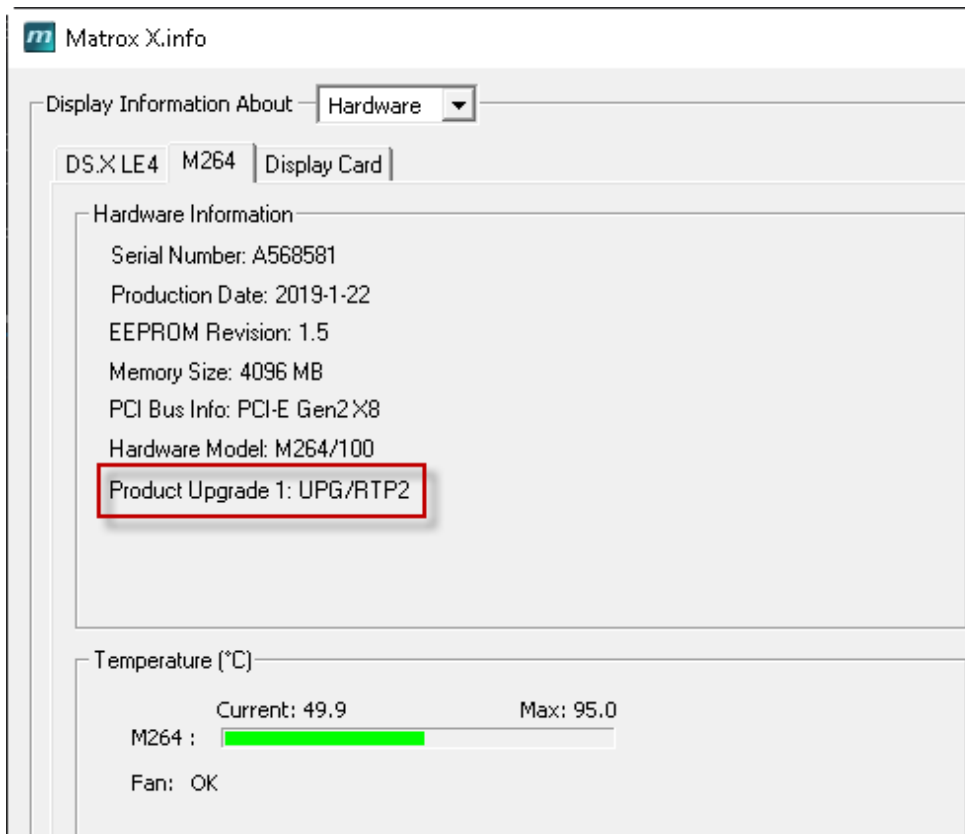

The screenshot displays the Matrox X.info web interface. At the top, there is a logo and the text 'Matrox X.info'. Below this, a navigation bar includes 'Display Information About' with a dropdown menu set to 'Hardware'. Underneath, there are tabs for 'DSX LE4', 'M264', and 'Display Card'. The main content area is titled 'Hardware Information' and lists the following details:

- Serial Number: A568581
- Production Date: 2019-1-22
- EEPROM Revision: 1.5
- Memory Size: 4096 MB
- PCI Bus Info: PCI-E Gen2x8
- Hardware Model: M264/100
- Product Upgrade 1: UPG/RTP2 (highlighted with a red box)

Below the hardware information, there is a 'Temperature (°C)' section. It shows 'Current: 49.9' and 'Max: 95.0'. A progress bar for 'M264' is shown with a green bar indicating the current temperature level. Below the temperature section, it says 'Fan: OK'.

**✘ Important:** MPEG-TS over RTP/UDP, SRT, RTSP, RTMP streaming require a Mezzanine IP license. Progressive formats are supported for output only. However, both progressive and interlaced formats are supported for input.

Features	Input	Output
Progressive	✓	✓
Interlaced	✓	✘
MPEG-TS over RTP	✓	✓
MPEG-TS over UDP	✓	✘
RTSP	✓	✘
RTMP	✓	✘
SRT	✓	✘

**⚠ Note:** Only H.264 video and AAC audio are supported. Moreover, only audio with two channels is supported. If a different audio characteristic is detected in the stream, the audio is ignored and only video is displayed.

**⚠ Note:** Since only broadcast resolution is supported and there is no framerate conversion between input and output, input and output framerates must match.

### 5.17.1 Matrox License

An RTP / RTP2 / STMP Matrox license is required in order to be able to receive any kind of stream. Which license is required depends on your existing license.

**✘ Important:** The main board, the first one appearing in *Matrox.Devices* in the Viz Engine configuration file, must have decoding capabilities. A board has decoding capabilities if it is /500 or /550, or if it has any of the following upgrades: U50, U55 or STMP.

In order to receive a stream, one of the following streaming licenses is also required for the board:

- **RTP:** Lets you receive any kind of stream except RTMP and MPEG-TS, since it lacks a demuxer.
- **RTP2:** Lets you receive any kind of stream except MPEG-TS, since it lacks a demuxer.
- **STMP:** Lets you receive any kind of stream.

**⚠ Note:** To be able to receive a stream, the license can be installed in a secondary board, it does not need to be installed in the main board.

Boards with decoding capabilities also support muxing and demuxing. For example, if a board has decoding capabilities (if it's /500, has U50 upgrade, etc.) and has an RTP license, the board is also able to receive MPEG-TS.

Boards with STMP do not need to have any other upgrades to be able to receive and decode streams; this license is usually used with /100 boards and when clip playback is not needed.

To summarize:

- **RTP / RTP2:** Are only for receiving and do not provide decoding. Additional upgrades are therefore needed, usually in the form of U50 or U55.
- **STMP:** Offers everything and is therefore usually paired with a /100 board.

There are exception to the above rules:

- **DSX.Core:** By default supports any kind of stream **except RTMP**. However, to support decoding, the license should be at least /500.
- **M264:** By default supports **only video** decoding. However, to support streaming, either of the following receiving licenses must be added: RTP / RTP2.

### 5.17.2 Example Matrox License Configuration

For a machine that has the following boards:

*DSX.LE4L/8/100F with UPG/100/U55*

*M264/100 with UPG/RTP2*

- Choosing the DSX.LE4 as main board and the M264 as secondary board, the machine can:
  - Use the following input types: SDI, MPEG-TS over RTP/UDP, SRT, RTSP, RTMP, NDI, Clip.
  - Have SDI as output.
  - Use H.264 hardware decoding to decode the incoming streams.
- Choosing only DSX.LE4 as main board and no secondary board, the machine can:
  - Use the following input types: SDI, NDI, Clip.
  - Have SDI as output.
- Choosing only M264 as main board and no secondary board, the machine can:
  - Use the following input types: SRT, RTSP, RTMP, NDI, Clip (only uncompressed clips).
  - Audio decoding is not supported.

 **Note:** In the case of a M264 main board, the machine does **NOT** have any output since RTP requires a muxer, which is only provided in a board with /500 /550 or upgrades U50, U55 or STMP. The machine does **NOT** support audio decoding or receiving MPEG-TS over RTP/UDP for the same reason.

### 5.17.3 Output Mode

There are two different output modes: SDI or RTP. To enable output to SDI, a Matrox board supporting SDI is needed and must be chosen in the configuration file: `Matrox.Devices = A520888`.

If the SDI board does not support an RTP upgrade, another board must be installed and must be included as a secondary board: `Matrox.Devices = A520888, A520898`.

If the main board, the first one appearing in `Matrox.Devices`, has the corresponding Matrox license to support RTP, then RTP output can be enabled.

To do so, change the entry `RtpOut1.Enable` in the configuration file to `1` : **`RtpOut1.Enable = 1`**.

Specify a time server in the configuration file. It is also recommended to set an NTP time server: **`ntp_server = 131.107.13.100`**.

**Info:** SDI Out, NDI Out, RTP output can be enabled at the same time.

For additional parameters to configure bitrates, enable verbose settings in the configuration file: **`VerboseConfig = 1`**.

### 5.17.4 Configuring a Stream

A stream can now be configured using the GUI interface under Live Input:

Channel	Type
Live Channel 1	STREAM
Live Channel 2	STREAM
Live Channel 3	Inactive
Live Channel 4	Inactive
Live Channel 5	Inactive
Live Channel 6	Inactive
Live Channel 7	Inactive
Live Channel 8	Inactive
Live Channel 9	Inactive
Live Channel 10	Inactive
Live Channel 11	Inactive
Live Channel 12	Inactive
Live Channel 13	Inactive
Live Channel 14	Inactive
Live Channel 15	Inactive
Live Channel 16	Inactive
Live Channel 17	Inactive
Live Channel 18	Inactive
Live Channel 19	Inactive
Live Channel 20	Inactive
Live Channel 21	Inactive
Live Channel 22	Inactive
Live Channel 23	Inactive
Live Channel 24	Inactive
Live Channel 25	Inactive
Live Channel 26	Inactive
Live Channel 27	Inactive
Live Channel 28	Inactive
Live Channel 29	Inactive
Live Channel 30	Inactive
Live Channel 31	Inactive
Live Channel 32	Inactive

Configuration Panel (Right):

- Video System: Auto
- Audio Settings:
  - Enable Audio:
- Stream Settings:
  - Url: `rtsp://localhost:8554/mystream`
  - Nic Address: `192.168.1.42`
- RTSP And RTMP Settings:
  - Source Udp Port: 0
- SRT Settings:
  - Connection Mode: LISTENER
  - Remote Url: `0.0.0.0`
  - Passphrase:
  - Seconds To Wait For Connection: 10
  - Milliseconds Of Latency: 120
- Access Unit Aligned Input:
- Disable AV Sync:
- Use Software Decoding:

The only thing that differentiates different type of streams are their URLs:

```
rtsp://localhost:22404
udp://localhost:22200?pkt_size=1316
srt://localhost:2345
rtsp://localhost:8554/mystream
rtmp://localhost:30000/live/1
```

The best way to test the functionality of a stream is by using ffmpeg. ffmpeg supports the sending of simple pattern that allows us to do basic sanity test.

**Note:** Even if a stream is being sent on localhost it is advisable to use one of the NIC as IP since otherwise it could cause problems. This issue is only known to happen to **RTP** stream.

### 5.17.5 Example Sending MPEG-TS over RTP and Receiving with Viz Engine on localhost

The following command can be used to simulate a source:

```
ffmpeg.exe -f lavfi -re -i smptehdbars=s=1280x720:r=60[out0] -c:v libx264 -profile:v high422 -pix_fmt yuv422p -x264-params "nal-hrd=cbr" -b:v 2M -minrate 2M -maxrate 2M -bufsize 2M -f rtp_mpegts -bsf:v h264_mp4toannexb "rtp://10.251.2.32:22404"
```

Viz Engine can then be configured with:

```
live_type1 = STREAM
live_system1 = 720P_6000_SMPTE296
LiveIn1.Url = rtp://10.251.2.32:22404
LiveIn1.NICAddress = 10.251.2.32
```

In this case, since we are sending to localhost, NIC address can be any of the installed network adapter IP. As mentioned previously, this configuration can be done via GUI.

### 5.17.6 Example Receiving MPEG-TS over UDP on localhost

The following command can be used to simulate a source:

```
ffmpeg.exe -f lavfi -re -i smptehdbars=s=1280x720:r=60[out0] -c:v libx264 -profile:v high422 -pix_fmt yuv422p -x264-params "nal-hrd=cbr" -b:v 2M -minrate 2M -maxrate 2M -bufsize 2M -f mpegts -bsf:v h264_mp4toannexb "udp://10.251.2.32:22404?pkt_size=1316"
```

Viz Engine can then be configured with:

```
live_type1 = STREAM
live_system1 = 720P_6000_SMPTE296
LiveIn1.Url = udp://10.251.2.32:22404
LiveIn1.NICAddress = 10.251.2.32
```

In this case, since we are sending to localhost, NIC address can be any of the installed network adapter IP. As mentioned previously, this configuration can be done via GUI.



### 5.17.7 Example Receiving SRT on localhost

For this **srt-live-transmit** is needed to wrap a UDP stream. First, send the UDP stream as described in the example above and then run the following:

```
srt-live-transmit "udp://10.251.2.32:22200?pkt_size=1316" srt://10.251.2.32:2345
```

Viz Engine can then be configured with:

```
live_type1 = STREAM
live_system1 = 720P_6000_SMPTE296
LiveIn1.Url = srt://10.251.2.32:2345
LiveIn1.NICAddress = 10.251.2.32
```

In this case, since we are sending to localhost, NIC address can be any of the installed network adapter IP. As mentioned previously, this configuration can be done via GUI.

### 5.17.8 Example Receiving RTSP on localhost

For this an RTSP server is needed. **rtsp-simple-server** is probably easiest way to get an RTSP server. After running the server run the following:

```
ffmpeg.exe -f lavfi -re -stream_loop -1 -i smptehdbars=s=1280x720:r=60[out0] -c:v
libx264 -profile:v high422 -pix_fmt yuv422p -x264-params "nal-hrd=cbr" -b:v 2M
-maxrate 2M -minrate 2M -bufsize 2M -f rtsp rtsp://10.251.2.32:8554/mystream
-rtsp_transport tcp
```

The URL and port depend on how nginx has been configured.

Viz Engine can then be configured with:

```
live_type1 = STREAM
live_system1 = 720P_6000_SMPTE296
LiveIn1.Url = srt://10.251.2.32:2345
LiveIn1.NICAddress = 10.251.2.32
LiveIn1.SrcUdpPort = 22200
```

In this case, since we are sending to localhost, NIC address can be any of the installed network adapter IP. As mentioned previously, this configuration can be done via GUI.

For receiving multiple RTSP stream the configuration SrcUdpPort must be different for each of them. This port number should also be separated by 4. In this example, the next live would be, LiveIn2.SrcUdpPort = 22204.

### 5.17.9 Example Receiving RTMP on localhost

For this an RTMP sever is needed. **nginx** is probably easiest way to get an RTMP server. After running the server run the following:

```
ffmpeg.exe -f lavfi -re -stream_loop -1 -i smptehdbars=s=1280x720:r=60[out0] -c:v
libx264 -profile:v high422 -pix_fmt yuv422p -x264-params "nal-hrd=cbr" -b:v 2M
-maxrate 2M -minrate 2M -bufsize 2M -f flv rtmp://10.251.2.32:30000/live/1
```

The URL and port depend on how nginx has been configured. Viz Engine can then be configured with:

```
live_type1 = STREAM
live_system1 = 720P_6000_SMPTE296
LiveIn1.Url = rtmp://10.251.2.32:30000/live/1
LiveIn1.NICAddress = 10.251.2.32
```

In this case, since we are sending to localhost, NIC address can be any of the installed network adapter IP. As mentioned previously, this configuration can be done via GUI.

For receiving multiple RTSP stream the configuration SrcUdpPort must be different for each of them. This port number should also be separated by 4. In this example, the next live would be, LiveIn2.SrcUdpPort = 22204.

### 5.17.10 More Advanced Example Using ffmpeg

It is possible to send clip content using ffmpeg and receive this on the Viz Engine. The clip must be first transcoded to a format that is supported by Viz Engine. This can be done in the following way:

```
ffmpeg.exe -i "clip_input.mp4" -filter:v "fps=fps=60,scale=1280:720,setdar=16/9"-
minrate 2M -maxrate 2M -bufsize 2M -vcodec libx264 -preset slow -ac 2 -ab 320k
-acodec aac -strict -2 -t 00:05:00 "clip_output.mp4"
```

The above command generates a clip that Viz Engine can support. It also makes sure that the audio is two channels and has a constant bit rate. The generated clip can then be send using the same commands as described in the previous sections.

It is also possible to use CUDA with ffmpeg to reduce the CPU usage in case testing multiple sources is needed:

```
ffmpeg -vsync 0 -c:v h264_cuvid -re -stream_loop -1 -i clip_output.mp4 -c:v
h264_nvenc -profile:v high422 -pix_fmt yuv422p -x264-params "nal-hrd=cbr" -b:a 320k
-acodec aac -strict -2 -b:v 2M -maxrate 2M -minrate 2M -bufsize 2M -f rtsp rtsp://
10.251.2.32:8554/mystream -rtsp_transport tcp
```

When sending it is advice to force the audio bit rate to constant even if the clip itself is already.

### 5.17.11 Receiving Different Input Types

It is possible to combine different input types in the same scene. The possible input types are: SDI / IP 2110, MPEG-TS over RTP/UDP, SRT, RTSP, RTMP, NDI, Clip.

### 5.17.12 Limitations

There are a lot of factors that must be taken into account to know how many streams can be received into the engine. However the following hard limit is good to have in mind. The engine **might** be able to receive up to 16x1080p60 streams. To achieve this the Engine/system must have the following minimum requirements:

- P6000 or superior.
- M264S2 or superior.
- Network must be free from congestion.
- Stream must be 4:2:0 8-bit Long GOP.
- The scene must be simple.

Receiving 16x1080p60 is the **absolute upper limit** and use most of the system resources. There is **no guarantee** that this can be achieved since there are too many variables in place.

### 5.17.13 Known Issues and Troubleshooting

- Artifacts: This is usually due to the characteristics of the stream (decoding parameters such as GOP size, bandwidth size, buffer size, etc.). The best way to know if the stream or the network is the issue, is to use **ffplay** and try to receive the stream with it. **ffplay** usually throws a lot of errors and it also shows the stream with artifacts. If this is the case we know the issue is in the source.
- Can not receive stream: Try to receive the stream first with ffplay.

## 5.18 VML Clip Player

VML Clip Player is a direct replacement for DirectShow Clip Player and an alternative to Matrox Clip Player. The main goal of VML Clip Player is to be able to play non-broadcast resolution while offering similar functionality and behavior to Matrox Clip Player.

In Matrox workflow, the user can choose the **preferred clip player**, between VML Clip Player and Matrox Clip Player via the following configuration (*VerboseConfig* must be set to `1`):

```
Default clip player to be used for this channel. 0=Matrox 1=VML
ClipIn1.Player: Default=0 Min=0 Max=1
ClipIn1.Player = 0
```

The default preferred clip player in Matrox workflow is Matrox Clip Player. It is also possible to change the preferred clip player during run-time via the following command:









```
MAIN*CONFIGURATION*CHANNELS*CLIPIN_0*PLAYER SET VML
MAIN*CONFIGURATION*CHANNELS*CLIPIN_0*PLAYER SET MATROX
```

### 5.18.1 Feature Comparison between Clip Players

Not all functionalities are available for VML. The following is a feature comparison between the three different supported clip players:

Functionality	VML	Matrox	DirectShow (Viz 4.x and earlier)
Basic Functions (Play, Pause, Stop, Load, Scrub, Continue, Flush, Autorun)	✓	✓	✓
In and out setting and getting	✓	✓	✓
Loop playback	✓	✓	✓
3-point loop / 4-point loop	✓	✓	✗
Upscale luma	✗	✓	✗
Repeat field	✓	✓	✗
Reverse field	✓	✓	✗

Functionality	VML	Matrox	DirectShow (Viz 4.x and earlier)
Playback speed	✓	✓	✓
Native pending support	✓	✓	✓
Embedded alpha format	✓	✓	✓
Multiple files (alpha / fill / audio / VBI files)	✗	✓	✗
Timecode	✓	✓	✗
VBI Passthrough (to output)	✗	✓	✗
Timecode Passthrough (to output)	✗	✓	✗
CC Extraction	✗	✓	✗
Audio	✓	✓	✗
SHM key events	✓	✓	✓
Contiguous seek performance	✓	✓	✗
DVE	✗ (1)	✓	✗ (1)
Playlist management (insert, remove, replace, etc.)	✓	✓	✗
Mode on load error (pending)	✓	✓	✗
V210 (10-bit support)	✓	✓	✗
Broadcast clip status	✓	✓	✓
Replay mode (TDIR)	✓	✓	✗
Growing files	✓	✓	✗
Dealing with display aspect ratio	✓	✓	✗



Functionality	VML	Matrox	DirectShow (Viz 4.x and earlier)
Delay audio and video			
Hardware-accelerated decoding	 (4)	 (2)	
Mixed resolution mode	 (3)	 (3)	 (3)

(1) Simulated DVE is supported.  
 (2) With an additional Matrox M264 board.  
 (3) With a slight difference in behavior documented below.  
 (4) With an NVIDIA GPU that supports NVDEC.

### 5.18.2 Mixed Resolution Mode in Matrox and VML Clip Player

Mixed resolution mode means playing clips with different resolution than the configured Viz Engine output resolution and/or the configured Viz Engine clip channel resolution. Matrox and VML clip player support the playback in mixed resolution. In Viz 4.x and earlier, Matrox clip player was already able to playback clips in mixed resolution, as long as the clips have the same *framerate family* as the output. However from Viz Engine 5.0 and later, Matrox clip player also support the playback of **selected** clips coming from smartphones with *framerate family* different than the configured Viz Engine output resolution. VML has always supported clips with *framerate family* different than the configured Viz Engine output resolution since its inception.

Even if both Matrox and VML clip players support mixed resolution, the following differences in behavior needs to be taken into account. This is referring only to mixed resolution in which the clip has the same framerate family as the configured Viz Engine output resolution.







Play er	Out put	Cha nnel	Cli p	STATUS GET AT EOF	SCRUBBING	CONCLUSION S
VML	p50	p50	p50	duration 1000 current_position 999 play_mode scrubbing EOF file_name D:/clips_reference/ 1080p50/1080p50_Video_ProRes_Encoder_ProRes[ch=2 bits=24-32]_matrox.mov frame_rate 50.00000000 markin 0 markout 1000 output_frame_rate 50.00000000	Exactly the same between Matrox and VML. 	Exactly the same between Matrox and VML. 

Player	Output	Channel	Clip	STATUS GET AT EOF	SCRUBBING	CONCLUSIONS
MATROX	p50	p50	p50	duration 1000 current_position 999 play_mode scrubbing EOF file_name D:/clips_reference/ 1080p50/1080p50_Video_ProRes_Encoder_ProRes[ch=2 bits=24-32]_matrox.mov frame_rate 50.00000000 markin 0 markout 1000 output_frame_rate 50.00000000	Exactly the same between Matrox and VML. ✓	Exactly the same between Matrox and VML. ✓
VML	p50	i25	p50	duration 1000 current_position 998 play_mode scrubbing EOF file_name D:/clips_reference/ 1080p50/1080p50_Video_ProRes_Encoder_ProRes[ch=2 bits=24-32]_matrox.mov frame_rate 50.00000000 markin 0 markout 1000 output_frame_rate 25.00000000	Matrox displayed is -1 compared to VML on scrubbing to 00:00:05:00. ✗	Matrox <b>displayed</b> last position is -1 compared to VML at scrubbing EOF. ✗
MATROX	p50	i25	p50	duration 1000 current_position 998 play_mode scrubbing EOF file_name D:/clips_reference/ 1080p50/1080p50_Video_ProRes_Encoder_ProRes[ch=2 bits=24-32]_matrox.mov frame_rate 50.00000000 markin 0 markout 1000 output_frame_rate 25.00000000	Matrox displayed is -1 compared to VML on scrubbing to 00:00:05:00. ✗	Matrox <b>displayed</b> last position is -1 compared to VML at scrubbing EOF. ✗

Player	Output	Channel	Clip	STATUS GET AT EOF	SCRUBBING	CONCLUSIONS
VML	p50	p50	i25	duration 2000 current_position 1999 play_mode scrubbing EOF file_name D:/clips_reference/ 1080i50/1080i50_Video_AVC- Intra_Encoder_AVCIntraClass100[ TimeCode] [VBI] [ch=2 bits=24-32]_avcintra.mxf frame_rate 25.00000000 markin 0 markout 2000 output_frame_rate 50.00000000	Exactly the same between Matrox and VML. ✓	Matrox <b>displayed</b> last position and Current Position is -1 compared to VML at scrubbing EOF. ✗
MATROX	p50	p50	i25	duration 2000 current_position 1998 play_mode scrubbing EOF file_name D:/clips_reference/ 1080i50/1080i50_Video_AVC- Intra_Encoder_AVCIntraClass100[ TimeCode] [VBI] [ch=2 bits=24-32]_avcintra.mxf frame_rate 25.00000000 markin 0 markout 2000 output_frame_rate 50.00000000	Exactly the same between Matrox and VML. ✓	Matrox <b>displayed</b> last position and "Current Position" is -1 compared to VML at scrubbing EOF. ✗
VML	p50	i25	p50	duration 2000 current_position 1998 play_mode scrubbing EOF file_name D:/clips_reference/ 1080i50/1080i50_Video_AVC- Intra_Encoder_AVCIntraClass100[ TimeCode] [VBI] [ch=2 bits=24-32]_avcintra.mxf frame_rate 25.00000000 markin 0 markout 2000 output_frame_rate 25.00000000	Exactly the same between Matrox and VML. ✓	Exactly the same between Matrox and VML. ✓



Player	Output	Channel	Clip	STATUS GET AT EOF	SCRUBBING	CONCLUSIONS
MATROX	p50	i25	p50	duration 2000 current_position 1998 play_mode scrubbing EOF file_name D:/clips_reference/ 1080i50/1080i50_Video_AVC- Intra_Encoder_AVCIntraClass100[ TimeCode] [VBI] [ch=2 bits=24-32]_avcintra.mxf frame_rate 25.00000000 markin 0 markout 2000 output_frame_rate 25.00000000	Exactly the same between Matrox and VML. ✓	Exactly the same between Matrox and VML. ✓
VML	i25	i25	i25	duration 1000 current_position 999 play_mode scrubbing EOF file_name D:/clips_reference/ 1080i50/1080i50_Video_AVC- Intra_Encoder_AVCIntraClass100[ TimeCode] [VBI] [ch=2 bits=24-32]_avcintra.mxf frame_rate 25.00000000 markin 0 markout 1000 output_frame_rate 25.00000000	Exactly the same between Matrox and VML. ✓	Exactly the same between Matrox and VML. ✓
MATROX	i25	i25	i25	duration 1000 current_position 999 play_mode scrubbing EOF file_name D:/clips_reference/ 1080i50/1080i50_Video_AVC- Intra_Encoder_AVCIntraClass100[ TimeCode] [VBI] [ch=2 bits=24-32]_avcintra.mxf frame_rate 25.00000000 markin 0 markout 1000 output_frame_rate 25.00000000	Exactly the same between Matrox and VML. ✓	Exactly the same between Matrox and VML. ✓

Play er	Out put	Cha nnel	Cli p	STATUS GET AT EOF	SCRUBBING	CONCLUSION S
VML	i25	p50	i25	duration 1000 current_position 999 play_mode scrubbing EOF file_name D:/clips_reference/ 1080i50/1080i50_Video_AVC- Intra_Encoder_AVCIntraClass100[ TimeCode] [VBI] [ch=2 bits=24-32]_avcintra.mxf frame_rate 25.00000000 markin 0 markout 1000 output_frame_rate 50.00000000	Exactly the same between Matrox and VML. 	Matrox <b>displayed</b> last position is -1 compared to VML at scrubbing EOF. 
MAT ROX	i25	p50	i25	duration 1000 current_position 999 play_mode scrubbing EOF file_name D:/clips_reference/ 1080i50/1080i50_Video_AVC- Intra_Encoder_AVCIntraClass100[ TimeCode] [VBI] [ch=2 bits=24-32]_avcintra.mxf frame_rate 25.00000000 markin 0 markout 1000 output_frame_rate 50.00000000	Exactly the same between Matrox and VML. 	Matrox <b>displayed</b> last position is -1 compared to VML at scrubbing EOF. 
VML	i25	i25	p50	duration 500 current_position 499 play_mode scrubbing EOF file_name D:/clips_reference/ 1080p50/1080p50_MPEG-2__Mp egIFrame422ProfileHighLevel_42 2[bitrate=300].avi frame_rate 50.00000000 markin 0 markout 500 output_frame_rate 25.00000000	Matrox displayed is -1 compared to VML on scrubbing to 00:00:05:00. 	Matrox <b>displayed</b> last position is -1 compared to VML at scrubbing EOF. 

Player	Output	Channel	Clip	STATUS GET AT EOF	SCRUBBING	CONCLUSIONS
MATROX	i25	i25	p50	duration 500 current_position 499 play_mode scrubbing EOF file_name D:/clips_reference/ 1080p50/1080p50_MPEG-2__MpegIFrame422ProfileHighLevel_422[bitrate=300].avi frame_rate 50.00000000 markin 0 markout 500 output_frame_rate 25.00000000	Matrox displayed is -1 compared to VML on scrubbing to 00:00:05:00. ❌	Matrox <b>displayed</b> last position is -1 compared to VML at scrubbing EOF. ❌
VML	i25	p50	p50	duration 500 <b>current_position 499</b> play_mode scrubbing EOF file_name D:/clips_reference/ 1080p50/1080p50_MPEG-2__MpegIFrame422ProfileHighLevel_422[bitrate=300].avi frame_rate 50.00000000 markin 0 markout 500 output_frame_rate 50.00000000	Exactly the same between Matrox and VML. ✅	Matrox Current Position (but not displayed one) is the same as duration but VML is duration -1. ❌
MATROX	i25	p50	p50	duration 500 <b>current_position 500</b> play_mode scrubbing EOF file_name D:/clips_reference/ 1080p50/1080p50_MPEG-2__MpegIFrame422ProfileHighLevel_422[bitrate=300].avi frame_rate 50.00000000 markin 0 markout 500 output_frame_rate 50.00000000	Exactly the same between Matrox and VML. ✅	Matrox Current Position (but not displayed one) is the same as duration but VML is duration -1. ❌

### 5.18.3 Non-broadcast Clip Support in Matrox and VML Clip Player

Broadcast clips are defined by their resolution (width and height), framerate, aspect ratio, scan mode and audio sample rate (48khz). The codec and format can also define a clip as broadcast clip. Examples of broadcast clips can be found in the **Media Assets > Supported Codecs > Supported Codecs for Matrox Clip Playback** section of the [Viz Artist User Guide](#).

From Viz Engine version 5.0 and later, Matrox Clip Player also supports non-broadcast clips. These clips usually comes from smartphones. All of these clips are progressive resolution with non-broadcast resolution, aspect ratio,

framerate and audio sample rate (41.1khz). The following needs to be taken into account regarding non-broadcast clip support in Matrox clip player:

- Loading a clip with different framerate than the configured Viz Engine Output framerate, converts the clip framerate to the Viz Engine Output framerate.
- DVE or Hybrid is not supported for non-broadcast clip.
- Reverse playback might not be in real time.
- Supported containers for non-broadcast clips are mostly *.mov* or *.mp4*.

#### 5.18.4 VML Clip Player as a Fallback Clip Player

When using Matrox clip player as preferred clip player and the input clip is not supported, Viz Engine automatically tries to load the clip with VML clip player. However, this is not always possible, such as in the following case:

- If the clip channel is configured as DVE or Hybrid.

When a clip channel is in fallback mode (using VML Clip Player) calling:

```
MAIN*CONFIGURATION*CHANNELS*CLIPIN_0*PLAYER GET
```

Still returns the original configuration. This is because this configuration means the **preferred clip player** to be used. If a clip is supported in Matrox clip player, then Matrox clip player is always the one used.

To know which clip player is being used at the moment the following command can be called:

```
MAIN_SCENE*VIDEO*CLIPIN*1*PLAYER GET
```

Calling this command after loading a clip tells you if a fallback has been triggered and VML is being used instead of Matrox Clip Player, if the preferred clip player is configured as Matrox Clip Player. If the preferred clip player is configured as VML, the command always returns VML.

The preferred clip player is always used first in an attempt to load a new clip. If the loads fails, then the fallback triggers. An example of a workflow if the preferred clip player is configured as Matrox Clip Player:

- User tries to load a supported clip: Matrox Clip Player is used.
- User then tries to load an unsupported clip: Matrox Clip Player is used first, Matrox Clip Player reports the clip is not supported, fallback triggers and VML Clip Player is instead used to load the clip.
- User then tries to load a supported clip: Matrox Clip Player is used first (since it is the preferred clip player) in an attempt to load the clip.

The following warning messages should appear in the console when a fallback has triggered:

*WARNING: Unable to open file with Matrox clip player (active). Attempting to open file with VML clip player.*

*WARNING: Unable to open file with Matrox clip player (pending). Attempting to open file with VML clip player.*

Depending on whether the target clip player inside Matrox Clip Player is the active or pending one.

The following message also appears after a VML Clip Player has been used to load an unsupported clip and a new clip is about to be loaded in Matrox Clip Player:

*WARNING: VML Clip Player was used to open an unsupported clip. Using Matrox Clip Player again as preferred clip player.*

The messages are there to warn the user that a clip player switch has been performed.

**Warning:** Do not use clip fallback in stage workflow since it is not fully supported. The console also displays a warning when the pending clip player is the one failing to load a clip. Basic stage workflow which do not include back to back playback or 3-4 point loop work fine. If an unsupported clip is needed, then the best course of action is to change the preferred clip player of the clip channel to *VML*:  
*ClipIn1.Player = 1.*

The following warning appears in console when the pending clip player was used to attempt load a clip but failed:

*WARNING: If this is part of a stage workflow (B2B, 3-4 point loop) clip fallback is not fully supported!!!*

### 5.18.5 Clip Player AutoFormat

From Viz Engine version 5.1, VML and Matrox Clip Player automatically decides which format to use based on the clip characteristics. The following configurations are ignored when *ClipInX.AutoFormat* is enabled:

- *clip\_bpcX*
- *ClipInX.ContainsAlpha*
- *ClipInX.UseV210*

If for any reason the old behavior is needed, disable *ClipInX.AutoFormat* (for example, *ClipInX.AutoFormat = 0*).

**Info:** The stage b2b workflow does not work with Matrox Clip Player if two clips have different formats (for example, one clip has alpha and the next one does not). If this workflow is needed with Matrox Clip Player, disable the AutoFormat setting or use VML Clip Player as the default clip player.

### 5.18.6 VML Clip Player with NVDEC

It is possible to decode a clip using NVDEC. Depending on the NVIDIA GPU in use, there are different capabilities in terms of which codec can be decoded. This is an experimental feature and can be enabled in the configuration file:

```
## Allow using NVDEC to decode clips (experimental)
** clip_use_NVDEC: Default=0
# clip_use_NVDEC = 0
```

---

## 6 Hardware Related Information

-  **Note:** As a general recommendation for all hardware types:
- Disable all power saving options in Windows or in the BIOS Settings.
  - Disable Hibernate mode.
  - Disable Secure boot for driver installations (optional).

The installation of video, audio or graphics cards is not required on a new system. However, for maintenance or upgrades, it is important to know how to install the different models.

All machines ordered from Vizrt are pre-installed and do not require any changes.

Information on how to replace a Matrox X.mio board and connect an audio-extension card can be found in the [Matrox](#) chapter.

 **IMPORTANT!** Be careful when handling cards, see [Handling and Installing Cards](#) for some advice.

---

## 6.1 Handling And Installing Cards

Static electricity from your body can damage your cards or your computer. Although you may not notice it, static electricity is generated every time you move. It's often too small to cause a spark, but it can still cause damage to sensitive electronic components or at least reduce their lifespan.

To avoid damage, please observe the following precautions:

- Do not remove cards from their anti-static bags until you're ready to install them. Before removing the cards, place the packages within easy reach of the area where you intend to perform the installation.
- You should avoid touching the chips and other components on the circuit boards. Try to handle the cards by their edges.
- Try to work in an area where the relative humidity is at least 50%.
- Do not wear wool or synthetic clothing. These fabrics tend to generate more static electricity than cotton, which is best for this kind of work.
- Turn off the power switches on your computer and its connected components.
- Once you've opened your computer, drain static electricity from your body by touching a bare metal surface on your computer chassis before you install or remove any parts of your system. If you have a grounding wrist strap, use it while handling and installing any components in your computer.

## 6.2 Graphics Boards

This section contains information on the following topics:

- [NVIDIA Driver Configuration](#)
- [Supported GPUs and Driver History](#)
- [Virtualized GPUs](#)
- [Working with Synchronous Output](#)
- [Working with Two or More GPUs](#)



## 6.2.1 NVIDIA Driver Configuration

This section contains information on the following procedures:

- [To Configure NVIDIA Driver Settings for Viz Engine, Video Mode](#)
- [Vertical Sync](#)
- [To Configure Mosaic](#)
- [NVIDIA G-SYNC Card](#)
  - [To Configure G-SYNC on One Viz Engine](#)
  - [To Configure the G-SYNC Card on Viz Engine Slaves](#)
  - [To Check the G-SYNC Status](#)
  - [Genlock \(House Sync\)](#)

To Configure NVIDIA Driver Settings for Viz Engine, Video Mode

1. Right-click the desktop and select the **NVIDIA Control Panel**.

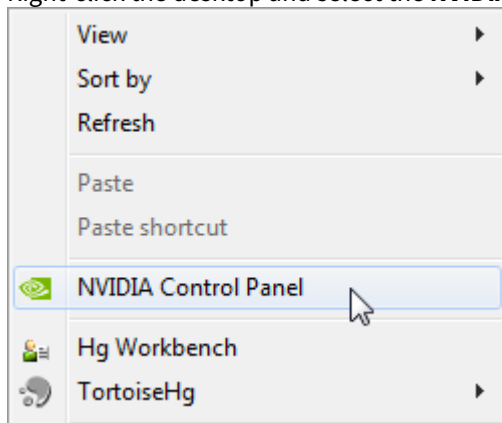

2. Click **Manage 3D settings**.

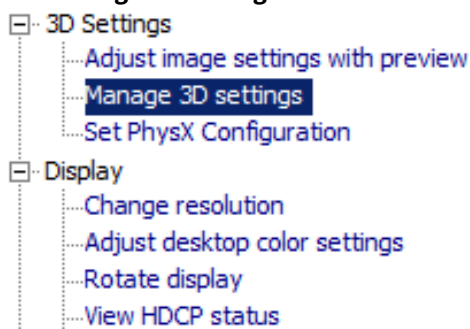

3. In **Global Settings** select the Global presets option **Base Profile**.

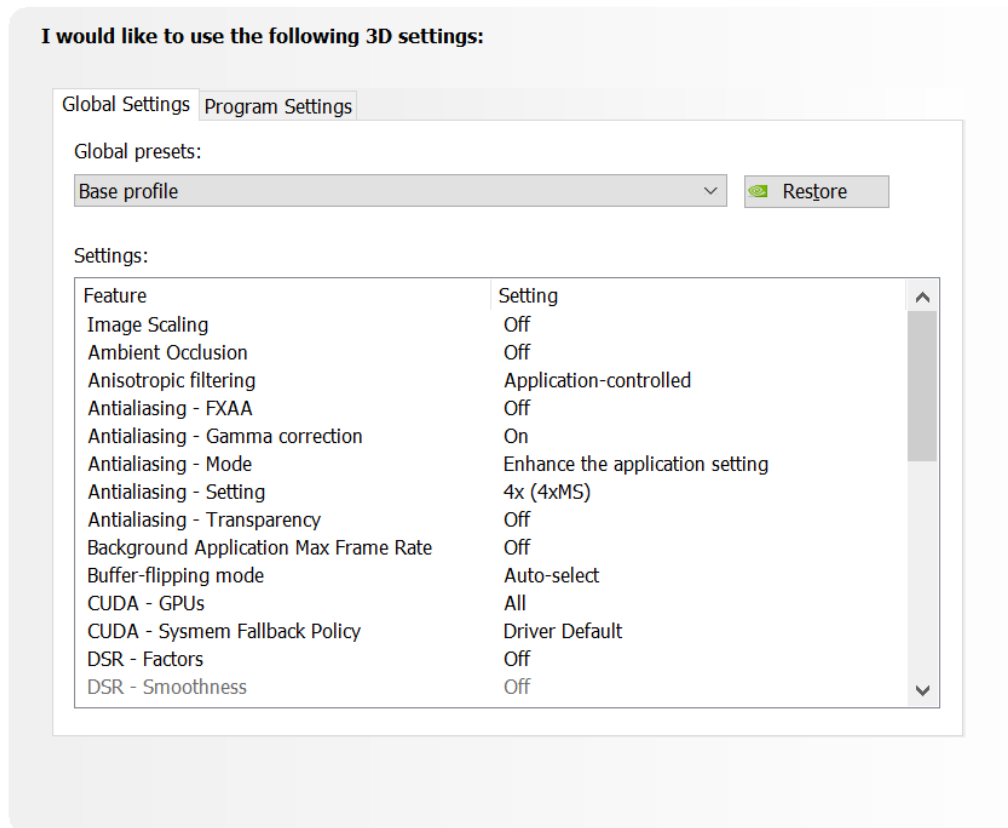

4. Set the following parameters:
  - **Ambient Occlusion:** Off .
  - **Anisotropic filtering:** Application controlled .
  - **Antialiasing-Gamma correction:** Off .
  - **Antialiasing-FXAA:** Off .
  - **Antialiasing-Mode:** Enhance the application setting .
  - **Antialiasing-Setting:** 4x (4xMS).
  - **Antialiasing-Transparency:** Off .
  - **CUDA-GPUs:** All
  - **Power management mode:** Prefer maximum performance .
  - **Vertical Sync:** Off (see **Vertical Sync** below).
5. In the **Global presets** drop-down box select **Workstation App - Dynamic Streaming**.
6. Click on **Apply**.

## Vertical Sync

Notes for Vertical Sync:

- **Use the 3D application setting:** Use for Viz Engine installations running in VGA mode (former Standard PC mode).
- **Off:** Use for Viz Engine installations where video is in use (unless used for video walls).

**Videowall:** For video wall installations, Vertical Sync must always be **On** .

### To Configure Mosaic

If setting up a Video Wall, please refer to the [Video Wall Configuration](#) chapter.

1. Right-click the desktop and select the **NVIDIA Control Panel**.
2. Click **Set up Mosaic**.
3. Tick the **Enable Mosaic** box.
4. Tick all required displays.
5. Set the **Refresh rate**.
6. Set the **Resolution (per display)**.

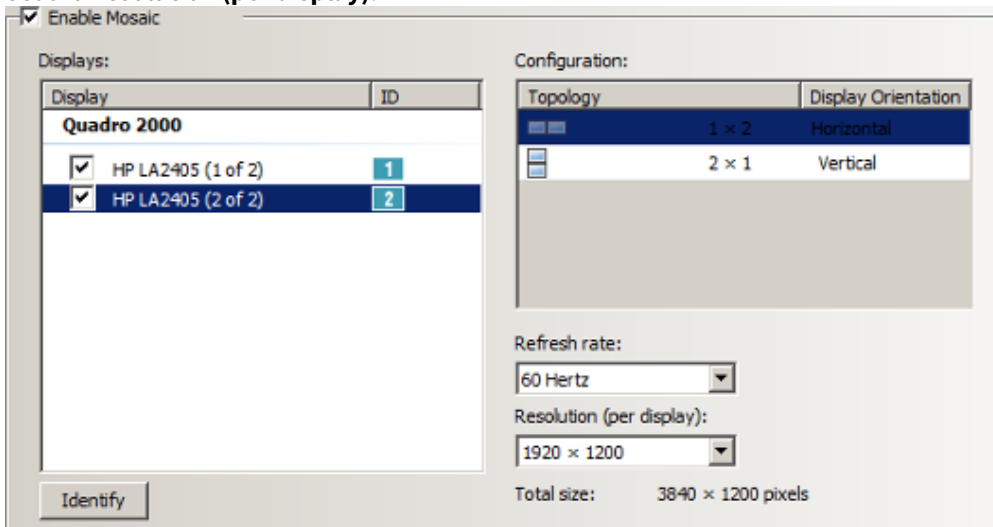

7. Click **Apply**.
8. Open Viz Config.
9. Click on **User Interface**.
10. Set **Screen Layout Mode** to **Mosaic Horizontal** or **Mosaic Vertical**.

### NVIDIA G-SYNC Card

The G-SYNC card makes sure that all screens, which make up a Video Wall, are synchronized. When there are several Viz Engines in use, one is defined as the master and all the others as slaves. Pascal GPUs and higher require a G-SYNC Gen2 version.

Make sure your G-SYNC is running on the latest firmware:

Generation	Version
Quadro Sync 2	2.02
Quadro Sync	7.01

## To Configure G-SYNC on One Viz Engine

1. On Viz Engine, go to the NVIDIA control panel.

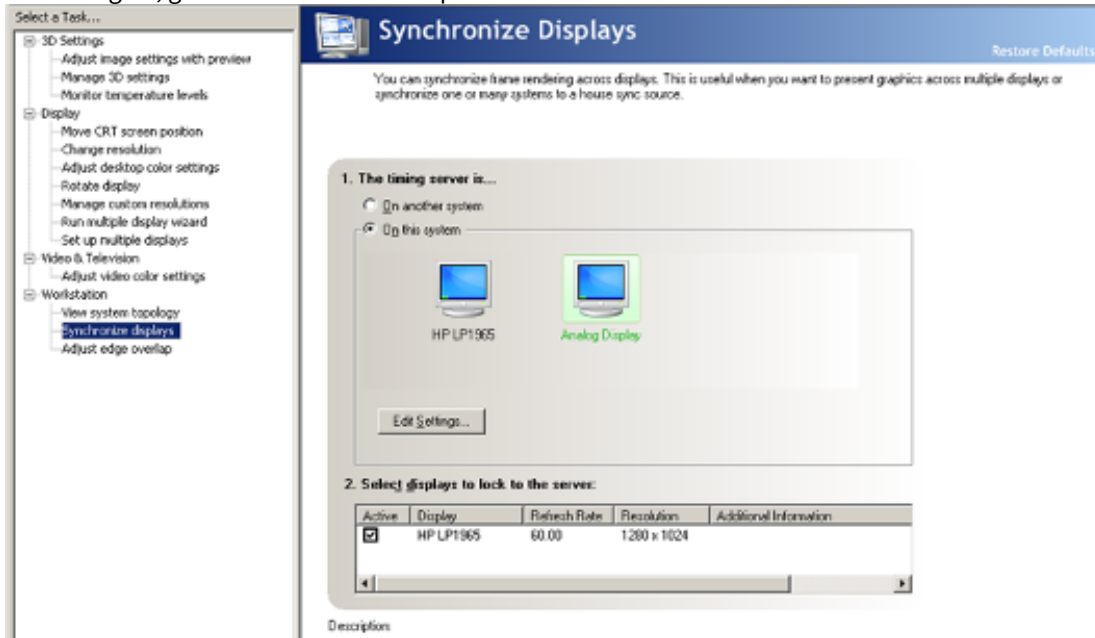

2. In **Workstation**, click **Synchronize displays**.
3. In **The timing server is...**, click **On this system**.
4. In **Select displays to lock to the server**, click each available display, in the field below, to make them active.

## To Configure the G-SYNC Card on Viz Engine Slaves

Do this procedure on each Viz Engine slave.

1. On the Viz Engine slave, open the NVIDIA control panel.

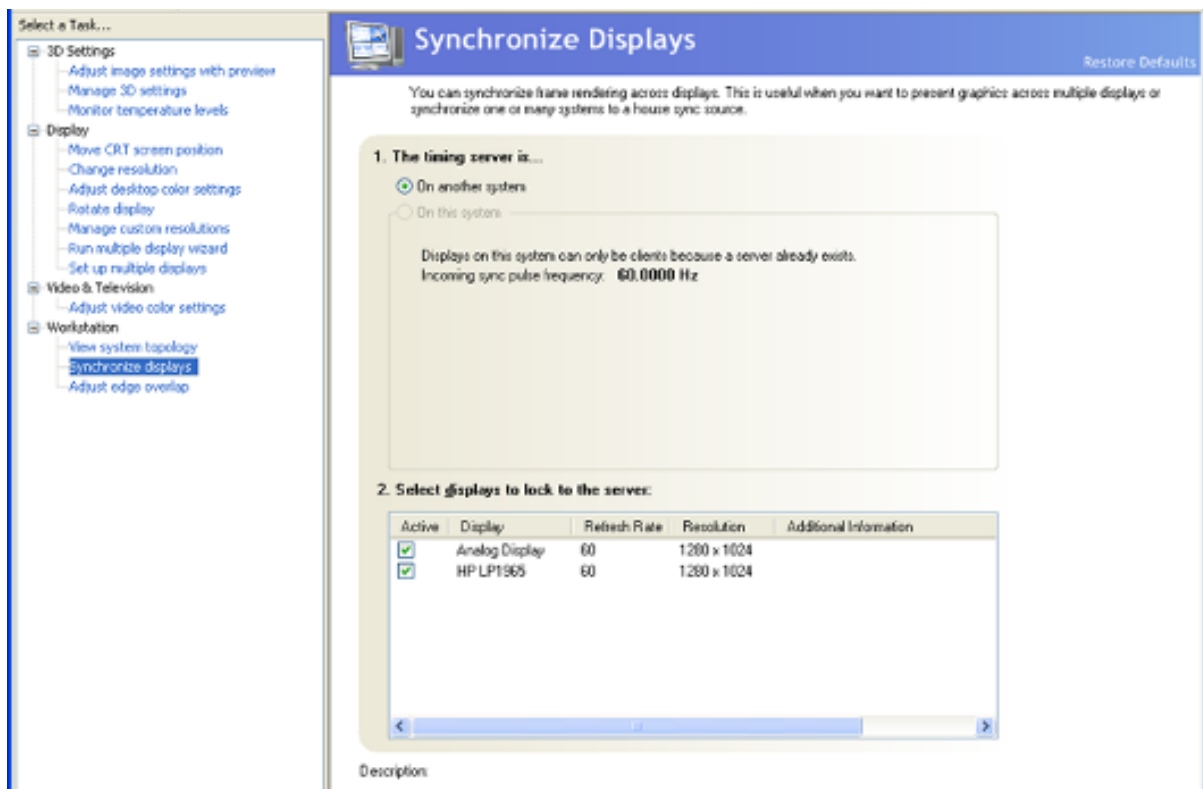

2. In **Workstation**, click **Synchronize displays**.
3. In **The timing server is...**, click **On another system**.
4. In **Select displays to lock to the server**, click each available display, in the field below, to make them active.

### To Check the G-SYNC Status

1. On each machine, in turn, open the NVIDIA control panel.
2. In **Workstation**, click **View system topology**.
3. On the slave system, make sure that **Frame lock sync pulse is present** shows in the G-SYNC status portion on the lower part of the screen.

### Genlock (House Sync)

There also the option to use a genlock (house sync) signal from the studio as an input to the G-SYNC card. In this case, once connected, check the signal in the **View system topology** screen, in **Workstation**. **House sync signal is not present** (1) means that no external genlock is connected and that the pulse is generated internally. If the external genlock is not used, this message can be ignored.

**NVIDIA Control Panel**  
File Edit Desktop Workstation Help

Back

Select a Task...

- 3D Settings
  - Adjust image settings with preview
  - Manage 3D settings
- Display
  - Change resolution
  - Adjust desktop color settings
  - Rotate display
  - View HDCP status
  - Set up digital audio
  - Set up multiple displays
- Stereoscopic 3D
  - Set up stereoscopic 3D
  - View rating for games
- Video
  - Adjust video color settings
  - Adjust video image settings
- Workstation
  - View system topology**
  - Set up Mosaic
  - Change ECC state
  - Manage GPU Utilization
  - Synchronize displays

**View System Topology**

This page shows the displays and graphics cards connected within this system.

Expand all Refresh

**Mosaic Displays**

System topology	Status	Settings
<b>Mosaic Displays</b>		
Configuration		<a href="#">3 x 1 Topology</a>
Resolution, refresh rate		7680 x 3240 pixels, 50.00 Hz
Display Sync State		Quadro Sync II Server
Timing	✓	The display is locked to the house sync signal
OS Screen Identifier		1

**Displays and Graphics Cards**

System topology	Status	Settings
<b>System</b>		
Driver version		385.41
Vertical sync	✓	<a href="#">On</a>
3D Stereo		<a href="#">Disabled</a>
<b>Quadro Sync II (server)</b>		
Framelock 0	Out	
Framelock 1	Out	
External sync signal	✓	Present (In use)
Framelock sync pulse	✓	Present
Sync settings		<a href="#">Synchronize Displays</a>
<b>Quadro P6000</b>		
DVI	Not connected	<a href="#">EDID (Monitor)</a>
DisplayPort (4)	Not connected	<a href="#">EDID (Monitor)</a> , <a href="#">Multi-Display Cloning (Disabled)</a>
DisplayPort (3)	Connected: Data General DGC175 (2 of 2)	<a href="#">EDID (Monitor)</a> , <a href="#">Multi-Display Cloning (Disabled)</a>
DisplayPort (2)	Connected: Data General DGC175 (1 of 2)	<a href="#">EDID (Monitor)</a> , <a href="#">Multi-Display Cloning (Disabled)</a>

System Information

## 6.2.2 Supported GPUs and Driver History

- [Supported NVIDIA GPUs](#)
- [Virtualized GPUs](#)
- [Driver History](#)

### Supported NVIDIA GPUs

Ada Lovelace GPUs	Ampere GPUs	Turing GPUs	Volta GPUs	Pascal GPUs	Maxwell GPUs	Kepler GPUs <sup>(1)</sup>
RTX 6000 Ada	RTX A6000	RTX 6000	GV100	Quadro P6000	Quadro M6000	Quadro K6000
RTX 5000 Ada	RTX A5500	RTX 5000		Quadro P5200	Quadro M4000	Quadro K5000
RTX 4500 Ada	RTX A5000	RTX 4000		Quadro P4200	Quadro M2000	Quadro K5200
RTX 4000 Ada SFF	RTX A4500	RTX 3000		Quadro P4000		Quadro K4000
	RTX A4000	T1000		Quadro P3200		Quadro K4200
	RTX A2000			Quadro P2200		Quadro K2000
	RTX A3000 (mobile)			Quadro P2000		Quadro K2200
	RTX A2000 (mobile)			Quadro P1000		
	RTX A1000 (mobile)					

**Orange** entries are recommended for rendering photo-realistic graphics on the Viz Engine Pipeline.

<sup>(1)</sup> Kepler GPUs require an older driver version ([473.47](#)). Supported on the Classic Render Pipeline for backward compatibility only.

## Virtualized GPUs

The following GPUs have been tested in virtualized environments, the listed driver version is the one being used. The following GPUs are currently supported (Kepler are only supported in the Classic Render Pipeline):

Model	Driver	Platform
NVIDIA L4	552.55	AWS (g6 instances, gr6 instances)
NVIDIA A10G	552.55	AWS (g5 instances)
NVIDIA A40 <sup>(2)</sup>	538.95	vSphere 7.0 and 8.0
NVIDIA RTX6000	538.95	vSphere 7.0 and 8.0
NVIDIA T4 Tensor Core	552.55	AWS (g4dn instances)
NVIDIA Tesla V100	431.79 GRID	AWS (p3 instances)
NVIDIA M60	462.96	AWS (g3s instances)

## Driver History

Viz Artist/Engine Version	Driver
5.3.1	<a href="#">553.24</a> for Ada Lovelace GPUs <a href="#">553.24</a> for Ampere, Turing, Pascal, Maxwell, Volta GPUs <sup>(1)</sup>
5.3	<a href="#">552.22</a> for Ada Lovelace GPUs <a href="#">552.22</a> for Ampere, Turing, Pascal, Maxwell, Volta GPUs <sup>(1)</sup>
5.1, 5.2	528.89 for Ada Lovelace GPUs 516.59 for Ampere, Turing, Pascal, Maxwell, Volta GPUs <sup>(1)</sup>
5.0.0, 5.01	516.59 473.47 for Kepler boards
4.4.0, 4.4.1	472.12
4.3.0, 4.3.1	462.31
4.2.0	442.19



Viz Artist/Engine Version	Driver
3.13.x, 3.14.x,4.0, 4.1	419.17
3.9.x, 3.10.0, 3.11.x, 3.12.x	385.41
3.8.3	368.86
3.8.2	361.91
3.8.1	353.82
3.8.0	347.25
3.6.4	341.21
(1) When used in combination with Unreal Engine 5.3 and higher, <a href="#">552.22</a> or higher is mandatory.	

 **Note:** There is no driver recommendation for virtual environments as they rely on the host operating system being used.

#### See Also

- [Video Wall Configuration](#)

## 6.2.3 Virtualized GPUs

Viz Engine requires a suitable GPU to operate correctly. If Viz Engine is used in a cloud environment, the correct display driver needs to be used. Cloud instances are mainly used for compute tasks, not every GPU can be used as rendering device. For example, NVIDIA Tesla GPUs are intended primarily for compute tasks, using the GPU for machine learning, AI etc. If you want to use these GPUs for other tasks, like rendering, you need to install a different driver.

There are several types of drivers available:

- **Tesla drivers / Datacenter drivers:** These drivers are optimized to be used for compute tasks like machine learning. They support technologies like OpenCL, CUDA and nvEnc.
- **Grid drivers or Gaming drivers:** Drivers for graphics tasks. Grid drivers are mainly used for professional virtual workstations whereas gaming driver are being updated more frequently and contain a lot of specify optimizations, mainly for popular game titles. Supported technologies are OpenGL, DirectX, Vulkan, CUDA and nvEnc.

A driver can run in two modes, TCC (Tesla Compute Cluster) or in WDDM mode (Windows Display Driver). **Viz Engine requires a WDDM driver.** To check in which mode your driver is running, use the `nvidia-smi` tool. This tool is located either in the NVIDIA driver directory or in the Windows System32 directory.

Call `nvidia-smi.exe -q`.

This gives you details about the driver. Check for the line **Driver Model**. If it says TCC, your driver is running in Tesla Compute Cluster mode and can not be used by Viz Engine. As an alternative, open the NVIDIA Control panel. If there is no section called **Manage 3D Settings**, your board is most likely running in TCC mode:

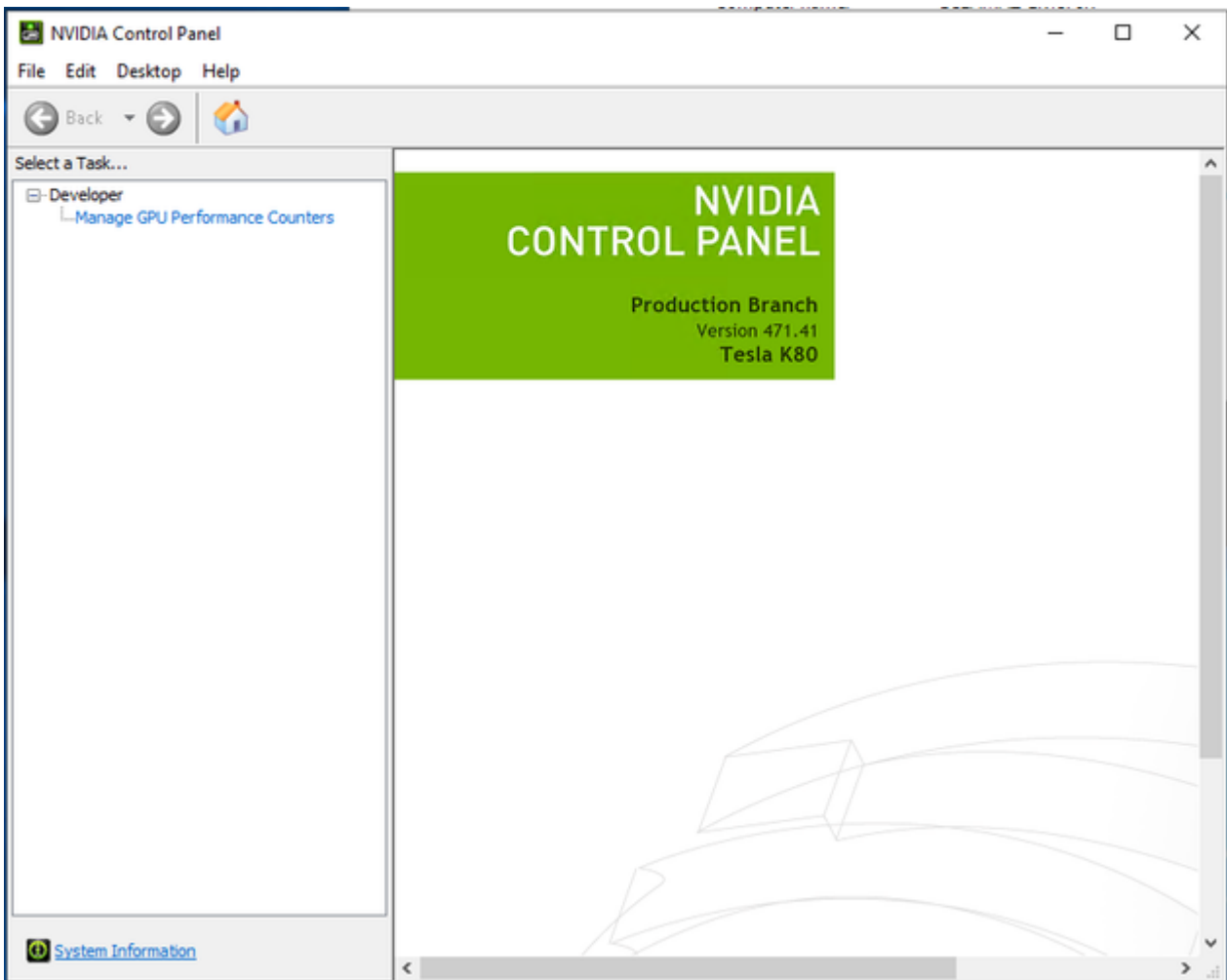

Some drivers can be changed to operate in WDDM mode. To do so:

- Call `C:\Program Files\NVIDIA Corporation\NVSMI>nvidia-smi.exe -g 0 -dm 0`.
- Set driver model to WDDM for GPU 00000000:00:1E.0.
- Reboot your system.

This attempts to change the driver mode. Not every GPU and every driver can be forced to operate in WDDM mode.

GPU	Tesla driver	GRID driver	Gaming driver
Tesla M60	✓	✓	✗
Tesla T4	✓	✓	✓
A10g	✓	✓	✓
V100	✓	✓	✗

## To Install the Correct Driver

Drivers can be downloaded either from [NVIDIA's Driver](#) section or you can install the drivers provided by the cloud provider. AWS offers customized drivers for GRID and gaming purposes, therefore it is recommended to use these drivers instead of the NVIDIA ones.

## Prerequisites

[Windows PowerShell Tools for AWS](#) are required. Please follow these steps:

1. To install, run `Install-Module -Name AWS.Tools.Installer`.
2. Create an Access key and obtain a Secret access key.
3. Save them as profile using the `Set-AWSCredential`.
4. Use this profile as the default: `Initialize-AWSDefaultConfiguration`.

## Installing a GRID Driver (AWS)

Make sure your credentials are valid and have been configured using the PowerShell tools.

Run the following command:

```
$Bucket = "ec2-windows-nvidia-drivers"
$KeyPrefix = "latest"
$LocalPath = "$home\Desktop\NVIDIA"
$c = Get-AWSCredential -ProfileName MyNewProfile
$Objects = Get-S3Object -BucketName $Bucket -KeyPrefix $KeyPrefix -Region us-east-1
-Credential $c
foreach ($Object in $Objects) {
    $LocalFileName = $Object.Key
    if ($LocalFileName -ne '' -and $Object.Size -ne 0) {
        $LocalFilePath = Join-Path $LocalPath $LocalFileName
        Copy-S3Object -BucketName $Bucket -Key $Object.Key -LocalFile $LocalFilePath
-Region us-east-1 -Credential $c
    }
}
```

The region parameters may need to be changed to match your location. Run the setup procedure as usual. Tesla M60 and other GRID GPUs might require an NVIDIA license server. Make sure the license server is valid and reachable via DNS.

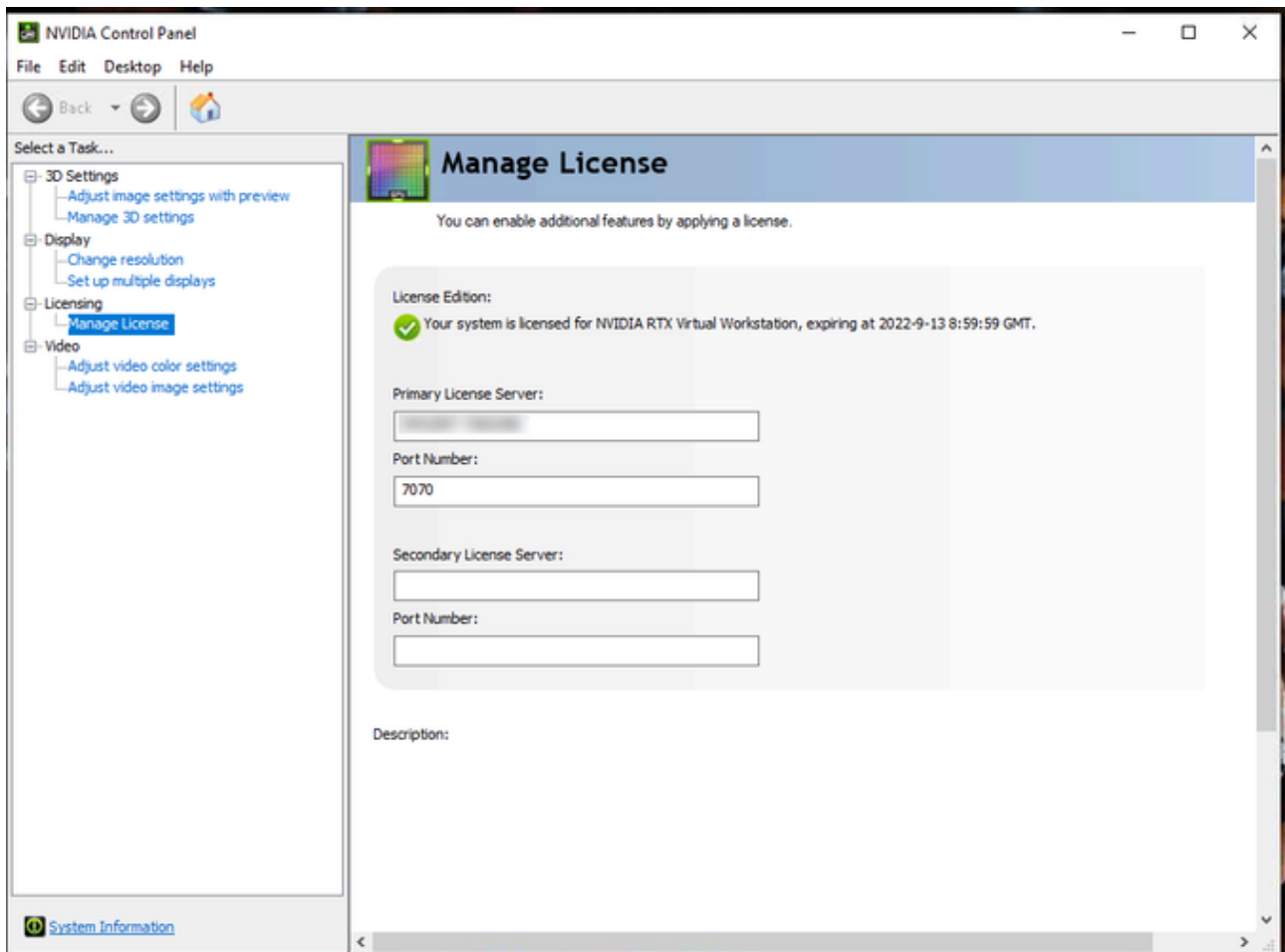

To prevent users from changing the license setting, the above entry can be hidden by changing *HKLM:* `\SOFTWARE\NVIDIA Corporation\Global\GridLicensing\NvCplDisableManageLicensePage DWord=1` in the Windows registry.

### Installing a Gaming Driver (AWS)

If your GPU has gaming drivers available, (T4, A10, V100 GPUs), they can be downloaded as described in the previous steps, however you need to change the Bucket to be *nvidia-gaming*.

To install these drivers, you need to run the following PowerShell script within your AWS installation.

```
$Bucket = "nvidia-gaming"
$KeyPrefix = "windows/latest"
$LocalPath = "$home\Desktop\NVIDIA"
$Objects = Get-S3Object -BucketName $Bucket -KeyPrefix $KeyPrefix -Region us-east-1
foreach ($Object in $Objects) {
    $LocalFileName = $Object.Key
    if ($LocalFileName -ne '' -and $Object.Size -ne 0) {
        $LocalFilePath = Join-Path $LocalPath $LocalFileName
        Copy-S3Object -BucketName $Bucket -Key $Object.Key -LocalFile $LocalFilePath
    }
}
```

```
}
```

Run the *nvidia-smi* tool to verify if your license is okay. Check for **License Status**. If the license status does not report as *licensed*, you need to run:

```
New-ItemProperty -Path "HKLM:\SOFTWARE\NVIDIA Corporation\Global" -Name  
"vGamingMarketplace" -PropertyType "DWord" -Value "2"  
Invoke-WebRequest -Uri "https://nvidia-gaming.s3.amazonaws.com/GridSwCert-Archive/  
GridSwCertWindows_2021_10_2.cert" -OutFile "$Env:PUBLIC\Documents\GridSwCert.txt"
```

This downloads a certificate file. A restart is required.

### See Also

- [Windows Accelerated Computing Instances \(external\)](#)

## 6.2.4 Working with Synchronous Output

**Information:** This is supported on the Classic Render Pipeline only!

With a dual channel setup it is easy to create two fill/key pairs for the left and right eye/camera during a stereo production. A special version of the Video Wall Distributor synchronously distributes one command to the two instances of the Viz Engine. It includes a built-in locking mechanism that makes sure both Viz Engines stay in sync, even if one of them drops a frame. This feature can be set On or Off by a simple command sent through the distributor.

This section contains information on the following topics:

- [Hardware Requirements](#)
- [Software Requirements](#)
- [Synchronous Output Configuration](#)
- [To Configure a Machine with Two Graphics Cards](#)

### Hardware Requirements

- Certified Vizrt workstation.
- Two NVIDIA Quadro (GPUs must be identical).
- Matrox video in- and output card.

### Software Requirements

- Viz Artist/Viz Engine version 3.3 or later.

### Synchronous Output Configuration

The Viz Engine installer includes an option for dual channel support. Choosing this option generates desktop icons to start the configuration and the Viz Engine for channel 1 as well as for channel 2.

**Note:** Viz Artist is only available for channel 1 as it always runs on the first GPU.

The configurations use one video input per channel and embedded audio on the channel. The table below shows the main differences in the configurations:

	Viz Engine 1	Viz Engine 2
Stereo Mode	LEFT_EYE	RIGHT_EYE
Video In A	Video1	Unused
Video In B	Unused	Video 1
Video In C+D	Unused	Unused

	Viz Engine 1	Viz Engine 2
Clip A	Clip 1	Clip 1
Clip B	Clip 2	Clip 2
Video Out A	Fill	Unused
Video Out B	Unused	Fill
Video Out C	Key	Unused
Video Out D	Unused	Key
Communication Port	6700	6800

Since this configuration puts an extra load on the Matrox card, it is important to use the available resources with care:

- In the video section of the scene, switch off all unused layers.
- Let the GPU do the color conversion.

The Matrox card itself is synced through the first instance of Viz Engine.

It is important that only **one** display is active in the NVIDIA control panel. If you span the desktop across multiple GPUs, the affinity mask has no effect and both Viz Engines render on GPU.

## To Configure a Machine with Two Graphics Cards

1. Install Viz Engine and create shortcuts for two channels using the `-u1` and `-u2` parameter.
2. Create two copies of the selected Viz Config file and place them in your Viz directory and rename one to `VIZENGINE-0.cfg` and the other `VIZENGINE-1.cfg`.
3. Load the correct output format using the configuration profiles and apply `dualchannel-0.cfg` for instance 1 and `dualchannel-1.cfg` for instance 2.
4. Start Viz Config for both instances (channel 1 and channel 2) and enter settings for the Viz Graphics Hub (see [Database](#)) and enable Auto Log-in.
  - Auto log-in is needed as dual channel Engines start without a UI.
5. Start Viz Engine for channel 1 and then Viz Engine for channel 2.
  - Channel 1 signals are available on Matrox OutA (fill) and OutC (key).
  - Channel 2 signals are available on Matrox OutB (fill) and Out D (key).

### See Also

- [Viz Command Line Options](#)
- The Camera section of the [Viz Artist User Guide](#)
- The Configuration Interface section of the [Viz Trio User Guide](#)



## 6.2.5 Working with Two or More GPUs

Multiple instances of Viz Engine can be spawned along multiple graphic cards. The assignment of the GPU to be used is done automatically if the `-u1` `-u2` parameters are used. If in addition the `-G1` , `-G2` parameters are provided, the GPU can be bound to the Viz Engine instance.

Some example use cases:

- **Two Program Outputs:** Using two instances that can run two program channels on a Dual Channel system.
- **Viz Trio Onebox Installation:** Using one instance to render a full SDI/IP Program channel on a strong GPU and a less powerful GPU to render a Viz Engine hosted by the Viz Trio client.
- **One Program Output and One Preview Output:** Running a control application with one instance for preview and one instance for program output with video. Ideal for outside broadcast environments.
- Multiple frame servers on one machine.

 **Note:** The limitations to such systems (in general and not limited to Vizrt systems alone) are memory usage, access and a lack of power redundancy. Also keep in mind that the memory usage of each machine needs to be covered by the system (for example, two P6000 with 24 GB of texture memory require a machine with at least 48 GB).

A Dual GPU setup can also be used with Viz Engine version 5.3 or later to distribute the load between third party render engines (Unreal) and Viz Engine. For more details, please see **Setting up a Multi-GPU Workflow** in the [Viz Artist User Guide](#).

### See Also

- [Working with Synchronous Output](#)

---

## 6.3 Supported Systems

-  **Note:** As a general recommendation for all hardware types:
- Disable all power saving options in Windows or in the BIOS Settings.
  - Disable Hibernate mode.
  - Disable Secure boot for driver installations (optional).

The installation of video, audio or graphics cards, is not required on a new system. However, for maintenance or upgrades, it is important to know how to install the different models.

All machines ordered from Vizrt are pre-installed and do not require any changes.

This section describes the all supported systems and their configuration supported by Viz Engine.

-  **IMPORTANT!** Any other setup than those described is not guaranteed to be supported by Vizrt and may cause problems during operation.

-  **Note:** Vizrt may make changes to specifications and product descriptions at any time, without notice.

This section contains information on the following topics:

- [Dell R7920](#)
- [HP Z4 G4](#)
- [HP Z4 G5](#)
- [HP Z4 Rack G5](#)
- [HP Z8 G4](#)
- [HP Z8 G5 Fury](#)
- [HP ZCentral 4R](#)
- [Lenovo P3 Ultra](#)
- [Lenovo P620](#)
- [Lenovo SR655 V3](#)

### 6.3.1 Dell R7920



#### Dell R7920 Rack Workstation Slots



Slot	Usage
Slot 1 - PCIe3 x8	Graphics Card only! (Single / Dual Slot)
Slot 2 - PCIe3 x8	Used if a Dual-Slot Graphics Card is installed Matrox AES Audio
Slot 3 - PCIe3 x8	Video Card (Matrox Video Board)
Slot 4 - PCIe3 x16	Expansion Cards: <ul style="list-style-type: none"> <li>• Matrox AES Audio</li> <li>• Blue Storm</li> <li>• SeaLevel</li> </ul>
Slot 5 - PCIe3 x8	Video Card (Matrox Video Board) (if two Graphics Cards are installed)
Slot 6 - PCIe3 M2 SSD	PCIe M.2 SSD
Slot 7 - PCIe3 x8	Used if a Dual-Slot Graphics Card is installed

Slot	Usage
Slot 7 – PCIe3 x8	Second Graphics Card

**i** **Info:** Only newer Matrox Boards like X.mio5, X.mio3 and DSX LE4 are supported with Dell R7920 workstations. Older videoboard are not tested by Vizrt.

## Default Hardware

- Rack 2RU
- CPU: 2x Intel Xeon Silver 4114 (2.2GHz 10-Core) or 2x Intel Xeon Silver 4210R (2.4GHz 10-Core)
- RAM: 64 GB DDR 4 (8x 8GB)
- SSD1: 512 GB S-ATA Hot Swap (Operating System)
- SSD2: 512 GB M.2 NVMe on PCIe Card in Slot 6 (Data and Clips)
- RAID Controller: Intel SATA/NVMe M.2
- Power Supply: 2x 1600 W Efficient (Dual GPU configurations require 220V Input for redundancy)

## BIOS Settings

- During Post, press **F2** to get access to the BIOS Setup.
  - Click on **System BIOS**.
  - Click on **Processor Settings**.
  - Set **Logical Processor** to **DISABLED**.
  - Press **ESC** to Exit Menu.
- Click on **SATA Settings**.
  - Set **Embedded SATA** to **RAID MODE**.
  - Press **ESC** to Exit Menu.
- Click on **NVMe Settings**.
  - Set **NVMe Mode** to **NonRAID**.
  - Press **ESC** to Exit Menu.
- Click on **Boot Settings**.
  - Check if **Boot Mode** set to **UEFI**.
  - Press **ESC** to Exit Menu.
- Click on **Integrated Devices**.
  - Set **Embedded Video Controller** to **DISABLED**.
  - Press **ESC** to Exit Menu.
- Click on **System Profile Settings**.
  - Set **System Profile** to **Performance**.
  - Press **ESC** twice, Settings are saved.
- Exit Bios.
- Press **F2** to access BIOS.
- Click on **Boot Settings**.

- Change **Boot Order** (C should be at top).
- **Save** Changes and **Exit**.

 **Info:** Certain third party vendor drivers require secure boot to be disabled to install properly.

### 6.3.2 HP Z4 G4

This section describes how to setup a HP Z4 G machine with the different cards provided by Vizrt. More details about the HP Z4 G4 can be found on HP's website: [HP Z4](#).

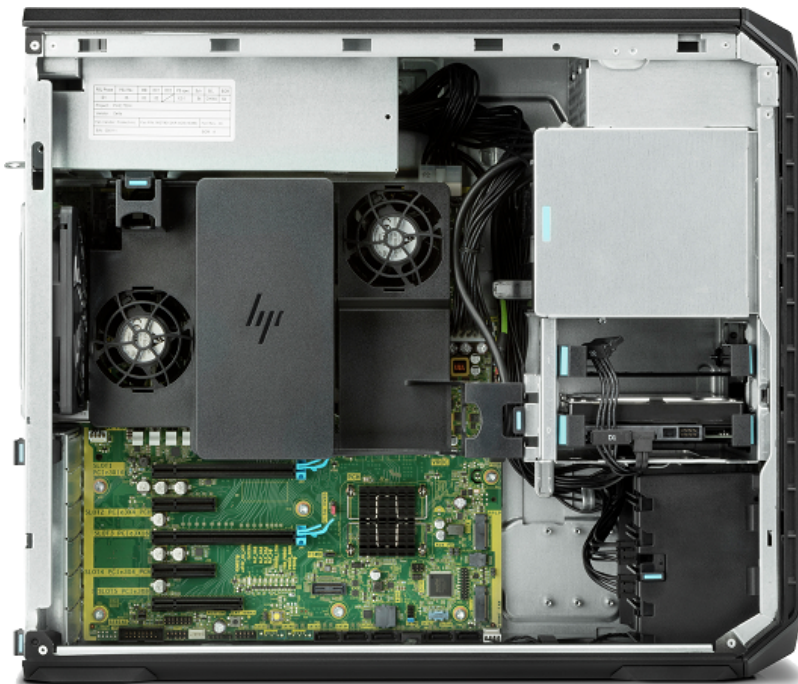

**Info:** Only newer Matrox Boards like X.mio3 and DSX LE4 are shipped with Z4 G4 workstations. Older videoboard are not tested by Vizrt.

### PCI Configuration

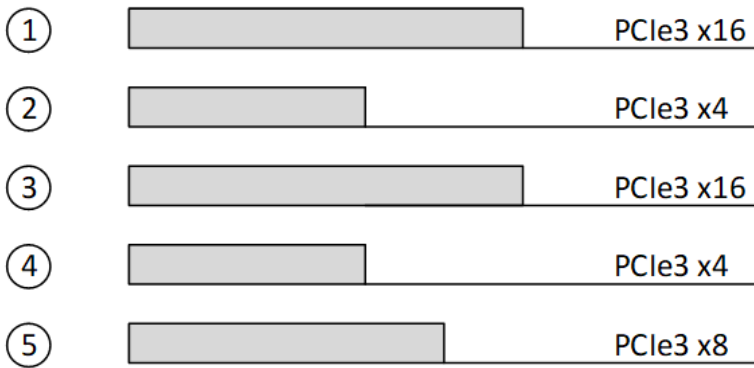

Slot	Configuration
Slot 1	<b>Graphics Card only!</b> (Single / Dual Slot)
Slot 2	Used if Dual Slot GPU is installed
Slot 3	Possible Expansion Card Installation: G-Sync Blue Storm Sea Level Single Port Network Card Video Cards (Matrox Video Boards)
Slot 4	Expansion Cards (see Slot 3, except Matrox Video Board)
Slot 5	Matrox AES Audio

### Default Hardware

- Tower 4RU
- CPU Render: 1x Intel Xeon W-2133 (3.6GHz 6-Core) or Intel Xeon W-2235 (3.8GHz 6-Core)
- CPU Control: 1x Intel Xeon W-2102 (2.9GHz 4-Core) or Intel Xeon W-2223 (3.6GHz 4-Core)
- RAM Render: 32 GB DDR 4 (4x 8GB)
- RAM Control: 16 GB DDR 4 (2x 8GB)
- SSD1: 512 GB M.2 NVMe (Operating System)
- SSD2: 512 GB M.2 NVMe (Data and Clips, only in Render PC)

- RAID Controller: Intel SATA/NVMe M.2
- Power Supply: 1x 750W 90% Efficient

## BIOS Configuration

- During Post, press **F10** to access BIOS Setup.
- Go back to **Advanced Tab > Secure Boot Configuration**.
  - Select: **Legacy Support Disable and Secure Boot Enable**.
- Go back to **Advanced Tab Overview**.
  - Click on **Build in Device**.
- Increase **PCIe Idle Fan Speed** to: 0050 .
- Press **ESC** and save Configuration.

 **Info:** Certain third party vendor drivers require secure boot to be disabled to install properly.



6.3.3 HP Z4 G5



Slot/Card Installation

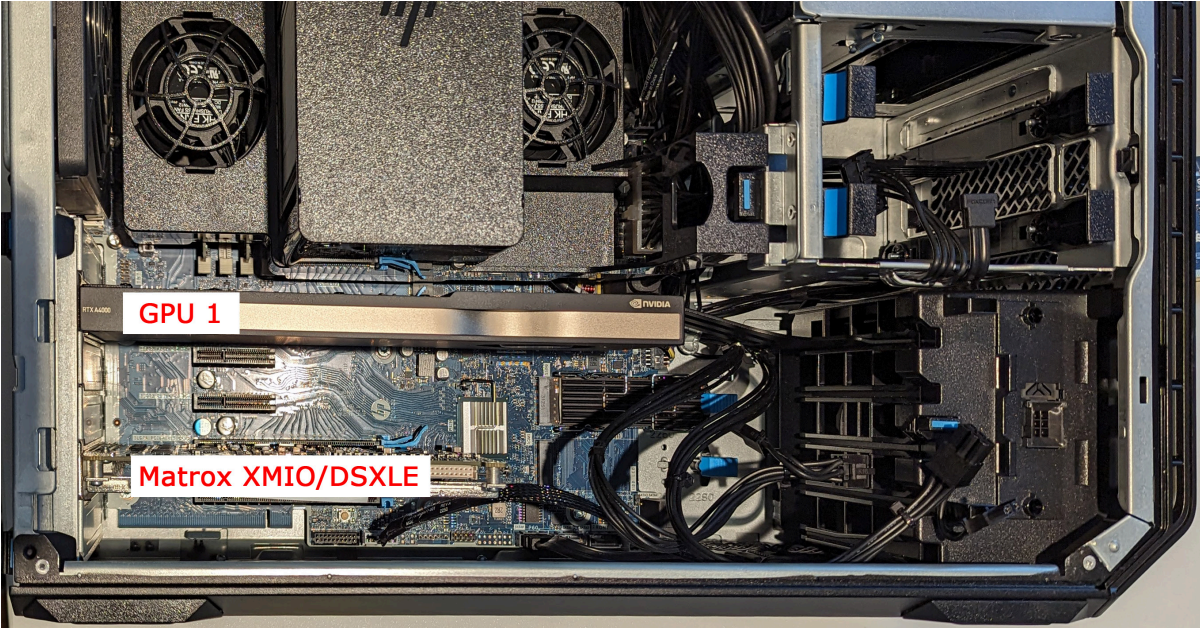

## HP Z4 G5 Workstation

Side access panel must be installed for the system to power ON

<p><b>I/O</b></p> <ul style="list-style-type: none"> <li>1 Front Audio</li> <li>2 Front USB</li> <li>3 Front IO-Premium</li> <li>4 Internal USB 2.0</li> <li>5 Internal USB 3.2 Gen1</li> <li>6 Network</li> <li>7 NVMe0</li> <li>8 Rear Audio</li> <li>9 Rear USB 3.1 Gen1</li> <li>10 Serial + PS2</li> <li>11 Thunderbolt GPIO</li> <li>12 Flex I/O</li> </ul> <p><b>Storage</b></p> <ul style="list-style-type: none"> <li>13 HDD LED</li> <li>14 SATA 6Gb/s</li> <li>15 VROC</li> </ul> <p><b>PCIe Slots</b></p> <ul style="list-style-type: none"> <li>16 Slot 1 - PCIe5 x16 CPU</li> <li>17 Slot 2 - PCIe4 x4 PCH</li> <li>18 Slot 3 - PCIe4 x4 PCH</li> <li>19 Slot 4 - PCIe4 x16 CPU</li> <li>20 Slot 5 - PCIe4 x16 CPU</li> </ul> <p><b>PCIe Module Slots</b></p> <ul style="list-style-type: none"> <li>21 PCIe M.2 Sockets</li> </ul> <p><b>Diagnostic LED and Audible Codes</b></p> <p style="font-size: xx-small;">Provide diagnostic information through the Front Panel LED (blinks) and System Speaker (beeps). The codes will be in a major/minor format with the major being Red blinks with long/low pitch beeps, and minor being White blinks with short/high pitch beeps. Please reference the POST Error section of the Maintenance and Service Guide (MSG) for more information.</p>	<p><b>Cooling</b></p> <ul style="list-style-type: none"> <li>22 CPU Fan</li> <li>23 Memory Fans</li> <li>24 System Fan - Front</li> <li>25 System Fan - Rear</li> <li>26 AUX Cooling (PCIe Retainer Fans)</li> </ul> <p><b>Power</b></p> <ul style="list-style-type: none"> <li>27 Battery</li> <li>28 Control Panel/LED</li> <li>29 CPU/Memory Power</li> <li>30 Power Command</li> <li>31 Main Power</li> <li>32 Rear Power Button/LED</li> <li>33 Internal Bay Power</li> <li>34 External Bay Power</li> </ul> <p><b>Service/Security</b></p> <ul style="list-style-type: none"> <li>35 Chassis Solenoid Lock</li> <li>36 Chassis Interlock Sensor</li> <li>37 Clear CMOS</li> <li>38 Password Jumper</li> <li>39 Remote</li> </ul>
--------------------------------------------------------------------------------------------------------------------------------------------------------------------------------------------------------------------------------------------------------------------------------------------------------------------------------------------------------------------------------------------------------------------------------------------------------------------------------------------------------------------------------------------------------------------------------------------------------------------------------------------------------------------------------------------------------------------------------------------------------------------------------------------------------------------------------------------------------------------------------------------------------------------------------------------------------------------------------------------------------------------------------------------------------------------------------------------------------------------------------------------------------------------------------------------------------------------------------------------------------------------------------------------------------------	----------------------------------------------------------------------------------------------------------------------------------------------------------------------------------------------------------------------------------------------------------------------------------------------------------------------------------------------------------------------------------------------------------------------------------------------------------------------------------------------------------------------------------------------------------------------------------------------------------------------------------------------------------------------------------------------------------------------------------------

For additional information and support please visit: <http://www.hp.com/support>

### System Board Overview

<b>Major . minor</b>	2.x	3.2	3.3	3.4	3.5	3.7	4.x	5.x
<b>Diagnosis</b>	BIOS	Memory	Graphics	Pwr Supply	No CPU	Side Panel	Thermal	Sys Brd

## Slot Configuration

Slot	Usage
Slot 1 Gen5 x16	Graphics Card
Slot 2 Gen4 x8 (PCH)	Free or used by Dual Slot GPU
Slot 3 Gen4 x8 (PCH)	Other Expansion Card (Serial, GPI)
Slot 4 Gen4 x16	Matrox Video Card (X.mio3, X.mio5, DSX LE4) only runs x8 speed if Slot 3 is used
Slot 5 Gen4 x16	Other Expansion Card (Serial, GPI)

## Default Hardware

- Single CPU 10-Cores
- Dual redundant Power Supply
  - 675W Platinum redundant, hot-swap
- PCIe Gen4+Gen5 Slots
- 5 PCIe Slots
- 64GB DDR5 1x512GB M.2 + 1x 1TB M.2
- 1x Gbit RJ45 onboard
- 1x 10Gbit RJ45 Flex IO
- OS Support:
  - Windows 10 LTSC 2021
  - Windows 11 LTSC 2024
- SlotGPU Support:
  - A2000
  - A4000
  - A5000
  - A6000
  - 6000 Ada

## Bios Settings

- Security/Secure Boot Configuration Secure Boot: Enable
- Advanced/Built-In Device Options:
  - Increase PCIe Idle Fan Speed(%): 30
- Advanced/Power Management Options:
  - Hardware P-States: Disable
  - S4/S5 Maximum Power Savings: Disable

- PCI Express Power Management: Disable
- Advanced/Performance Options:
  - Workload Configuration: I/O-Focused



### 6.3.4 HP Z4 Rack G5



#### Slot/Card Configuration

Slot	Usage
Slot 1 - Gen5 x16	Graphics Card (single Slot only)
Slot 2 - Gen5 x16 or x8	Matrox Video Card (X.mio3, X.mio5, DSX LE4) only runs x8 speed if Slot 3 is used
Slot 3 - Gen5 x8	Other Expansion Card (Serial, GPI)

**Information:** Matrox AES Audio can not be installed. Larger Graphic cards will not run in Power redundant mode and are not tested by Vizrt.

#### Default Hardware

- Single CPU 10-Cores
- Dual redundant Power
  - Supply 675W Platinum redundant, hot-swap
- PCIe Gen5 Slots
- Three PCIe Slots
- 64GB DDR5
- 1x 512GB M.2 (Front) + 1x 1TB M.2 (internal)
- 1x Gbit RJ45 onboard
- 1x 10Gbit RJ45 Flex IO Slot
- OS Support:
  - Windows 10 LTSC 2021
  - Windows 11 LTSC 2024

- GPU Support:
  - A4000
  - 4000 Ada

## Bios Settings

- Security/Secure Boot Configuration Secure Boot: Enable
- Advanced/Built-In Device Options:
  - Increase PCIe Idle Fan Speed(%): 30
- Advanced/Power Management Options:
  - Hardware P-States: Disable
  - S4/S5 Maximum Power Savings: Disable
  - PCI Express Power Management: Disable
- Advanced/Performance Options:
  - Workload Configuration: I/O-Focused
- Advanced/Power Supply Options:
  - Power Supply Mode: Redundant

### 6.3.5 HP Z8 G4

This section describes how to setup a HP Z8 G4 machine with the different cards provided by Vizrt. The HP Z8 G4 is a high performance workstation that can be configured with two CPUs, has 24 memory slots, multiple storage and PCIe configuration options.

More details about the HP Z8 can be found on HP's website: [HP Z8](#).



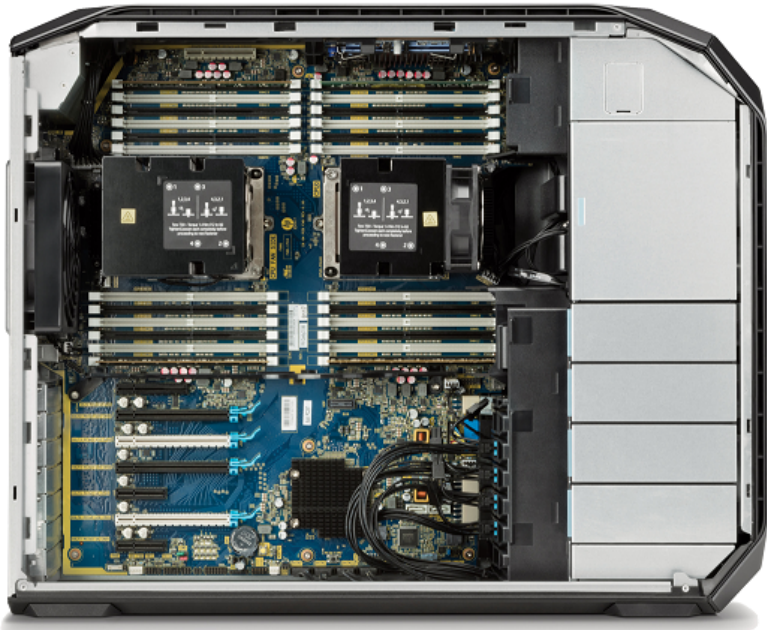

**Info:** Only newer Matrox Boards like X.mio3 and DSX LE4 are shipped with Z8 workstations. Older videoboard are not tested by Vizrt.

- ①  PCIe3 x8
- ②  PCIe3 x16
- ③  PCIe3 x16
- ④  PCIe3 x16
- ⑤  PCIe3 x4
- ⑥  PCIe3 x16
- ⑦  PCIe3 x4



## PCI Configuration for Single GPU

Slot	Usage
Slot 1 - PCIe3 x8	Matrox AES Audio G-Sync III Blue Storm Sea Level Single Port Network Card
Slot 2 - PCIe3 x16	Graphics Card (Single / Dual Slot)
Slot 3 - PCIe3 x16	Used if Dual Slot GPU is installed
Slot 4 - PCIe3 x16	If one Graphic Card is installed, this slot is used for Video Cards (Matrox Video Boards)
Slot 5 - PCIe3 x4	Empty or can be used by Matrox AES Audio if Slot 1 is used
Slot 6 - PCIe3 x16	Empty
Slot 7 - PCIe3 x4	Empty

## PCI Configuration for Single GPU with M264

Slot	Usage
Slot 1 - PCIe3 x8	Matrox Video Card
Slot 2 - PCIe3 x16	Empty
Slot 3 - PCIe3 x16	Primary Graphics Card (Single / Dual Slot)
Slot 4 - PCIe3 x16	Primary Graphics Card (Dual Slot)
Slot 5 - PCIe3 x4	Quadro Sync
Slot 6 - PCIe3 x16	M264
Slot 7 - PCIe3 x4	Empty

## PCI Configuration for Dual GPU

Slot	Usage
Slot 1 – PCIe3 x8	Video Cards (Matrox Video Boards)
Slot 2 – PCIe3 x16	Matrox AES Audio G-Sync III Blue Storm Sea Level Single Port Network Card
Slot 3 – PCIe3 x16	Primary Graphics Card (Single / Dual Slot)
Slot 4 – PCIe3 x16	Primary Graphics Card (Dual Slot)
Slot 5 – PCIe3 x4	Empty or used by Matrox AES Audio if Slot 2 is used by extension card (G-Sync, Blue Storm, etc.)
Slot 6 – PCIe3 x16	Secondary Graphics Card (Single / Dual Slot)
Slot 7 – PCIe3 x4	Secondary Graphics Card (Dual Slot)

## Default Hardware

- Tower 5RU
- CPU: 2x Intel Xeon Silver 4114 (2.2GHz 10-Core) or 2x Intel Xeon Silver 4210R (2.4GHz 10-Core)
- RAM: 64 GB DDR 4 (8x 8GB)
- SSD1: 512 GB M.2 NVMe (Operating System)
- SSD2: 512 GB M.2 NVMe (Data and Clips)
- RAID Controller: Intel SATA/NVMe M.2
- Power Supply: 1x 1125 W 90% Efficient

## BIOS – Configuration

- During Post, press **F10** to access BIOS Setup.
- Go back to **Advanced Tab > Secure Boot Configuration**.
  - Select: **Legacy Support Disable and Secure Boot Enable**.
- Go back to **Advanced Tab Overview**.
  - Click on **Build in Device**.
- Increase **PCIe Idle Fan Speed** to: 0050 .
- Go back to **Advanced Tab Overview**.
  - Click on **Performance Options**.
  - Set **Intel Hyper Threading Technology** to **DISABLED** .

- Press **ESC** and save Configuration.



**Info:** Certain third party vendor drivers require secure boot to be disabled to install properly.

6.3.6 HP Z8 G5 Fury



Slot/Card Installation

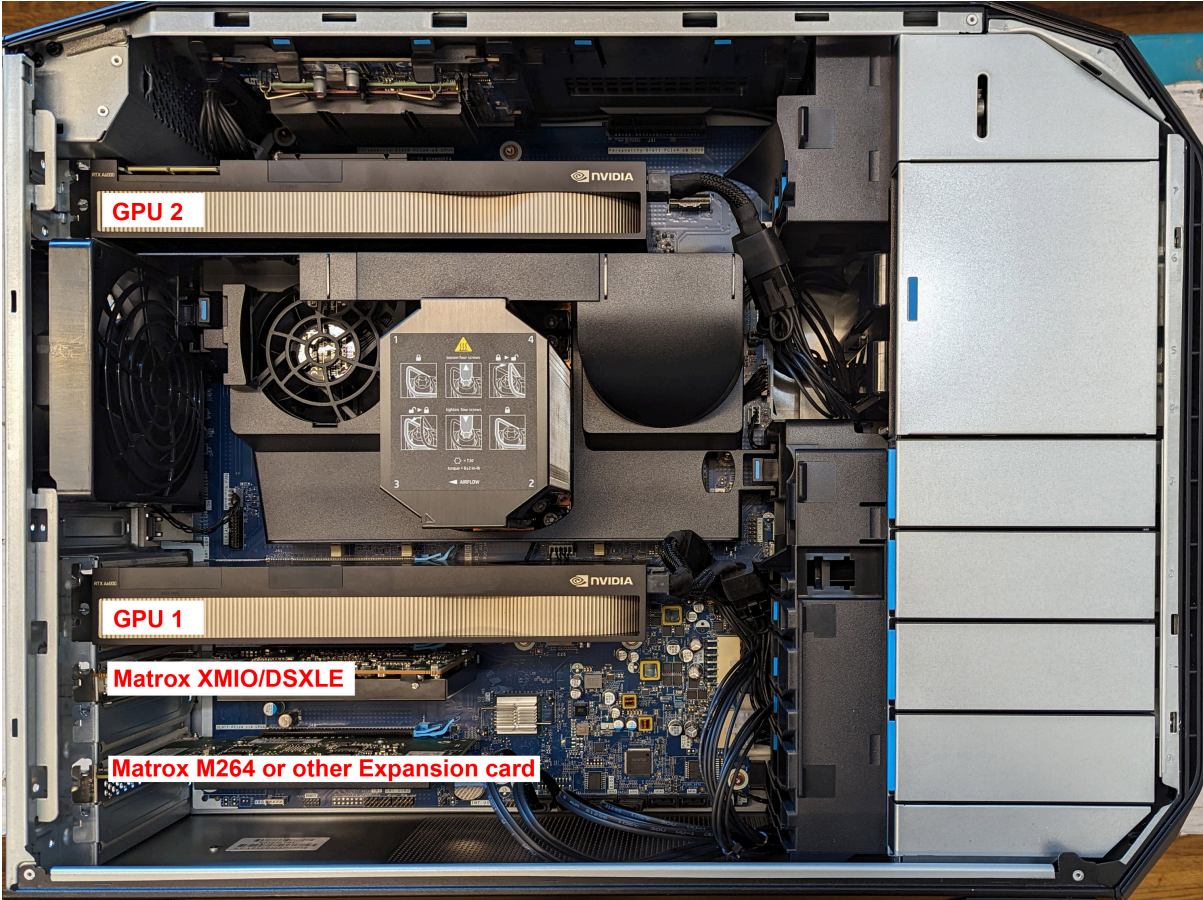



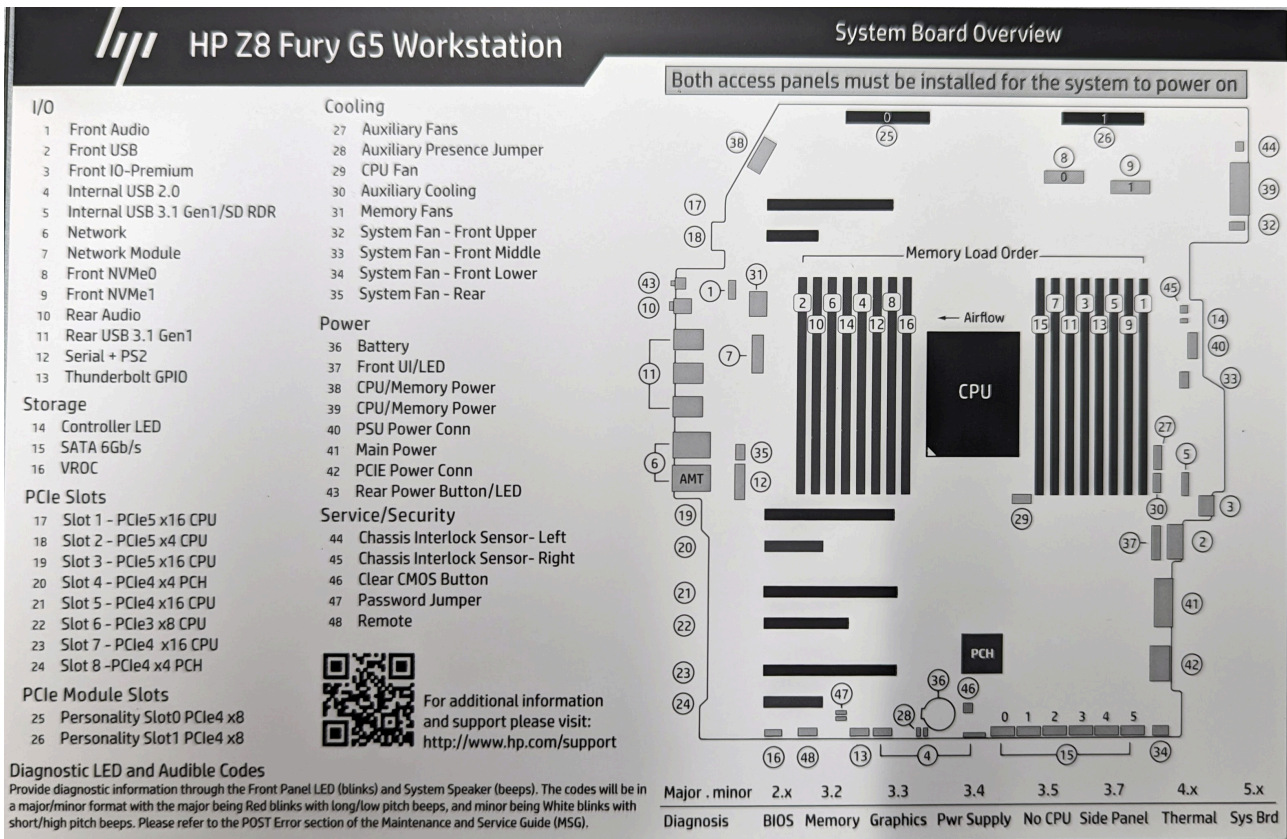

### Default Hardware

- Single CPU 20-Cores
- Dual redundant Power Supply
  - 1125/1450W Platinum redundant, hot-swap
- PCIe Gen4 + Gen5 Slots
- 8 PCIe Slots
- 64GB DDR5
- 1x 512GB M.2 + 1x 1TB M.2
- 2x Gbit RJ45 onboard
- OS Support:
  - Windows 10 LTSC 2021
  - Windows 11 LTSC 2024
- GPU Support:
  - A2000
  - A4000
  - A5000
  - A6000
  - 4000 Ada
  - 5000 Ada
  - 6000 Ada

## PCI Configuration

Slot	Usage
Slot 1 Gen5 x16	Second Graphics Card (no Monitor)
Slot 2 Gen5 x4	Free or used by Dual Slot GPU
Slot 3 Gen5 x16	First Graphics Card (with Monitor)
Slot 4 Gen4 x4 (PCH)	Free or used by Dual Slot GPU
Slot 5 Gen4 x16	Matrox Video Card (X.mio3, X.mio5, DSX LE4)
Slot 6 Gen3 x8	Empty
Slot 7 Gen4 x16	Matrox M264 or other Expansion Card (Serial, GPI)
Slot 8 Gen4 x4 (PCH)	Other Expansion Card (Serial, GPI)

## Bios Settings

- Security/Secure Boot Configuration Secure Boot: Enable
- Advanced/Built-In Device Options:
  - Increase PCIe Idle Fan Speed(%): 50
  - PCIe Idle Fan Tracking mode: Enable
- Advanced/Power Management Options:
  - Hardware P-States: Disable
  - S4/S5 Maximum Power Savings: Disable
  - PCI Express Power Management: Disable
- Advanced/Performance Options:
  - Workload Configuration: I/O-Focused
- Advanced/Power Supply Options:
  - Power Supply Mode: Redundant

### 6.3.7 HP ZCentral 4R

This section describes the specification and PCIe board layout of a HP ZCentral 4R machine with the different cards provided by Vizrt.

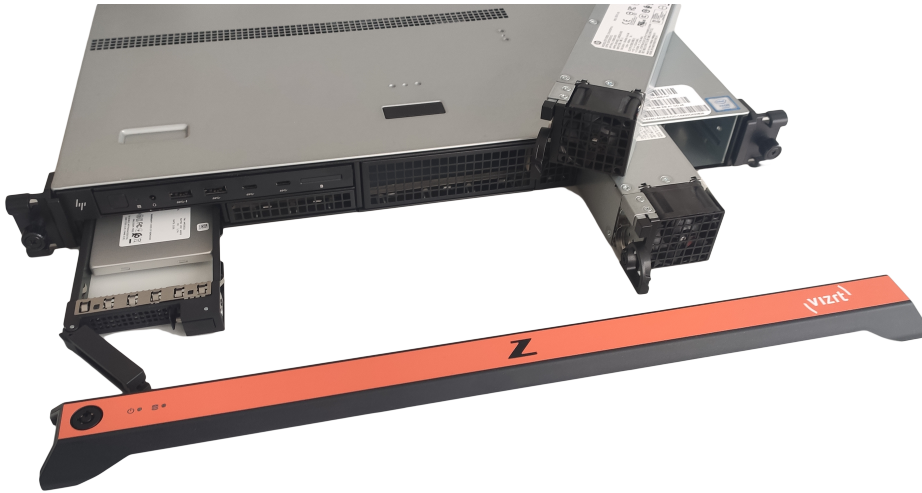

#### Default Hardware

- Server 1RU
- OS: Windows 10 IoT Enterprise LTSC 2021
- CPU: 1x Intel Xeon W-2235 6-Core
- RAM: 32 GB DDR 4 (2x 16GB)
- 1st SSD: 512 GB M.2 on Mainboard
- 2nd SSD: 512 GB M.2 on Mainboard
- RAID Controller: Intel Onboard
- Hot Plug Power Supply: 2x 675W



## Connectors

### Front Connectors

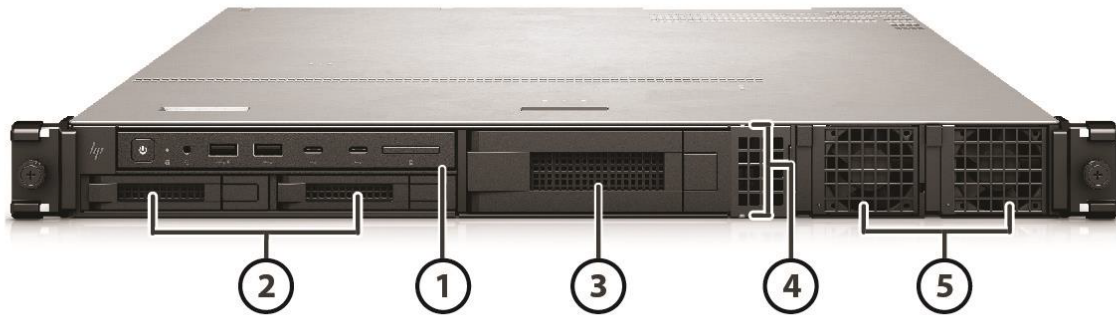

1. Front I/O module power button, 2 USB-A 3.1 G1, 2 USB-C 3.1 G2, Headset audio
2. 2 x 2.5" external drive bays
3. Optional 1 x 3.5" or 2 x 2.5" drive bay
4. Locator LED
5. 2 x external 675W PSU bays

### Back Connectors

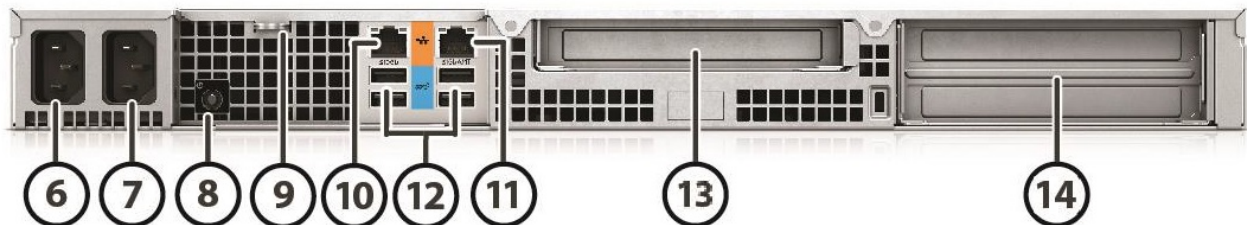

6. Primary PSU connector
7. Secondary PSU connector
8. Rear power button
9. Padlock loop
10. 1GbE RJ-45 (AMT)
11. 1/2.5/5/10GbE RJ-45
12. 4x USB 3.1 G1 Type-A
13. Single Slot Riser (1 PCIe G3 x16)
14. Dual Slot Riser

- 1 x PCIe G3 x16\*
- 1 x PCIe G3 x16 wired as x8

**Info:** Slot 2 runs at Gen3 x8 Speed, if Slot 3 is loaded.

### PCIe Configuration with A4000

Slot	Usage
Slot 1	Graphics Card (Single Slot)
Slot 2	Matrox Video Card (X.mio3, X.mio5, DSX LE4) or other PCIe card
Slot 3	Matrox AES Audio or other PCIe card

### PCIe Configuration with A2000 or A5000

Slot	Usage
Slot 1	Matrox Video Card (X.mio3, X.mio5, DSX LE4) or other PCIe card
Slot 2	Graphics Card (Dual Slot)
Slot 3	Graphics Card (Dual Slot)

**Info:** Dual A4000 or Single A6000 GPU configurations will not run power redundant and are not tested by Vizrt.

### BIOS Settings

- During post, press **F10** to access BIOS setup.
- Click **Advanced tab > Boot Options**: Enable the Fast Boot.
- Go back to **Advanced tab > Secure Boot Configuration**. Select **Legacy Support Disable** and **Secure Boot Enable**.
- Go back to **Advanced tab > Build in Device Options**. Increase **PCIe Idle Fan Speed** to 0020.
- Press **ESC** and save configuration.

**Info:** Certain third party vendor drivers require secure boot to be disabled to install properly.

### 6.3.8 Lenovo P3 Ultra

The Lenovo P3 Ultra is a performance workstation that is utilized in Vizrt's Go product lines. More details about the Lenovo P3 Ultra can be found on Lenovo's website: [Lenovo P3 Ultra](#).



#### Default Hardware

- CPU: Intel i5-13600
- RAM: 32 GB (2x 16GB)
- Disk: 1TB NVMe SSD
- GPU: Lenovo NVIDIA RTX 4000 Ada SFF 20GB or NVIDIA RTX A2000
- OS Support:
  - Windows 10 LTSC 2021
  - Windows 11 LTSC 2024

#### Slot Configuration



Slot	Usage
Slot 1 (Top left) PCIe Gen4 x16 Low Profile Double Wide	NVIDIA RTX 4000 Ada SFF 20GB or NVIDIA RTX A2000
Slot 2 (Bottom right) PCIe Gen3 x4 Low Profile	Other Expansion Card (Serial, GPI)

## Bios Settings

- Advanced - CPU Setup
  - Efficient-Cores: Disabled

### 6.3.9 Lenovo P620

This section describes how to setup a Lenovo P620 machine with the different cards provided by Vizrt. The Lenovo P620 is a high performance workstation that can be configured with two CPUs, has eight memory slots, multiple storage and PCIe configuration options.

More details about the Lenovo P620 can be found on Lenovo’s website: [Lenovo P620](#).



**Info:** Only newer Matrox Boards like X.mio3 and DSX LE4 are shipped with P620 workstations. Older videobards are not tested by Vizrt.

1		PCIe 4.0 x16
2		PCIe 4.0 x8
3		PCIe 4.0 x16
4		PCIe 4.0 x16
5		PCIe 4.0 x16
6		PCIe 4.0 x8

## PCI Configuration for Single GPU

Slot	Usage
Slot 1 - PCIe4 x16	Matrox AES Audio G-Sync III Blue Storm Sea Level Single Port Network Card
Slot 2 - PCIe4 x8	Empty
Slot 3 - PCIe4 x16	Graphics Card (Single / Dual Slot)
Slot 4 - PCIe4 x16	Used if Dual Slot GPU is installed
Slot 5 - PCIe4 x16	If one Graphic Card is installed, this slot is used for Video Cards (Matrox Video Boards)
Slot 6 - PCIe4 x8	Empty or can be used by Matrox AES Audio if Slot 1 is used

## PCI Configuration for Single GPU with M264

Slot	Usage
Slot 1 - PCIe4 x16	M264
Slot 2 - PCIe4 x8	Matrox AES Audio Blue Storm Sea Level Single Port Network Card
Slot 3 - PCIe4 x16	Primary Graphics Card (Single / Dual Slot)
Slot 4 - PCIe4 x16	Primary Graphics Card (Dual Slot)
Slot 5 - PCIe4 x16	Video Card (Matrox DSX LE4)
Slot 6 - PCIe4 x8	Quadro Sync

## PCI Configuration for Dual GPU

Slot	Usage
Slot 1 - PCIe4 x16	Primary Graphics Card (Single / Dual Slot)
Slot 2 - PCIe4 x8	Primary Graphics Card (Dual Slot)
Slot 3 - PCIe4 x16	Video Card (Matrox)
Slot 4 - PCIe4 x16	Matrox AES Audio G-Sync III Blue Storm Sea Level Single Port Network Card
Slot 5 - PCIe4 x16	Secondary Graphics Card (Single / Dual Slot)
Slot 6 - PCIe4 x8	Secondary Graphics Card (Dual Slot)

## Default Hardware

- Tower 4RU
- CPU: AMD Threadripper Pro 3955WX (16-Core, 3.90GHz, 8MB) or 5955WX (16-Core, 4.00GHz, 8MB)
- RAM: 64 GB DDR 4 (4x 16GB)
- SSD1: 512 GB M.2 NVMe (Operating System)
- SSD2: 512 GB M.2 NVMe (Data and Clips)
- Power Supply: 1x 1000W Power Supply
- OS Support:
  - Windows 10 LTSC 2021
  - Windows 11 LTSC 2024

**i Info:** Certain third party vendor drivers require secure boot to be disabled to install properly.

## 6.3.10 Lenovo SR655 V3

### Slot/Card Installation



### Default Hardware

- Single CPU 16-Cores AMD EPYC 9124 3GHz
- Dual Redundant Power Supplies, hot swap (220V ONLY! 1800W C13 connector)
- PCIe Gen4 + Gen5 Slots
- 6 PCIe Slots + 2 Slots for Double Wide GPU
- 64GB DDR5 (4x 16GB) up to 12x 16GB
- 2x 920GB U.2 Front Mount Hot Swap
- 4x Gbit RJ45 onboard in OCP Slot
- GPU Support:
  - A2000
  - A4000
  - A6000
  - 6000 Ada
  - Virtualized with ESXi:
    - A40
    - A6000
- OS Support:
  - Windows 11 LTSC 2024
  - Windows 10 LTSC 2021
  - Win Server 2022
  - ESXi

### Slot Configuration

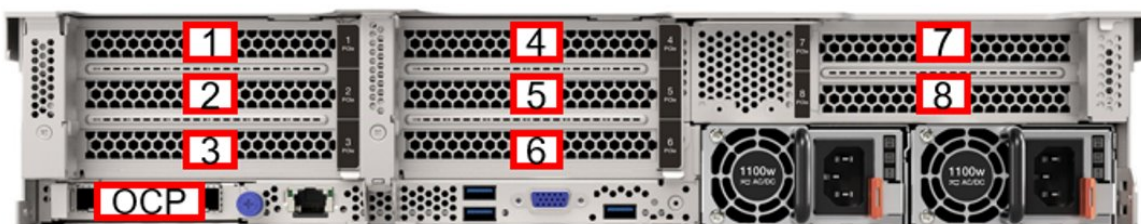



Slot	Usage
Slot 1	Unused or used by Dual Slot GPU
Slot 2 Gen5 x16	First Graphics Card (with Monitor)
Slot 3 Gen4 x16	Raid Controller
Slot 4	Unused or used by Dual Slot GPU
Slot 5 Gen5 x16	Second Graphics Card (no Monitor)
Slot 6 Gen4 x16	Other Expansion Card (Serial, GPI)
Slot 7 Gen5 x16	Matrox Video Card (X.mio5), Matrox M264 or other Expansion Card (Serial, GPI)
Slot 8 Gen4 x16	Matrox Video Card (X.mio3, DSX LE4), Matrox M264 or other Expansion Card (Serial, GPI)

## Bios Settings

- System Settings / Devices and I/O Ports
  - Active Video: Add-in Device
- System Settings / Enable/Disable Onboard Devices
  - Onboard Video: Disabled
- System Settings / Operating Modes
  - Choose Operating Mode: Maximum Performance
- System Settings / Power
  - PCIe Power Brake: Disabled

---

## 6.4 Video Boards

This section describes the all supported Video IO boards, their configuration and drivers supported by Viz Engine.

 **IMPORTANT!** Any other setup than those described is not guaranteed to be supported by Vizrt and may cause problems during operation.

 **Note:** Vizrt may make changes to specifications and product descriptions at any time, without notice.

This section contains information on the following topics:

- [SMPTE ST 2110 Configuration](#)
- [Matrox Hardware](#)
- [BlueFish444](#)
- [Aja Hardware](#)

### 6.4.1 SMPTE ST 2110 Configuration

The configuration of the IP settings was moved to an XML file containing IP relevant parameters only. The file *ipconfig.xml* can be found in *%ProgramData%\Vizrt\VizEngine*.

**⊗ Warning:** When editing the XML file, do not delete any tags and only edit values between `<tag>` and `</tag>`.

**⊗ Important:** Never change any of the name parameters in the tags. For example, `<SFP name="SFP A">` or `<Video name="IP video OUT 1">`.

This section contains information on the following topics:

- [How to Setup X.mio5 Separate Flows](#)
- [NMOS Configuration](#)

#### General Settings

Setting	Description
AutoRecovery	When set to <code>true</code> , every change for parameters (either set by direct command or NMOS requests) is saved to the config file. When Viz Engine is restarted, those settings are used to configure the IP connectors.
Is07Receivers	Currently not in use.

#### SFP Settings

Setting	Description
IPv4Address	X.mio3: the static unicast IP v4 address used as source address and for the PTP connection. X.mio5: the static IP v4 address used for the PTP connection, if DHCP is disabled. Can be 0.0.0.0 otherwise.
IPV4Gateway	X.mio3: the static IP v4 gateway address used as source address and for the PTP connection. X.mio5: the static IP v4 gateway address used for the PTP connection, if DHCP is disabled. Can be 0.0.0.0 otherwise.
IPv4Netmask	X.mio3: the network subnet mask used for the source address and the PTP connection. X.mio5: the network subnet mask used for the PTP connection, if DHCP is disabled. Can be 0.0.0.0 otherwise.

Setting	Description
Smpte2059SfpSettings::DhcpEnable	X.mio5 only: enables DHCP support for the SFP unicast PTP settings. X.mio3 and DSX LE 4 don't support DHCP and need static configuration using the fields described above.
Smpte2059SfpSettings::TypeOfServiceDSCP	Indicates that the Type of Service (ToS) is Differentiated Service Code Point (DSCP). Range is [0..63] (6 bits).
Smpte2059SfpSettings::DelayMechanism	Indicates the type of delay mechanism to use for the time server connection. 0 = Invalid 1 = EndToEnd 2 = PeerToPeer
Smpte2059SfpSettings::IpMode	Indicates the type of internet protocol mode to use for the time server connection. 0 = Invalid 1 = Multicast 2 = Unicast 3 = Hybrid
Smpte2059SfpSettings::MasterClockDomainNumber	Indicates the time server clock domain number to use.
Smpte2059SfpSettings::AnnounceReceiptTimeout	Number of 'Announce intervals' to wait: Range is [2..10] with a default of 6.
Smpte2059SfpSettings::JoinType	Indicates the type of membership request made. 0 = Invalid 1 = None 2 = IGMPv2 3 = IGMPv3
Smpte2059SfpSettings::IgmPV3Settings::FilterType	Only needed when the join type is set to 3 = IGMPv3. Indicates the filter type applied. 0 = Invalid 1 = Inclusion 2 = Exclusion
Smpte2059SfpSettings::IgmPV3Settings::FilterListCount	Indicates the number of IPv4 source addresses in the filter list. Maximum is four.
Smpte2059SfpSettings::IgmPV3Settings::FilterList	Indicates the list of IPv4 source addresses to filter separated by commas.

**✘ Important:** The IPv4 settings for the source port on X.mio5 must be set in the Windows 10 network settings. If DHCP is not available on the essence network, static addresses must be used. **Every SFP of an X.mio5 needs two unicast IPv4 addresses.** One is for the PTP settings set in *ipconfig.xml*, and the other is set in the Windows 10 network settings, used as source address (for example, the address used in an IGMPv3 environment for source specific multi-casting).

## General Output Settings

Setting	Description
Redundancy	If set to <code>true</code> , enables the redundant stream for seamless reconstruction conforming to SMPTE ST 2022-7.

## Video Output Settings

Setting	Description
EnableFlow	Set to <code>true</code> to enable the flow at startup. This can be controlled using a command during run-time.
RtpPayloadId	Indicates the RTP (Real-time Transfer Protocol) payload ID.
TimeToLive	Indicates the time in which packets can be used in seconds. That is, it indicates the packets' Time to live (TTL).
TypeOfServiceDSCP	Indicates that the Type of Service (ToS) is Differentiated Service Code Point (DSCP). Range is [0..63] (6 bits).
TypeOfServiceECN	Indicates that the Type of Service (ToS) is Explicit Congestion Notification (ECN). Range is [0..3] (2 bits).
GroupHint	Unique name used as identifier for a group of flows belonging together.
Primary::SrcUdpPort	Indicates the User Datagram Protocol (UDP) port of the sender (that is, transmitter).
Primary::DstAddress	Indicates the IPv4 address of the destination (that is, receiver). Only used in multicast.
Primary::DstUdpPort	Indicates the UDP port of the destination (that is, receiver).

Setting	Description
Secondary::SrcUdpPort	Indicates the redundant stream UDP port of the sender (that is, transmitter).
Secondary::DstAddress	Indicates the redundant stream IPv4 address of the destination (that is, receiver). Only used in multicast.
Secondary::DstUdpPort	Indicates the redundant stream UDP port of the destination (that is, receiver).

### Audio Output Settings

Setting	Description
EnableFlow	Set to <code>true</code> , to enable the flow at startup. This can be controlled using a command during run-time.
RtpPayloadId	Indicates the RTP (Real-time Transfer Protocol) payload ID.
TimeToLive	Indicates the time in which packets can be used in seconds. That is, it indicates the packets' Time to live (TTL).
TypeOfServiceDSCP	Indicates that the Type of Service (ToS) is Differentiated Service Code Point (DSCP). Range is [0..63] (6 bits).
TypeOfServiceECN	Indicates that the Type of Service (ToS) is Explicit Congestion Notification (ECN). Range is [0..3] (2 bits).
GroupHint	Unique name used as identifier for a group of flows belonging together.
AudioPacketDuration	Indicates the outgoing audio packet duration. 1 = 125 $\mu$ s 4 = 1 ms All other values are not supported.
TrackCount	Indicates the number of tracks in that flow.
Primary::SrcUdpPort	Indicates the User Datagram Protocol (UDP) port of the sender (that is, transmitter).

Setting	Description
Primary::DstAddress	Indicates the IPv4 address of the destination (that is, receiver). Only used in multicast.
Primary::DstUdpPort	Indicates the UDP port of the destination (that is, receiver).
Secondary::SrcUdpPort	Indicates the redundant stream UDP port of the sender (that is, transmitter).
Secondary::DstAddress	Indicates the redundant stream IPv4 address of the destination (that is, receiver). Only used in multicast.
Secondary::DstUdpPort	Indicates the redundant stream UDP port of the destination (that is, receiver).

#### Ancillary Data Output Settings

Setting	Description
EnableFlow	Set to <code>true</code> , to enable the flow at startup. This can be controlled using a command during run-time.
RtpPayloadId	Indicates the RTP (Real-time Transfer Protocol) payload ID.
TimeToLive	Indicates the time in which packets can be used in seconds. That is, it indicates the packets' Time to live (TTL).
TypeOfServiceDSCP	Indicates that the Type of Service (ToS) is Differentiated Service Code Point (DSCP). Range is [0..63] (6 bits).
TypeOfServiceECN	Indicates that the Type of Service (ToS) is Explicit Congestion Notification (ECN). Range is [0..3] (2 bits).
GroupHint	Unique name used as identifier for a group of flows belonging together.
SMPTE352Payload	If set to 1, enables SMPTE 352 packets.
Primary::SrcUdpPort	Indicates the User Datagram Protocol (UDP) port of the sender (that is, transmitter).

Setting	Description
Primary::DstAddress	Indicates the IPv4 address of the destination (that is, receiver). Only used in multicast.
Primary::DstUdpPort	Indicates the UDP port of the destination (that is, receiver).
Secondary::SrcUdpPort	Indicates the redundant stream UDP port of the sender (that is, transmitter).
Secondary::DstAddress	Indicates the redundant stream IPv4 address of the destination (that is, receiver). Only used in multicast.
Secondary::DstUdpPort	Indicates the redundant stream UDP port of the destination (that is, receiver).

### General Input Settings

Setting	Description
Redundancy	If set to <code>true</code> , enables the redundant stream for seamless reconstruction conforming to SMPTE ST 2022-7.
JoinType	Indicates the type of membership request made. 0 = Invalid 1 = None 2 = IGMPv2 3 = IGMPv3

### Video Input Settings

Setting	Description
EnableFlow	Set to <code>true</code> , to enable the flow at startup. This can be controlled using a command during run-time.
RtpPayloadId	Indicates the RTP (Real-time Transfer Protocol) payload ID.
GroupHint	Unique name used as identifier for a group of flows belonging together.
Primary::DstAddress	Indicates the reception multicast IPv4 address.



Setting	Description
Primary::DstUdpPort	Indicates the reception User Datagram Protocol (UDP) port.
Primary::PacketIntervalThreshold	Indicates the threshold for generating the time interval between the IP packets alarm on the video flow. The range is from 6.4 ns to 419424.0 ns in intervals of 6.4 ns.
Primary::IcmpV3Settings::FilterType	Only needed when the join type is set to 3 = IGMPv3. Indicates the filter type applied. 0 = Invalid 1 = Inclusion 2 = Exclusion
Primary::IcmpV3Settings::FilterListCount	Indicates the number of IPv4 source addresses in the filter list. Maximum is four.
Primary::IcmpV3Settings::FilterList	Indicates the list of IPv4 source addresses to filter separated by commas.
Secondary::DstAddress	Indicates the redundant stream reception multicast IPv4 address.
Secondary::DstUdpPort	Indicates the redundant stream reception UDP port.
Secondary::PacketIntervalThreshold	Indicates the threshold for generating the time interval between the IP packets alarm on the video flow. The range is from 6.4 ns to 419424.0 ns in intervals of 6.4 ns.
Secondary::IcmpV3Settings::FilterType	Only needed when the join type is set to 3 = IGMPv3. Indicates the filter type applied. 0 = Invalid 1 = Inclusion 2 = Exclusion
Secondary::IcmpV3Settings::FilterListCount	Indicates the number of IPv4 source addresses in the filter list. Maximum is four.
Secondary::IcmpV3Settings::FilterList	Indicates the list of IPv4 source addresses to filter separated by commas.

## Audio Input Settings

Setting	Description
EnableFlow	Set to <code>true</code> , to enable the flow at startup. This can be controlled using a command during run-time.
RtpPayloadId	Indicates the RTP (Real-time Transfer Protocol) payload ID.
GroupHint	Unique name used as identifier for a group of flows belonging together.
AudioPacketDuration	Indicates the outgoing audio packet duration. 1 = 125 $\mu$ s 4 = 1 ms All other values are not supported.
TrackCount	Indicates the number of tracks allowed in that flow.
Primary::DstAddress	Indicates the reception multicast IPv4 address.
Primary::DstUdpPort	Indicates the reception User Datagram Protocol (UDP) port.
Primary::PacketIntervalThreshold	Indicates the threshold for generating the time interval between the IP packets alarm on the audio flow. The range is from 102.4 ns to 6710681.6 ns in intervals of 102.4 ns.
Primary::IcmpV3Settings::FilterType	Only needed when the join type is set to 3 = IGMPv3. Indicates the filter type applied. 0 = Invalid 1 = Inclusion 2 = Exclusion
Primary::IcmpV3Settings::FilterListCount	Indicates the number of IPv4 source addresses in the filter list. Maximum is four.
Primary::IcmpV3Settings::FilterList	Indicates the list of IPv4 source addresses to filter separated by commas.
Secondary::DstAddress	Indicates the redundant stream reception multicast IPv4 address.
Secondary::DstUdpPort	Indicates the redundant stream reception UDP port.

Setting	Description
Secondary::PacketIntervalThreshold	Indicates the threshold for generating the time interval between the IP packets alarm on the audio flow. The range is from 102.4 ns to 6710681.6 ns in intervals of 102.4 ns.
Secondary::IcmpV3Settings::FilterType	Only needed when the join type is set to 3 = IGMPv3. Indicates the filter type applied. 0 = Invalid 1 = Inclusion 2 = Exclusion

### Ancillary Data Input Settings

Setting	Description
EnableFlow	Set to <code>true</code> , to enable the flow at startup. This can be controlled using a command during run-time.
RtpPayloadId	For SMPTE ST 2110 only: Indicates the RTP (Real-time Transfer Protocol) payload ID.
GroupHint	Unique name used as identifier for a group of flows belonging together.
Primary::DstAddress	Indicates the reception multicast IPv4 address.
Primary::DstUdpPort	Indicates the reception User Datagram Protocol (UDP) port.
Primary::PacketIntervalThreshold	Indicates the threshold for generating the time interval between the IP packets alarm on the ancillary data flow. The range is from 819.2 ns to 53685452.8 ns in intervals of 819.2 ns.
Primary::IcmpV3Settings::FilterType	Only needed when the join type is set to 3 = IGMPv3. Indicates the filter type applied. 0 = Invalid 1 = Inclusion 2 = Exclusion
Primary::IcmpV3Settings::FilterListCount	Indicates the number of IPv4 source addresses in the filter list. Maximum is four.

Setting	Description
Primary::IgmPV3Settings::FilterList	Indicates the list of IPv4 source addresses to filter separated by commas.
Secondary::DstAddress	Indicates the redundant stream reception multicast IPv4 address.
Secondary::DstUdpPort	Indicates the redundant stream reception UDP port.
Secondary::PacketIntervalThreshold	Indicates the threshold for generating the time interval between the IP packets alarm on the ancillary data flow. The range is from 819.2 ns to 53685452.8 ns in intervals of 819.2 ns.
Secondary::IgmPV3Settings::FilterType	Only needed when the join type is set to 3 = IGMPv3. Indicates the filter type applied. 0 = Invalid 1 = Inclusion 2 = Exclusion

## Change IP Properties

Although the IP properties may be changed by editing the configuration file directly, the IP address and port numbers can also be set via the command line interface. Because channel numbering is zero-based here, **Output Channel 1** is referred to as `VIDEOOUT_0`. To check the currently configured values call the command using GET (instead of SET) without parameters.

## To Change/Check the Destination Address and Port of the Output Channels

```

MAIN*CONFIGURATION*MATROX*VIDEOOUT_x*ENABLEDSTATE SET ON/OFF
MAIN*CONFIGURATION*MATROX*VIDEOOUT_x*DSTADDRESS SET xxx.xxx.xxx.xxx
MAIN*CONFIGURATION*MATROX*VIDEOOUT_x*DSTUDPPORT SET xxxxx
MAIN*CONFIGURATION*MATROX*VIDEOOUT_x*REDUNDANCYDSTADDRESS SET xxx.xxx.xxx.xxx
MAIN*CONFIGURATION*MATROX*VIDEOOUT_x*REDUNDANCYDSTUDPPORT SET xxxxx
MAIN*CONFIGURATION*MATROX*VIDEOOUT_x*DSTADDRESSKEY SET xxx.xxx.xxx.xxx
MAIN*CONFIGURATION*MATROX*VIDEOOUT_x*DSTUDPPORTKEY SET xxxxx
MAIN*CONFIGURATION*MATROX*VIDEOOUT_x*REDUNDANCYDSTADDRESSKEY SET
xxx.xxx.xxx.xxx
MAIN*CONFIGURATION*MATROX*VIDEOOUT_x*REDUNDANCYDSTUDPPORTKEY SET xxxxx
MAIN*CONFIGURATION*MATROX*VIDEOOUT_x*DSTADDRESSAUDIO SET xxx.xxx.xxx.xxx
MAIN*CONFIGURATION*MATROX*VIDEOOUT_x*DSTUDPPORTAUDIO SET xxxxx
MAIN*CONFIGURATION*MATROX*VIDEOOUT_x*REDUNDANCYDSTADDRESSAUDIO SET
xxx.xxx.xxx.xxx
MAIN*CONFIGURATION*MATROX*VIDEOOUT_x*REDUNDANCYDSTUDPPORTAUDIO SET xxxxx
MAIN*CONFIGURATION*MATROX*VIDEOOUT_x*DSTADDRESSANC SET xxx.xxx.xxx.xxx
MAIN*CONFIGURATION*MATROX*VIDEOOUT_x*DSTUDPPORTANC SET xxxxx
MAIN*CONFIGURATION*MATROX*VIDEOOUT_x*REDUNDANCYDSTADDRESSANC SET
xxx.xxx.xxx.xxx
MAIN*CONFIGURATION*MATROX*VIDEOOUT_x*REDUNDANCYDSTUDPPORTANC SET xxxxx

```

## To Change the Source Address of the Input Channels

```

MAIN*CONFIGURATION*CHANNELS*LIVEIN_x*ENABLEDSTATE SET ON/OFF
MAIN*CONFIGURATION*CHANNELS*LIVEIN_x*DSTADDRESS SET xxx.xxx.xxx.xxx
MAIN*CONFIGURATION*CHANNELS*LIVEIN_x*DSTUDPPORT SET xxxxx
MAIN*CONFIGURATION*CHANNELS*LIVEIN_x*REDUNDANCYDSTADDRESS SET xxx.xxx.xxx.xxx
MAIN*CONFIGURATION*CHANNELS*LIVEIN_x*REDUNDANCYDSTUDPPORT SET xxxxx
MAIN*CONFIGURATION*CHANNELS*LIVEIN_x*DSTADDRESSAUDIO SET xxx.xxx.xxx.xxx
MAIN*CONFIGURATION*CHANNELS*LIVEIN_x*DSTUDPPORTAUDIO SET xxxxx
MAIN*CONFIGURATION*CHANNELS*LIVEIN_x*REDUNDANCYDSTADDRESSAUDIO SET
xxx.xxx.xxx.xxx
MAIN*CONFIGURATION*CHANNELS*LIVEIN_x*REDUNDANCYDSTUDPPORTAUDIO SET xxxxx
MAIN*CONFIGURATION*CHANNELS*LIVEIN_x*DSTADDRESSANC SET xxx.xxx.xxx.xxx
MAIN*CONFIGURATION*CHANNELS*LIVEIN_x*DSTUDPPORTANC SET xxxxx
MAIN*CONFIGURATION*CHANNELS*LIVEIN_x*REDUNDANCYDSTADDRESSANC SET
xxx.xxx.xxx.xxx
MAIN*CONFIGURATION*CHANNELS*LIVEIN_x*REDUNDANCYDSTUDPPORTANC SET xxxxx

```

Viz Engine currently supports NMOS IS-04 and NMOS IS-05 protocols for IP enabled IO boards.

## How to Setup X.mio5 Separate Flows

### General Information

Several use cases require the increased flexibility to combine multiple flows and treat them as one entity or channel.

To achieve this we need to specify the definition of a channel (in IP) first. A channel consists of:

- One or two video flows (two flows AKA fill/key are not yet implemented for IP inputs).
- 0..n audio flows containing up to 64 tracks of audio (follow the correct naming here).
- 0..n ancillary data flows (currently only one ancillary data flow is supported).

**Attention:** There are two system wide limitations: the maximum amount of connectors/flows on an X.mio5 Q25 is 200, and the maximum amount of audio tracks across all flows is 2048. An X.mio5 D25 can host 100 flows and 1024 tracks of audio.

Group Hints, which are part of the IP configuration, will be used to create a channel.

**Attention:** Matrox X.mio3 does not support separate flows.

### Configuration

All configuration must be done in the *ipconfig.xml* file, which can be found in *%PROGRAMDATA%\vizrt\VizEngine*.

- *<GroupHint>* entries are used to determine which connectors belong to which channel. The definition always start with one video flow. It is not possible to create an audio only channel.
- Group hints must follow the rules of [BCP-002-01](#), specifically the rules for the [Group Hint Tags](#) detailed in the NMOS parameter registers.
- Key connectors are used automatically when configured. The group hint is ignored in that case.
- Make sure, that the amount of audio flows for inputs and outputs is identical.
- It is necessary to set the *<TrackCount>* per audio flows for both inputs and outputs to be the same.
- Audio track configuration for X.mio5 is done in the *ipconfig.xml* only. Track settings in the Viz Engine configuration file are ignored.

### Known Limitations

- The audio input and output configuration must be identical.
- It is necessary to feed exactly the amount of tracks configured.
- It is highly recommended to use power of two track configurations only (2, 4, 8, 16, 32, 64).

## NMOS Configuration

### General Information

NMOS control is enabled on a driver level. No changes are needed in Viz Engine. NMOS connection requests must be sent out-of-band for X.mio3. For X.mio5, the requests can be either out-of-band or in-band.

- **Out-of-band:** RDS and receiver NIC on the attached machines must be located in a network separated from the essence network, which hosts video, audio and ancillary data flows.
- **In-band:** The RDS can be hosted in the essence network, NMOS requests are sent alongside the essence flows.

**Important:** PTP signals are always in-band.

### Configuration

- Configure Viz Engine as usual.
- Open `%ProgramFiles%\Matrox DSX-TopologyUtils\System64\Axxxxx.json` with any text editor, where `Axxxxx` is the serial number of your installed Matrox IP card.
- Edit the mandatory entries:
  - `enabled` must be set to `true` to enable NMOS functionality.
  - `host name` and `port` in the section `fallback registration server` must point to the RDS (Registration & Discovery Server) for manual configuration.
  - `use service discovery` must be set to `true` for automatic discovery of the RDS.

It is recommended to set the Control IP and port to the values shown in the following example:

**Example:**

```
"enabled": true,
"local host name": "0.0.0.0",
"local port": 8080,
"fallback registration server": {
  "host name": "10.1.1.240",
  "port": 5432,
  "api version": "auto"
},
"use service discovery": true,
"use dns-sd unicast only": false,
"heartbeat interval": 5,
"use secure communication": false,
```

- Edit all the labels, so that they can easily be identified in control applications or NMOS explorers (optional).
- **Save** the file and restart either the machine or `mvNetworkService` from Windows services.



## Special Firewall Rules

In case the a firewall is active on the system, two rules must be added for the NMOS service to run properly:

- If the default Windows firewall is **not** used, UDP port `5353` must be opened for the process `mDNSResponder.exe` for service discovery to work. If the Windows firewall is used, this is done by the driver installer.
- The Matrox NMOS service (`mvNetworkService`) must be accessible. Use the following in an administrator console to add the rule to the Windows firewall:

```
netsh advfirewall firewall add rule name="Matrox NMOS API" protocol=TCP  
dir=in localport={local port} action=allow program="C:\Program Files\Matrox  
DSX-TopologyUtils\System64\mvNetworkService.exe"
```

where `{local port}` is the listening port for the incoming requests as configured in JSON file mentioned above.

## 6.4.2 Matrox Hardware

Viz Engine supports a wide range of Matrox products. This chapter provides an overview of the different Matrox video cards supported by Viz Engine, as well as providing their common installation procedures.

The Matrox X.mio series boards are used as Vizrt's HD, SD and UHD multi-channel video- and audio I/O solution.

- **X.mio5/DSX LE 5 series:** Integrates Viz Engine into an IP based workflow (2110) (optional SDI).
- **DSX Core:** Allows to playback Matrox encoded clips without the need of a physical hardware.
- **X.mio3/DSX LE 4 series:** Introduced in 2015 and is supported by Viz Engine 3.8 and higher.

This section contains information on the following topics:

- [Configuration History for Matrox X.mio and DSX Series](#)
- [Audio Cable Assignment](#)
- [Matrox DSX.Core](#)
- [Matrox M264](#)
- [Matrox X.mio3 12G](#)
- [Matrox X.mio3 - DSX LE 4](#)
- [Matrox X.mio3 IP - DSX LE 4 IP](#)
- [Matrox X.mio5 IP](#)
- [Matrox X.mio5 and DSX LE5 SDI](#)
- [Matrox Driver Installation](#)
- [Troubleshooting Matrox Video Hardware](#)

### See Also:

- [Driver History for Matrox X.mio and DSX Series](#)

## Configuration History for Matrox X.mio and DSX Series

Viz Artist/ Engine Version	Driver	Supported Hardware
5.3	<a href="#">10.4.102.1342</a>	X.mio5 IP, X.mio5 SDI, X.mio3 IP, X.mio3, X.mio3 12G, DSX LE4, DSX LE5 LP, M264
5.2	Topology Utils 10.4.101.1285	X.mio5 IP, X.mio5 SDI, X.mio3 IP, X.mio3, X.mio3 12G, DSX LE4, M264
5.1	Topology Utils 10.3.102.783	X.mio5 IP, X.mio5 SDI, X.mio3 IP, X.mio3, X.mio3 12G, DSX LE4, M264
5.0	Topology Utils 10.3.101.750	X.mio5 IP, X.mio5 SDI, X.mio3 IP, X.mio3, X.mio3 12G, DSX LE4, M264
4.4.0, 4.4.1	Topology Utils 10.2.102.26084	X.mio5 IP, X.mio5 SDI, X.mio3 IP, X.mio3, X.mio3 12G, DSX LE4, M264
4.3.0, 4.3.1	Topology Utils 10.2.100.26040	X.mio5, X.mio3 IP, X.mio3, X.mio3 12G, DSX LE4, M264
4.2.0	Topology Utils 10.1.101.24973	X.mio5, X.mio3 IP, X.mio3, X.mio3 12G, DSX LE4, M264
4.1.0, 3.14.4	Topology Utils 10.1.100.24874	X.mio5, X.mio3 IP, X.mio3, X.mio3 12G, DSX LE4, M264
4.0.0	Topology Utils 10.1.020.24098	X.mio5, X.mio3 IP, X.mio3, X.mio3 12G, DSX LE4, M264
3.14.5	Topology Utils 10.1.102.24988	X.mio5, X.mio3 IP, X.mio3, X.mio3 12G, DSX LE4, M264
3.14.3	DSX.utils/Topology Utils 10.1.060.24670	X.mio5, X.mio3 IP, X.mio3, X.mio3 12G, X.mio2 Plus, X.mio2, DSX LE4, DSX LE3, M264
3.14.1, 3.14.2	DSX.utils 10.1.040.2435 1	X.mio5, X.mio3 IP, X.mio3, X.mio3 12G, X.mio2 Plus, X.mio2, DSX LE4, DSX LE3, M264
3.14.0	DSX.utils 10.1.020.24097	X.mio5, X.mio3 IP, X.mio3, X.mio3 12G, X.mio2 Plus, X.mio2, DSX LE4, DSX LE3, M264

Viz Artist/ Engine Version	Driver	Supported Hardware
3.13.0	DSX.utils 10.0.100.23773	X.mio3 IP, X.mio3, X.mio3 12G, X.mio2 Plus, X.mio2, DSX LE4, DSX LE3, M264
3.12.1	DSX.utils 9.9.1. 23136	X.mio3 IP, X.mio3, X.mio3 12G, X.mio2 Plus, X.mio2, DSX LE4, DSX LE3, M264
3.12.0	DSX.utils 9.9.1. 23136	X.mio3 IP, X.mio3, X.mio3 12G, X.mio2 Plus, X.mio2, DSX LE4, DSX LE3, M264
3.11.1	DSX.utils 9.9.0. 23060	X.mio3 IP, X.mio3, X.mio3 12G, X.mio2 Plus, X.mio2, DSX LE4, DSX LE3, M264
3.11.0	DSX.utils 9.9.0.23060	X.mio3 IP, X.mio3, X.mio2 Plus, X.mio2, DSX LE4, DSX LE3, M264
3.10.0	DSX.utils 9.8.1.22400	X.mio3 IP, X.mio3, X.mio2 Plus, X.mio2, DSX LE4, DSX LE3, DSX LE2/CG
3.9.1	DSX.utils 9.8.1.22400	X.mio3 IP, X.mio3, X.mio2 Plus, X.mio2, DSX LE4, DSX LE3, DSX LE2/CG
3.9.0	DSX.utils 9.8.0.22358	X.mio3 IP, X.mio3, X.mio2 Plus, X.mio2, DSX LE4, DSX LE3, DSX LE2/CG
3.8.3	DSX.utils 9.7.0.21682	X.mio3 IP, X.mio3, X.mio2 Plus, X.mio2, DSX LE4, DSX LE3, DSX LE2/CG
3.8.2	DSX.utils 9.6.0.18841	X.mio3, X.mio2 Plus, X.mio2, DSX LE4, DSX LE3, DSX LE2/CG
3.8.1	DSX.utils 9.6.0.18836	X.mio3, X.mio2 Plus, X.mio2, DSX LE3, DSX LE2/CG
3.8.0	DSX.utils 9.5.0.17766	X.mio3, X.mio2 Plus, X.mio2, DSX LE3, DSX LE2/CG
3.7.0	DSX.utils 9.4.0.9040 (release)	X.mio2 Plus, X.mio2, X.mio, DSX LE3, DSX LE2/CG
3.6.4	DSX.utils 9.2.2.2343	X.mio2 Plus, X.mio2, X.mio, DSX LE3, DSX LE2/CG
3.6.3	DSX.utils 9.2.2.2335 (SP2)	X.mio2 Plus, X.mio2, X.mio, DSX LE3, DSX LE2/CG

<b>Viz Artist/ Engine Version</b>	<b>Driver</b>	<b>Supported Hardware</b>
3.6.2	DSX.utils 9.2.2.2331 (SP2)	X.mio2 Plus, X.mio2, X.mio, DSX LE3, DSX LE2/CG
3.6.0	DSX.utils 9.2.2.2317 (SP2)	X.mio2 Plus, X.mio2, X.mio, DSX LE3, DSX LE2/CG
3.5.3	DSX.utils 7.5.2.1448	X.mio2, X.mio, DSX LE2/CG
3.5.0 - 3.5.2	DSX.utils 7.5.2.447 (SP2)	X.mio2, X.mio, DSX LE2/CG
3.3.0	DSX.utils 7.5.2.443	X.mio2, X.mio
3.2.2	DSX.utils 5.0.3.171	X.mio2, X.mio
3.1.0 - 3.2.1	DSX.utils 5.0.3.166	X.mio2, X.mio

## Audio Cable Assignment

This section contains information on the following topics:

- [AES Input Cable Assignment](#)
- [AES Output Cable Assignment](#)

### AES Input Cable Assignment

Card	Viz Audio Config	AES Cable	Matrox Video Channel
X.mio3	2 tracks	A IN 1/2 A IN 3/4 A IN 5/6 A IN 7/8 B IN 1/2 B IN 3/4 B IN 5/6 B IN 5/6 A IN 1/2+3/4	Video IN A Video IN B Video IN C Video IN D Video IN E Video IN F Video IN G Video IN H Video IN A
	4 tracks	A IN 1/2+3/4 A IN 5/6+7/8 B IN 1/2+3/4 B IN 5/6+7/8	Video IN A Video IN B Video IN C Video IN D
	8 tracks	A IN 1/2+3/4+5/6+7/8 B IN 1/2+3/4+5/6+7/8	Video IN A Video IN B
	16 tracks	A IN 1/2+3/4+5/6+7/8 B IN 1/2+3/4+5/6+7/8	Video IN A

### AES Output Cable Assignment

Card	Viz Audio Config	AES Cable	Matrox Video Channel
X.mio3	2 tracks	A Out 1/2 A Out 3/4 A Out 5/6 A Out 7/8 B Out 1/2 B Out 3/4 B Out 5/6 B Out 7/8	Video Out A Video Out B Video Out C Video Out D Video Out E Video Out F Video Out G Video Out H

Card	Viz Audio Config	AES Cable	Matrox Video Channel
	4 tracks	A Out 1/2+3/4 A Out 5/6+7/8 B Out 1/2+3/4 B Out 5/6+7/8	Video Out A Video Out B Video Out C Video Out D
	8 tracks	A Out 1/2+3/4+5/6+7/8 B Out 1/2+3/4+5/6+7/8	Video Out A Video Out B
	16 tracks	A Out 1/2+3/4+5/6+7/8 B Out 1/2+3/4+5/6+7/8	Video Out A

## Matrox DSX.Core

### Overview

A DSX.Core is a software-only module allowing you to decode and encode clips or Matrox streams. DSX.Core is mainly used in virtual environments. It supports the same codecs as a real hardware board. Since Engine 4.4.1, licensing is done directly via Viz Engine and does not require any additional configuration on Matrox side.

DSX Core requires one of the two licenses:

- DSX Core HD license
- DSX Core UHD license

### To Install DSX.Core

**Note:** Make sure you start the installation with Administrator rights.

- Launch *DSX-TopologyUtils.exe*.
- Be sure to select Matrox DSX Core client:

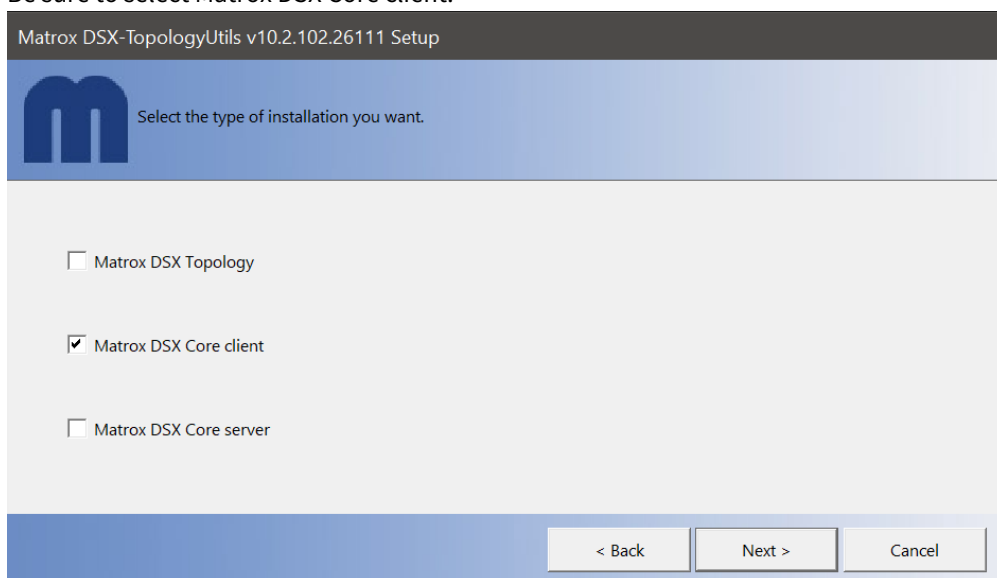

- Be sure to select one of the required licenses within Viz Engine Configuration:

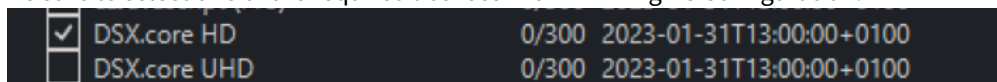

Depending on your setup, you may now use it to play back clips using Matrox codecs, use Matrox Streams or the ClipOut Channel. Further information about DSX.Core is available at [matrox.com](https://matrox.com).

**Note:** Matrox Section and Clip Output are disabled in Configuration mode due to technical reasons.



 **Known Issue:** After the installation of the DSX.Core client version of the driver, perform the following steps:

1. Unregister *mvfDsxCore.dll*.
  - a. Click **Start > Run** (or use the Windows command line: **Search > CMD >** (Right click) **Run as Administrator**).
  - b. Type `REGSVR32 /U "C:\Program Files\Matrox DSX-TopologyUtils\System64\mvfDsxCore.dll"` and press **ENTER**.
2. Shut down *X.info* in the task manager (*mveXinfo.exe*).
3. Delete *mvfDsxCore.dll* from the folder `C:\Program Files\Matrox DSX-TopologyUtils\System64\`.
4. Start *X.info* (*mveXinfo.exe*).

## Matrox M264

Matrox M264 cards feature hardware-based H.264 encoding and decoding capabilities. Depending on the card used, up to four UHD XAVC streams can be encoded/decoded simultaneously. Viz Engine and Channel Recorder are both capable of using the M264 cards for playback and capture of XAVC material, without affecting CPU performance.



### Key Features

- PCI Express Cards
- H.264 video encoding and decoding
- UHD resolution support
- 4:2:2 10-bit
- Sony XAVC compliant encoding including 4K XAVC Long and 4K Intra Class 480
- Panasonic AVC-Ultra compliant

### Performance for 4:2:2 10-bit Streams for M264 (S1)

Resolutions	Structure	Format	Number of streams
2160p	I-frame	XAVC Class 300 & Class 480 / AVC-Intra 4K	1
1080p	I-frame	XAVC Class 200 / AVC-Intra 200	3
1080i	I-frame	XAVC Class 100 / AVC-Intra 100	10
2160p	Long GOP	Generic / XAVC 4K Long	1

<b>1080p</b>	Long GOP	Generic / XAVC Long50 / AVC-LongG50	5
<b>1080i</b>	Long GOP	Generic / XAVC Long25 / AVC-LongG25	10
<b>720p</b>	Long GOP	Generic / XAVC Long25 / AVC-LongG25	10

**Note:** Since the S2, S3 or S4 models host more encoder/decoder chips respectively, the number of possible streams is doubled, tripled or quadrupled.

## M264 Configuration

### Viz Engine

Viz Engine automatically uses all M264 cores available from the installed M264 boards in the system. There is a configuration to be able to choose the cores to be used by a specific Viz Engine instance:

```
## Specify which M264 cores the engine is allowed to use (e.g. 0,1,2). Empty string
means the engine can use all of them. Use any non-numerical string, such as None, to
not use any M264 cores.
#* Matrox.Clip.M264CoresToUse: Default=
# Matrox.Clip.M264CoresToUse =
```

For example, when using dual channel with an M264S4, it might be desirable for the first instance to use a different set of cores than the second instance, so the configuration for the first instance would look like this:

```
Matrox.Clip.M264CoresToUse = 0,1
```

The second instance configuration would look like this: `Matrox.Clip.M264CoresToUse = 2,3`

These configurations mean that the first instance can only use the first and second core, while the second instance can only use the third and the fourth core of the M264S4.

### Channel Recorder

When the XAVC UHD codec is used, Channel Recorder automatically detects any installed M264 card and uses it for encoding. No further configuration is necessary.

## Matrox X.mio3 12G

The Matrox X.mio3 12G video board is targeted for the growing UHD market. It is a half-length, full height PCI Express card that offers two 12G SDI inputs and two 12G SDI outputs, using one input and one output module manufactured by Embrionix. The card is based on the original Matrox X.mio3 design and is capable of handling one input and fill/key output, or two inputs and one fill output.

**✘ Important:** Due to the increased bandwidth of the signal, it is important to use high quality cables and as few connection points as possible. It is not recommended to use converter cables from Mini-BNC to standard BNC.

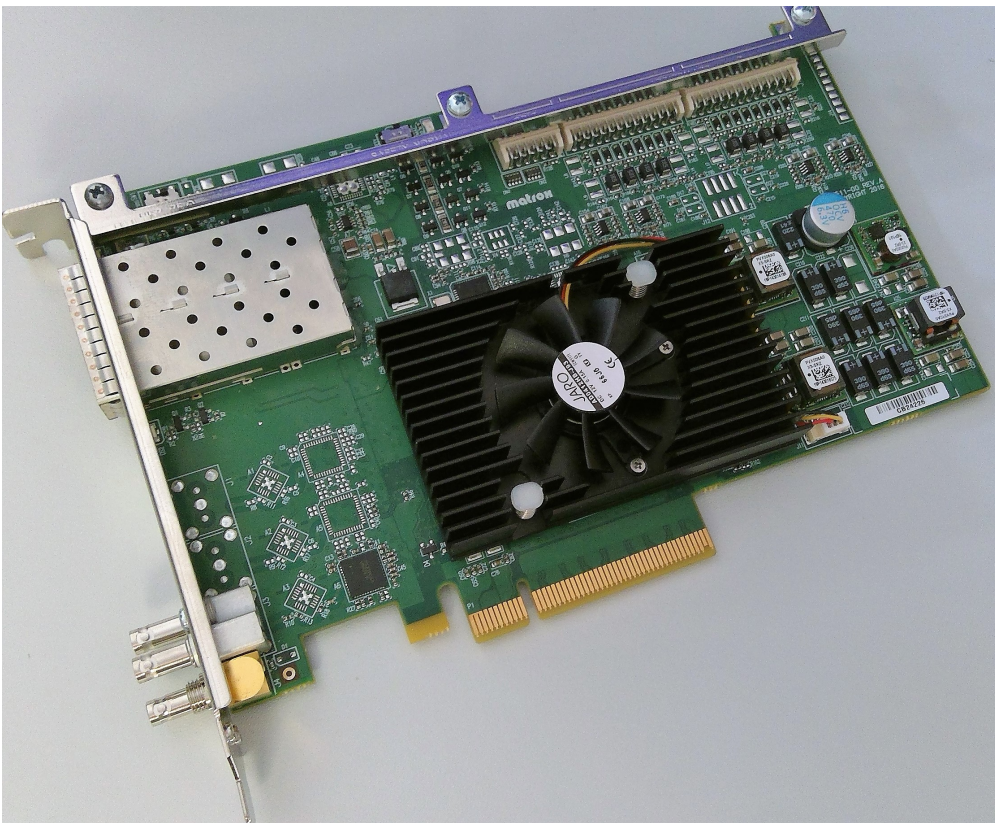

There is one Mini-BNC connector used to connect the card to the house genlock signal. The other two connectors are not implemented.

### Key Features

- Half-length PCI Express card.
- Up to two 12G SDI inputs.
- Up to two 12G SDI outputs.
- Frame synchronizers on each input.
- VANC and HANC support for each input and output.
- Analog blackburst reference input (tri-level or bi-level).
- Onboard 4K scaler.



- Onboard 4K compositor.
- Up to 16 channels of AES/EBU inputs and outputs.

Matrox X.mio3 12G Configuration

The main video properties match those of a Matrox X.mio3, meaning you can have either one UHD input and one Fill/Key UHD output, or two UHD inputs and one Fill UHD output. Please see Matrox Configuration Section for further details.

**X.mio3 12G connections**

	Type of connector	Supported models	Label	Channel
X.mio3 12G	SFP (RX) (12G SDI)	EB12HD2R-MNR-2	B	IN F/ Key E
		EB12LC2R-MN-P		IN E
	SFP (TX) (12G SDI)	EB12HD2T-MNR-2	A	OUT D
		EB12LC2T-SN-13D		OUT C / Key D
HD-BNC (3G SDI)		2	OUT B/ Key A	
HD-BNC (3G SDI)		not supported	1	OUT A

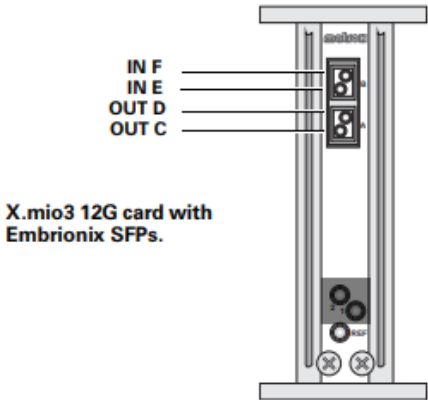

For more information on the supported Embrionix SFP models, see “X.mio3 12G validated SFPs” in the *Matrox X.mio3 Installation Manual*

**Attention:** The HD-BNC connectors labeled 1 and 2 are not supported by Viz Engine.

Embrionix SFP I/O Modules

The needed 12G SFPs are available in two flavors, one for input and one for output. To connect to the SFPs standard Mini-BNC cables can be used.



Matrox X.mio3 12G SFP Configuration

It is important that the seating of SFPs is correct, otherwise inputs and outputs are not available. The output SFP goes into the lower bay and the input SFP into the upper one. See pictures for reference.

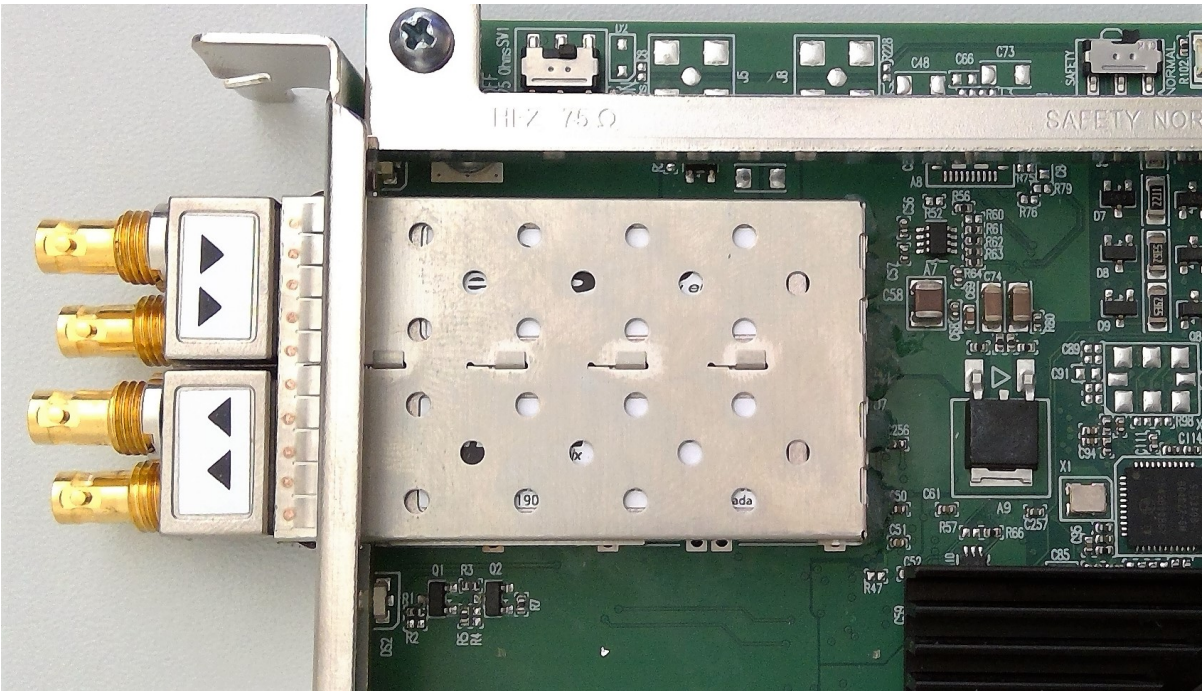
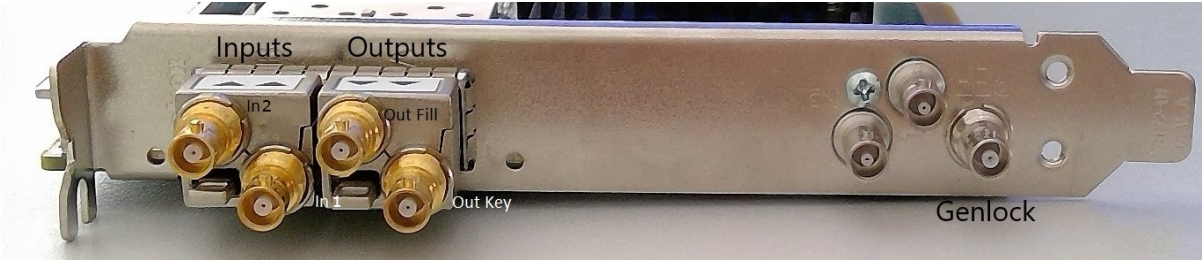

## Matrox X.mio3 - DSX LE 4

This section first gives an overview of the Matrox X.mio3 video cards, then describes the details specific to the full height X.mio3 FH and low profile X.mio3 LP versions of the card. The [Matrox X.mio3 IP - DSX LE 4 IP](#) board is discussed in a separate section.

DSX LE 4 cards have the same capabilities as their X.mio3 counterparts, but lack an onboard video mixer, so DVE is not usable on those boards. Whenever X.mio3 is mentioned in this document, the same is true for DSX.LE 4.

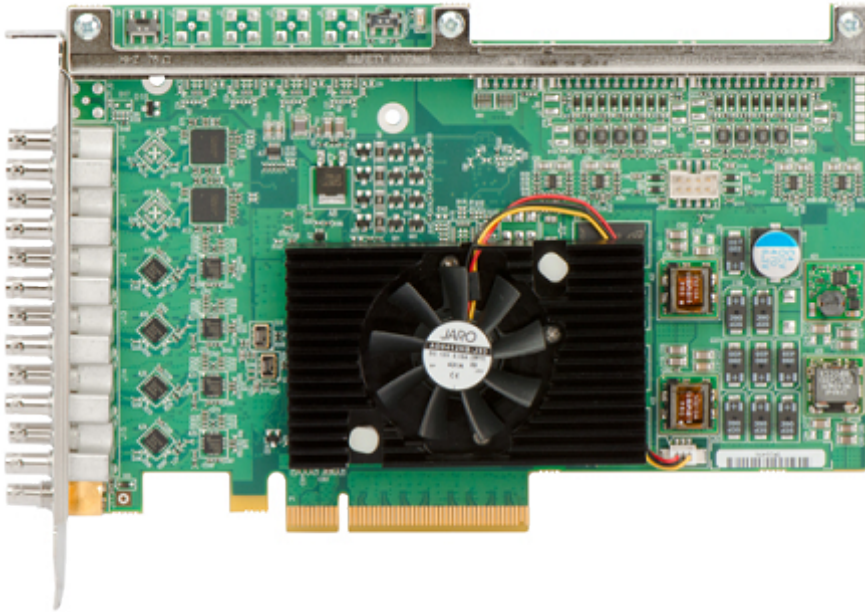

In this section:

- [Matrox X.mio3 Overview](#)
- [X.mio3 FH](#)
  - [Key Features](#)
- [X.mio3 LP](#)
  - [Key Features](#)
- [X.mio3 Connector Mapping Reference](#)
  - [FH X.mio3 X2 Connector Mapping for Quad-Link Inputs](#)
- [X.mio3 I/O Port Configuration](#)
- [Viz Engine Matrox Video Mapping Configuration](#)
- [To Upgrade X.mio Class and Firmware](#)
- [X.mio3 AES Audio Kit](#)
- [Upgrading Matrox Firmware for 2 Sample Interleave](#)

## Matrox X.mio3 Overview

The X.mio3 can be ordered in two configurations: FH (full height, 12 physical HD-BNC connectors, plus one connector for sync) and LP (low profile, eight physical HD-BNC Connectors, plus one connector for sync). Both are half length PCI express Gen2 x8 cards.



- X.mio3FH (Full Height, half length) with up to 12 I/O ports, SD to 4K capable. This card can be ordered with six, eight or X2 (12) I/O. Eight ports are hardwired through relays: Four inputs to four outputs. Model /6 means six I/Os are available, model /8 eight I/Os. Model X2 (twelve ports) has four freely configurable ports. There can be maximum eight I/Os of one type (either in or out) enabled on a card.
- X.mio3LP (Low Profile, half length) with up to eight I/O ports, SD to 4K capable.
- The I/O ports are configurable. This means that for instance the X.mio3 model /8 can be configured to have from 8/0 (for example, 8 channels in, zero channels out) to 0/8 (zero channels in, eight channels out). Only even combinations are allowed.
- One connector is reserved for a reference signal (sync) marked as REF.  
The default card is an X.mio3/6/100, meaning X.mio3 FH with six connectors class 100. The class 100 can not play any video clips and upgrade to class 500 is required to enable both SD and HD clip playback. For Apple ProRes support, the class 550 is needed.

The I/O connectors for the X.mio3 are of the Mini-BNC (also called HD-BNC) type. The use of cable converters from Mini-BNC to BNC may be required.

The X.mio3 cards can be combined with the AES Audio Kit for 16 AES audio channels In/Out, see [X.mio3 AES Audio Kit](#).



## X.mio3 FH

X.mio3 FH provides multichannel SDI IO with hardware based video processing in a full-height, half-length PCI express card with 13 physical HD-BNC connectors. This card provides up to 12 reconfigurable I/Os, from SD to 4K, one connector is reserved for sync. Support for AES/EBU, LTC and GPIO provide for versatile connectivity. The multi-channel hardware processing accelerates compute-intensive operations including motion-adaptive de-interlacing, up/down/cross scaling and mixing/compositing for all resolutions, including 4K.

### Key Features

- Half-length PCI express card
- Re-configurable IO that can support up to 12 SDI IO
- Frame synchronizers
- VANC and HANC support for each input and output
- Analog black burst reference input (tri-level or bi-level)
- On-board multi-channel MADI (Motion Adaptive De-Interlacer)
- On-board multi-channel Up/Down/Cross scaler
- On-board multilayer compositor



- Automatic video relay bypass
- Live zero-frame delay video and audio mixers
- Up to 16 channels of AES/EBU inputs and outputs
- Up to eight LTC inputs and outputs
- RS422 control
- Single slot all inclusive option

**✘ IMPORTANT!** Not all X.mio3 hardware features are supported by Viz Engine. Features available depends on drivers, SDK and Engine versions in use.

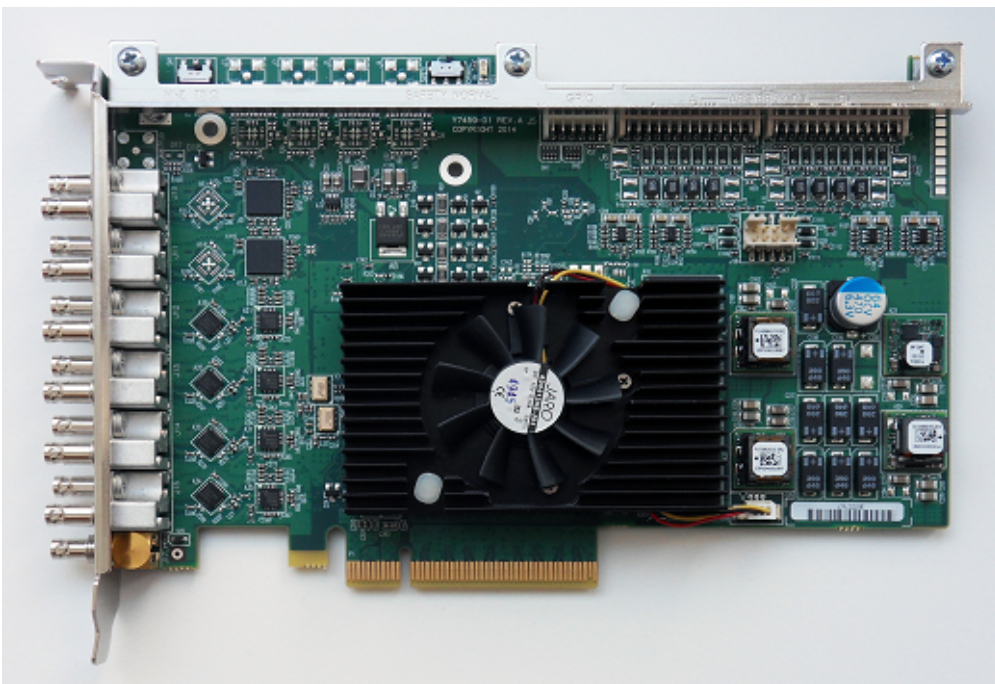

## X.mio3 LP

Matrox X.mio3 LP is a low-profile, half-length PCIe card with up to eight reconfigurable SDI I/Os from SD to 4K.

### Key Features

- Low profile, half-length PCI-e card.
- Re-configurable I/O that can support up to eight SDI inputs or outputs.
- Frame synchronizers.
- VANC and HANC support for each input and output.
- Analog black burst reference input (tri-level or bi-level).
- On-board multi-channel MADI (Motion Adaptive De-Interlacer).
- On-board multi-channel Up/Down/Cross scaler.
- On-board multilayer compositor.
- Automatic video relay bypass (optional).
- Live zero-frame delay video and audio mixer.

**✘ IMPORTANT!** Not all X.mio3 hardware features are supported by Viz Engine. Features available depends on drivers, SDK and Engine versions in use.

The X.mio3 LP models are: /4, /6, /8 - corresponding to the number of I/O port the configuration supports.

## X.mio3 Connector Mapping Reference

This section is a reference for X.mio3 connector mappings.

Upgrades and firmware setup of I/O mapping should be done by Vizrt or a qualified technician.

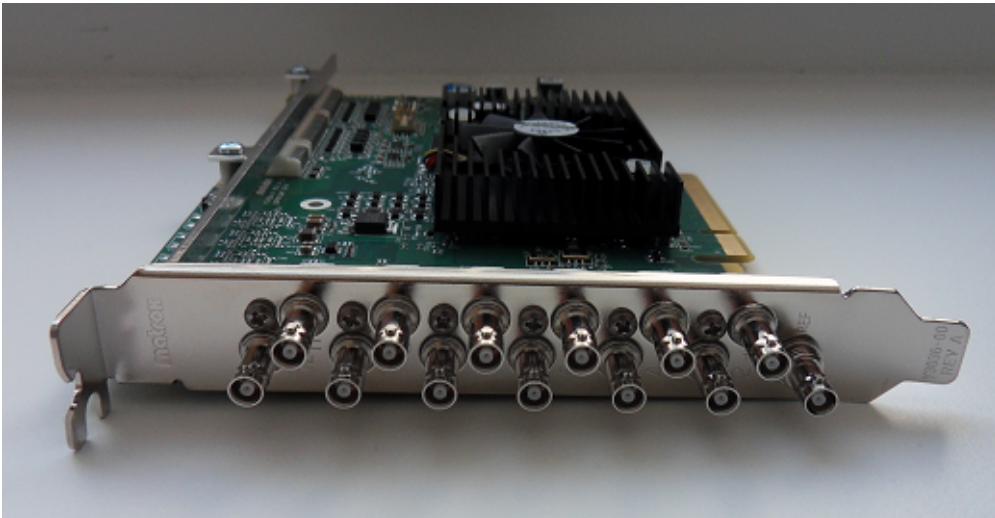

The X.mio3 connectors are labeled 1 through 12 (plus one connector for sync), eight connectors for the LP (low profile) card. As explained, the connectors can be configured for in or out and with various capabilities for clip playback depending on class - with possibilities for firmware class upgrades.

**✘ IMPORTANT!** There can be maximum eight ports of the same type (either in or out), this restriction also applies to the model x2 that has 12 connectors.

Connectors 1,3,5,7 are always reserved for **input**, connectors 2,4,6,8 for **output**. Hence, if the Watchdog is active port 1 (in) goes to port 2 (out) with relay, port 3 (in) to port 4(out) and so on.

The x2 model can as mentioned only have eight I/Os of the same type; 8in - 4out or 4in - 8out.

To configure the X.mio3 card for usage:

- Make sure that the card has the required mix of inputs and outputs required for the intended usage, for instance to satisfy fill, key, full-screen graphics requirements. This is done, if required, with the `mvConnectorConfig.exe` utility described in [X.mio3 I/O Port Configuration](#).
- Map the I/Os from step 1 above to the Viz Video channels using the Viz Engine Configuration utility. This is mostly the same procedure for X.mio3 as for previous Matrox cards, see [Matrox X.mio3 - DSX LE 4#Viz Engine Matrox Video Mapping Configuration](#).

### FH X.mio3 X2 Connector Mapping For Quad-Link Inputs

The following table lists the connectors used for quad-link inputs, depending on the I/O port mapping of the card. This has been tested on X.mio3 X2 and approved by QA. It may differ from card to card. Viz Engine does not support fill+key for quad-link inputs and the mapping between Engine input channels and ports is hard-coded.

FPGA configuration	Mapping	Input	Connectors used (Matrox Terminology)	Connectors used (Viz Terminology)
2SI	4in/8out	1	A-C-E-G	1-3-5-7
	8in/4out	1	A-C-I-J	1-3-9-10
		2	E-G-K-L	5-7-11-12
Square Division (SD) & 2SI Alternate	4in/8out	1	A-C-E-G	1-3-5-7
	8in/4out	1	A-C-E-G	1-3-5-7
		2	I-J-K-L	9-10-11-12

### X.mio3 I/O Port Configuration

Normally the I/O ports are pre-configured when delivered from Vizrt. If the I/O configuration needs to be changed, the Matrox command-line utility `mvConnectorConfig.exe` normally found in:

```
C:\Program Files\Matrox DSX-TopologyUtils\drivers\mvConnectorConfig.exe
```

must be used. `mvConnectorConfig.exe` can be called from the command prompt without options to get a helpful usage message. To configure all X.mio3 cards in a system to use four inputs and two outputs the syntax is:

```
C:\Program Files\Matrox DSX-TopologyUtils\drivers\mvConnectorConfig.exe -4in2out
```

To configure six outputs and no inputs the syntax is:

```
C:\Program Files\Matrox DSX-TopologyUtils\drivers\mvConnectorConfig.exe -0in6out
```

and so on for the various I/O possibilities.

The computer should be stable with low load and no Viz programs running when using the configuration utility. Never interrupt a firmware upgrade. After making changes to the Matrox I/O configuration, the computer must be re-started with a complete power off.

 **Note:** For X.mio3/X2 cards, only 4/8 and 8/4 are supported. Please check the connector mapping document for more information.

## Viz Engine Matrox Video Mapping Configuration

Open **Viz Configuration > Matrox** to configure the Matrox video channel mapping and mapping type.

The Viz video inputs are named alphabetically and limited to the number of available I/O channels the system has. The number in parenthesis indicates which channel is being used for fill and key. If you do not need a key signal in the output, de-select the **Key > Contains Alpha** option to make the I/O channel available for other usages. Example configuration:

Channel	Type
Settings for Live Input Channel	SDI
Live Channel 2	SDI
Live Channel 3	Inactive
Live Channel 4	Inactive
Live Channel 5	Inactive
Live Channel 6	Inactive
Live Channel 7	Inactive
Live Channel 8	Inactive
Live Channel 9	Inactive
Live Channel 10	Inactive
Live Channel 11	Inactive
Live Channel 12	Inactive
Live Channel 13	Inactive
Live Channel 14	Inactive
Live Channel 15	Inactive
Live Channel 16	Inactive
Live Channel 17	Inactive
Live Channel 18	Inactive
Live Channel 19	Inactive
Live Channel 20	Inactive
Live Channel 21	Inactive
Live Channel 22	Inactive
Live Channel 23	Inactive
Live Channel 24	Inactive
Live Channel 25	Inactive
Live Channel 26	Inactive
Live Channel 27	Inactive
Live Channel 28	Inactive
Live Channel 29	Inactive
Live Channel 30	Inactive
Live Channel 31	SHM - SMURF
Live Channel 32	SHM - SMURF

**Video System** HD - 1080p

**Colorimetry** Rec. 2100 - HLG

**Bits Per Channel** 10

**Video Settings**

- Contains Alpha
- Delay DVE 1
- Delay Texture 1

**Audio Settings**

- Enable Audio
- Audio Channels 2 Channels
- Delay DVE 4
- Delay Texture 4

**Vbi Settings**

- Enable VBI
- Delay DVE 4
- Delay Texture 4

**Source Connector** SDI IN E / SDI IN F

**Connector Settings**

- 3G Level B
- Allow Super Black
- Allow Super White
- Chroma Clipping

**Key Settings**

- Apply Offset
- Invert Luma
- Upscale Luma

Navigate to **Config > Matrox > Video Out** for an overview showing which I/O channels are used for fill and key:

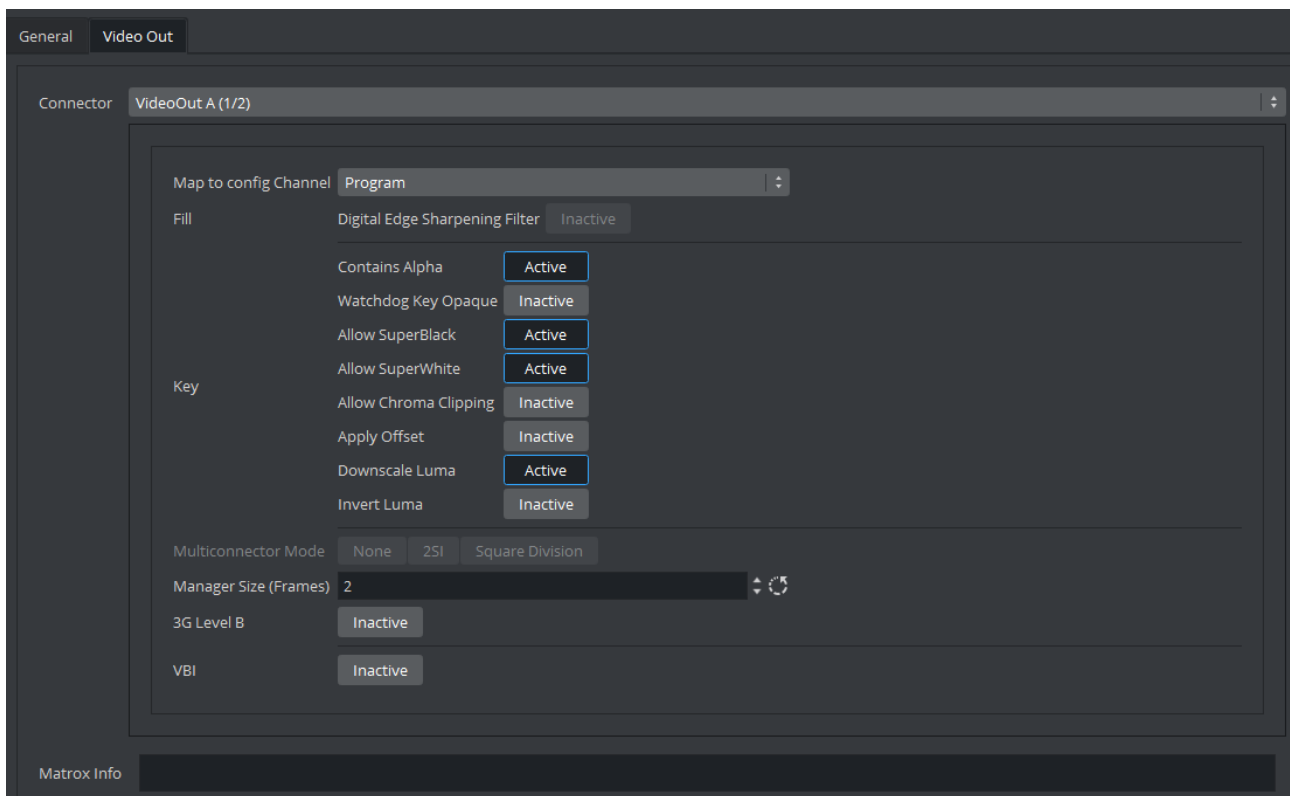

## To Upgrade X.mio Class and Firmware

To upgrade your X.mio3 card, for example to enable more IO-ports or a codec upgrade for HD-Clipback, you must use the *mvDongleUpdater.exe* update utility with your Vizrt supplied license upgrade file *<filename>.OPT*. This utility is installed with the Matrox driver package and is normally installed to:

```
C:\Program Files\Programs\Matrox DSK.utils\drivers\mvDongleUpdater.exe
```

To upgrade the card use this syntax:

```
C:\Program Files\Matrox DSX.utils\drivers\mvDongleUpdater.exe upgrade
-sn="SerialNumberofthecard" -f="Path to the upgrade file"
```

The command above must be run from a Windows command line window (**WINDOWS BUTTON > cmd > ENTER**).

The Matrox [X.info](#) utility is used to display information about the card class, how the Input and Outputs are configured, serial number and more. This utility can normally be started from the Windows taskbar. A typical information window would be:

X.mio3 AES Audio Kit

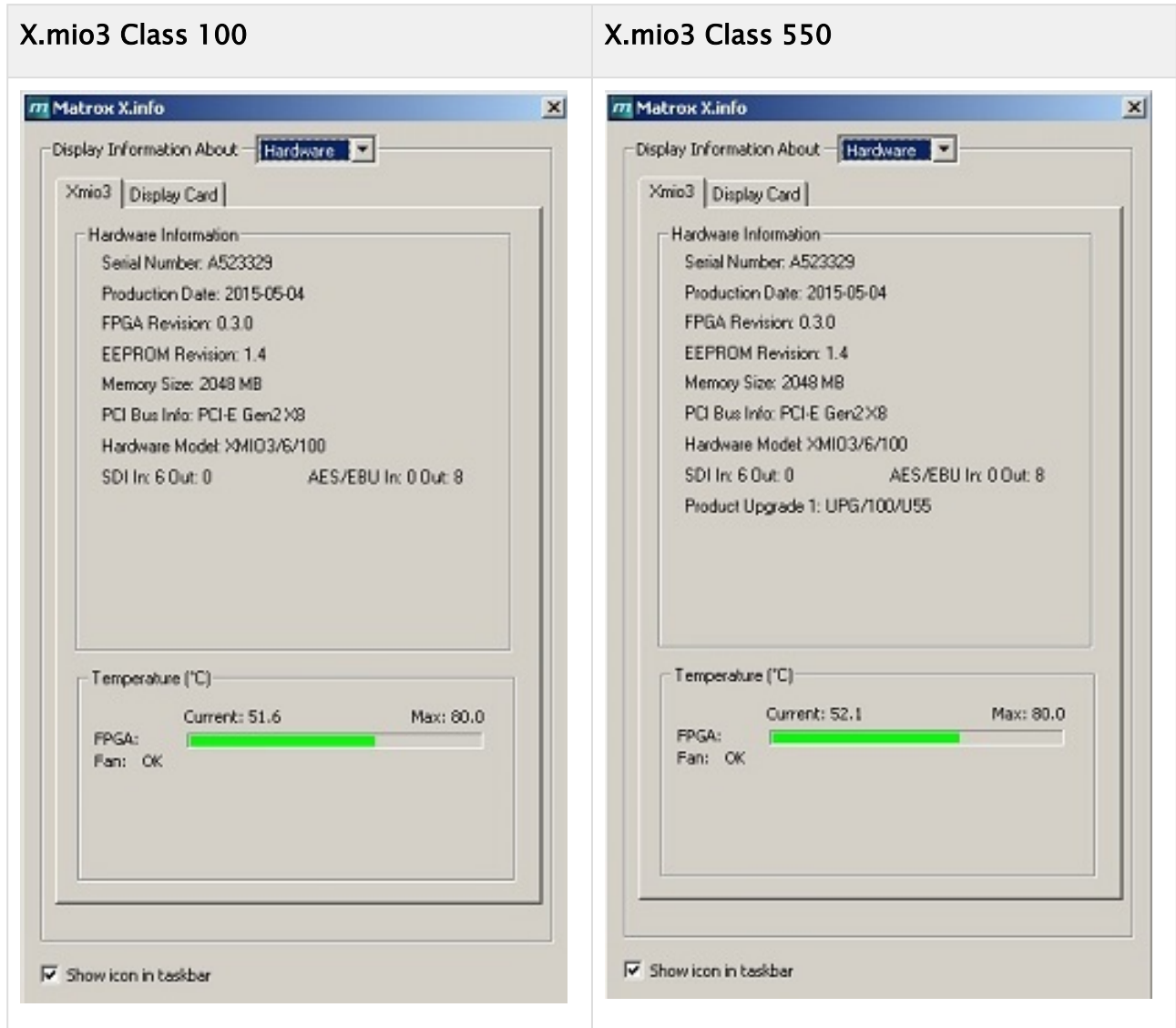

The X.mio3 AES Audio Kit connects to the X.mio3 card internally and takes up one slot as indicated in the picture below:



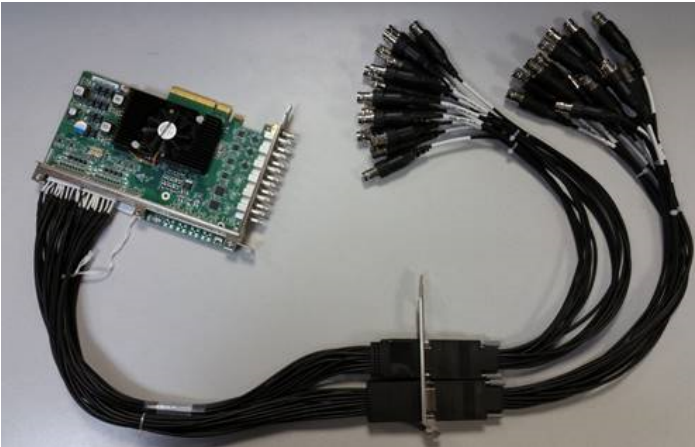

The kit contains:

- Two internal cables with bracket.
- Two external cables, each cable has:
  - Eight AES/EBU in and eight AES/EBU out (total 16 AES/EBU in and out).
  - Four LTC in and four LTC out (total eight LTC in and out).

## Upgrading Matrox Firmware for 2 Sample Interleave

To make your card capable of 2 SI UHD:

- Check if you have an X.mio3 X2 series SDI card.
- Flash the firmware. Open a command line and run the following command:

```
cd C:\Program Files\Matrox DSX.utils\drivers  
mvConnectorConfig.exe -2SI=on
```

- Restart the machine.
- Check *X.Info*, which should state that the card is now in 2SI mode.



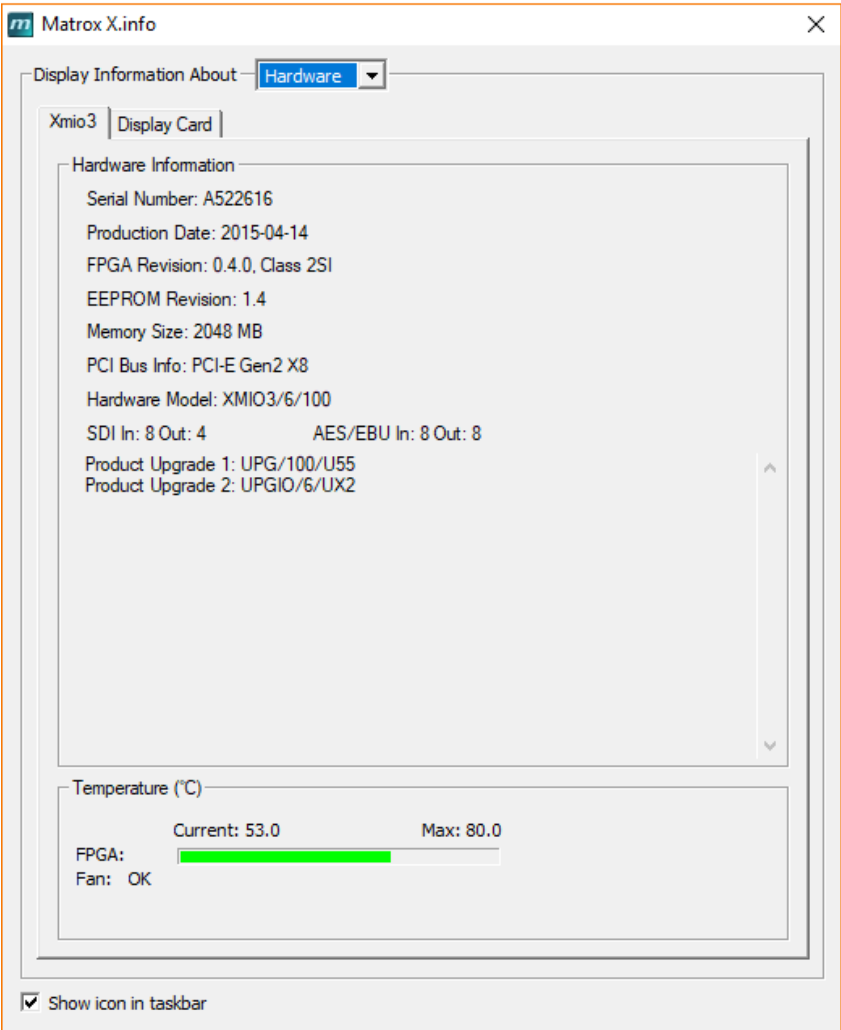

Refer to the connector mapping in the section above for 2SI, 2SI alternate connector mapping.

## Matrox X.mio3 IP - DSX LE 4 IP

The Matrox X.mio3 IP video board was designed to help broadcast equipment manufacturers meet the challenges of the SDI to IP transition. It is a half-height, half-length PCIe card that offers multi-channel video I/O over 10 GbE with IP encapsulation of HD and 3G video. The card offers a total of four IP inputs and four IP outputs. The stream content conforms to the SMPTE ST 2110 specification. SMPTE ST 2022-7 is supported in both modes.

DSX LE 4 IP cards have the same capabilities as their X.mio3 counterparts, but lack an onboard video mixer, so DVE is not usable on those boards. Whenever X.mio3 IP is mentioned in this document, the same is true for DSX LE 4 IP.

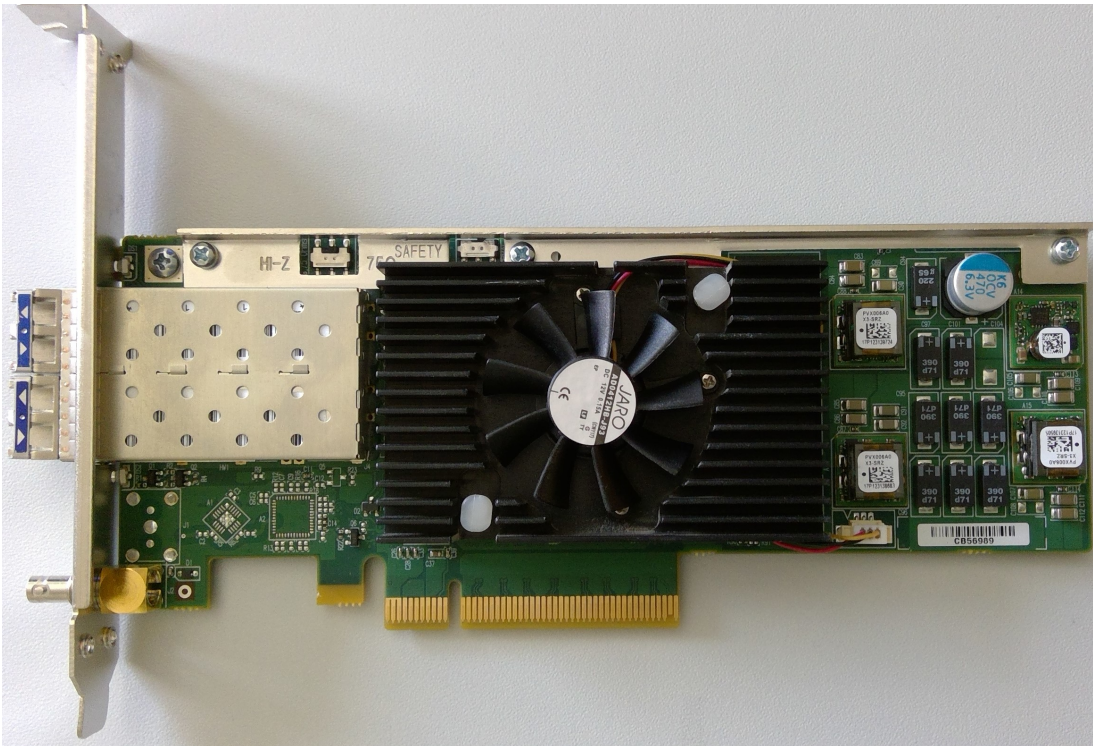

The card contains two enhanced small form-factor pluggable (SFP+) slots, or "bays". In the lower bay is **SFP A**, and hosts input and output channels 1 through 4. The upper bay houses **SFP B**, which hosts all of the redundant channels used with SMPTE ST 2022-7. The board does not have any SDI inputs or outputs. There is one Mini-BNC connector used to connect the card to the house genlock signal. However, the card can also be locked to a SMPTE ST 2059 conform time signal, sent via the SFPs.

Be aware that SFPs come in two flavors:

- Short range (SR, 850 nm), and
- Long range (LR, 1310 nm).

In general, a cable may only connect two SFPs of the same type. In addition, please be aware that the SFP should not be constantly switched in and out of the X.mio3 IP card, as the warranty on the card may be voided if this occurs more than 40 times.

## Key Features

- Dual SFP+ cages for a total of four video inputs and four video outputs.
- IP (SMPTE ST 2059 PTP) and analog blackburst timing reference.

- X.mio3 IP and DSX LE 4 are narrow senders as per SMPTE ST 2110-21.
- Both cards are narrow receivers as per SMPTE ST 2110-21, and thus can only receive narrow flows.
- Onboard multi-channel Up/Down/Cross scaler.
- Onboard multi-layer compositor.

### Matrox X.mio3 IP Configuration And IP Properties

The main video properties of the IP input channels are very similar to live input channels on a Matrox card. These properties are accessible in the [Video Input Live Input](#) section of Viz Configuration.

### Fill and Key Channel Mapping

When an output channel uses the alpha channel, a key channel is created. This is always the next numbered output channel:

- Fill is on output 1, and key is on output 2.
- Fill is on output 3, and key is on output 4.

 **Note:** It is possible for a dual channel setup to use independent output channels on one SFP, for example 1 and 2. In this case, the **Use alpha** property must be disabled for both channels.

### Default IP Properties

The default IP configuration is meant to serve as placeholder only. It is required to change those default values to match your internal IP landscape. All IP related settings were moved to a separate configuration file. To get the file, Viz Engine must be started at least once. After that, the configuration can be changed using the commands mentioned below, or by editing the file *ipconfig.xml*, located in the *ProgramData* directory of Viz Engine. The manual step is necessary for all settings not linked to a command. Please refer to the section below for further information.

### Configuration Settings

The configuration of the IP settings was moved to an XML file containing IP relevant parameters only.

 **Note:** When editing the XML file, do not delete any tags and only edit values between `<tag>` and `</tag>`.

### SFP Settings

Setting	Description
IPv4Address	Indicates the static IPv4 address.
IPV4Gateway	Indicates the IPv4 Gateway.
IPv4Netmask	Indicates the IPv4 Netmask.

Setting	Description
Smpte2059SfpSettings::TypeOfServiceDSCP	Indicates that the Type of Service (ToS) is Differentiated Service Code Point (DSCP). Range is [0..63] (6 bits).
Smpte2059SfpSettings::DelayMechanism	Indicates the type of delay mechanism to use for the time server connection. 0 = Invalid 1 = EndToEnd 2 = PeerToPeer
Smpte2059SfpSettings::IpMode	Indicates the type of internet protocol mode to use for the time server connection. 0 = Invalid 1 = Multicast 2 = Unicast 3 = Hybrid
Smpte2059SfpSettings::MasterClockDomainNumber	Indicates the time server clock domain number to use.
Smpte2059SfpSettings::JoinType	Indicates the type of membership request made. 0 = Invalid 1 = None 2 = IGMPv2 3 = IGMPv3
Smpte2059SfpSettings::IgmPV3Settings::FilterType	Only needed when the join type is set to 3 = IGMPv3. Indicates the filter type applied. 0 = Invalid 1 = Inclusion 2 = Exclusion
Smpte2059SfpSettings::IgmPV3Settings::FilterListCount	Indicates the number of IPv4 source addresses in the filter list. Maximum is four.
Smpte2059SfpSettings::IgmPV3Settings::FilterList	Indicates the list of IPv4 source addresses to filter separated by commas.

## General Output Settings for SMPTE ST 2110

Setting	Description
Redundancy	If set to true, enables the redundant stream for seamless reconstruction conforming to SMPTE ST 2022-7.

## Video Output Settings for SMPTE ST 2110

Setting	Description
RtpPayloadId	For SMPTE ST 2110 only: Indicates the RTP (Real-time Transfer Protocol) payload ID.
TimeToLive	Indicates the time in which packets can be used in seconds. That is, it indicates the packets' Time to live (TTL).
TypeOfServiceDSCP	Indicates that the Type of Service (ToS) is Differentiated Service Code Point (DSCP). Range is [0..63] (6 bits).
TypeOfServiceECN	Indicates that the Type of Service (ToS) is Explicit Congestion Notification (ECN). Range is [0..3] (2 bits).
Primary::SrcUdpPort	Indicates the User Datagram Protocol (UDP) port of the sender (that is, transmitter).
Primary::DstAddress	Indicates the IPv4 address of the destination (that is, receiver). Only used in multicast.
Primary::DstUdpPort	Indicates the UDP port of the destination (that is, receiver).
Secondary::SrcUdpPort	Indicates the redundant stream UDP port of the sender (that is, transmitter).
Secondary::DstAddress	Indicates the redundant stream IPv4 address of the destination (that is, receiver). Only used in multicast.
Secondary::DstUdpPort	Indicates the redundant stream UDP port of the destination (that is, receiver).

## Audio Output Settings for SMPTE ST 2110 only

Setting	Description
RtpPayloadId	Indicates the RTP (Real-time Transfer Protocol) payload ID.
TimeToLive	Indicates the time in which packets can be used in seconds. That is, it indicates the packets' Time to live (TTL).

Setting	Description
TypeOfServiceDSCP	Indicates that the Type of Service (ToS) is Differentiated Service Code Point (DSCP). Range is [0..63] (6 bits).
TypeOfServiceECN	Indicates that the Type of Service (ToS) is Explicit Congestion Notification (ECN). Range is [0..3] (2 bits).
AudioPacketDuration	Indicates the outgoing audio packet duration. 1 = 125 $\mu$ s 4 = 1 ms All other values are not supported.
Primary::SrcUdpPort	Indicates the User Datagram Protocol (UDP) port of the sender (that is, transmitter).
Primary::DstAddress	Indicates the IPv4 address of the destination (that is, receiver). Only used in multicast.
Primary::DstUdpPort	Indicates the UDP port of the destination (that is, receiver).
Secondary::SrcUdpPort	Indicates the redundant stream UDP port of the sender (that is, transmitter).
Secondary::DstAddress	Indicates the redundant stream IPv4 address of the destination (that is, receiver). Only used in multicast.
Secondary::DstUdpPort	Indicates the redundant stream UDP port of the destination (that is, receiver).

## Ancillary Data Output Settings for SMPTE ST 2110 only

Setting	Description
RtpPayloadId	Indicates the RTP (Real-time Transfer Protocol) payload ID.
TimeToLive	Indicates the time in which packets can be used in seconds. That is, it indicates the packets' Time to live (TTL).
TypeOfServiceDSCP	Indicates that the Type of Service (ToS) is Differentiated Service Code Point (DSCP). Range is [0..63] (6 bits).

Setting	Description
TypeOfServiceECN	Indicates that the Type of Service (ToS) is Explicit Congestion Notification (ECN). Range is [0..3] (2 bits).
SMPTE352Payload	If set to 1, enables SMPTE 352 packets.
Primary::SrcUdpPort	Indicates the User Datagram Protocol (UDP) port of the sender (that is, transmitter).
Primary::DstAddress	Indicates the IPv4 address of the destination (that is, receiver). Only used in multicast.
Primary::DstUdpPort	Indicates the UDP port of the destination (that is, receiver).
Secondary::SrcUdpPort	Indicates the redundant stream UDP port of the sender (that is, transmitter).
Secondary::DstAddress	Indicates the redundant stream IPv4 address of the destination (that is, receiver). Only used in multicast.
Secondary::DstUdpPort	Indicates the redundant stream UDP port of the destination (that is, receiver).

## General Input Settings for SMPTE ST 2110

Setting	Description
Redundancy	If set to true, enables the redundant stream for seamless reconstruction conforming to SMPTE ST 2022-7.
JoinType	Indicates the type of membership request made. 0 = Invalid 1 = None 2 = IGMPv2 3 = IGMPv3

## Video Input Settings for SMPTE ST 2110

Setting	Description
RtpPayloadId	For SMPTE ST 2110 only: Indicates the RTP (Real-time Transfer Protocol) payload ID.

Setting	Description
Primary::DstAddress	Indicates the reception multicast IPv4 address.
Primary::DstUdpPort	Indicates the reception User Datagram Protocol (UDP) port.
Primary::PacketIntervalThreshold	Indicates the threshold for generating the time interval between the IP packets alarm on the video flow. The range is from 6.4 ns to 419424.0 ns in intervals of 6.4 ns.
Primary::IgmPV3Settings::FilterType	Only needed when the join type is set to 3 = IGMPv3. Indicates the filter type applied. 0 = Invalid 1 = Inclusion 2 = Exclusion
Primary::IgmPV3Settings::FilterListCount	Indicates the number of IPv4 source addresses in the filter list. Maximum is four.
Primary::IgmPV3Settings::FilterList	Indicates the list of IPv4 source addresses to filter separated by commas.
Secondary::DstAddress	Indicates the redundant stream reception multicast IPv4 address.
Secondary::DstUdpPort	Indicates the redundant stream reception UDP port.
Secondary::PacketIntervalThreshold	Indicates the threshold for generating the time interval between the IP packets alarm on the video flow. The range is from 6.4 ns to 419424.0 ns in intervals of 6.4 ns.
Secondary::IgmPV3Settings::FilterType	Only needed when the join type is set to 3 = IGMPv3. Indicates the filter type applied. 0 = Invalid 1 = Inclusion 2 = Exclusion
Secondary::IgmPV3Settings::FilterListCount	Indicates the number of IPv4 source addresses in the filter list. Maximum is four.



Setting	Description
Secondary::IcmpV3Settings::FilterList	Indicates the list of IPv4 source addresses to filter separated by commas.

## Audio Output Settings for SMPTE ST 2110 only

Setting	Description
RtpPayloadId	For SMPTE ST 2110 only: Indicates the RTP (Real-time Transfer Protocol) payload ID.
AudioPacketDuration	Indicates the outgoing audio packet duration. 1 = 125 $\mu$ s 4 = 1 ms All other values are not supported.
Primary::DstAddress	Indicates the reception multicast IPv4 address.
Primary::DstUdpPort	Indicates the reception User Datagram Protocol (UDP) port.
Primary::PacketIntervalThreshold	Indicates the threshold for generating the time interval between the IP packets alarm on the audio flow. The range is from 102.4 ns to 6710681.6 ns in intervals of 102.4 ns.
Primary::IcmpV3Settings::FilterType	Only needed when the join type is set to 3 = IGMPv3. Indicates the filter type applied. 0 = Invalid 1 = Inclusion 2 = Exclusion
Primary::IcmpV3Settings::FilterListCount	Indicates the number of IPv4 source addresses in the filter list. Maximum is four.
Primary::IcmpV3Settings::FilterList	Indicates the list of IPv4 source addresses to filter separated by commas.
Secondary::DstAddress	Indicates the redundant stream reception multicast IPv4 address.
Secondary::DstUdpPort	Indicates the redundant stream reception UDP port.

Setting	Description
Secondary::PacketIntervalThreshold	Indicates the threshold for generating the time interval between the IP packets alarm on the audio flow. The range is from 102.4 ns to 6710681.6 ns in intervals of 102.4 ns.
Secondary::IcmpV3Settings::FilterType	Only needed when the join type is set to 3 = IGMPv3. Indicates the filter type applied. 0 = Invalid 1 = Inclusion 2 = Exclusion

## Ancillary Data Output Settings for SMPTE ST 2110 only

Setting	Description
RtpPayloadId	For SMPTE ST 2110 only: Indicates the RTP (Real-time Transfer Protocol) payload ID.
Primary::DstAddress	Indicates the reception multicast IPv4 address.
Primary::DstUdpPort	Indicates the reception User Datagram Protocol (UDP) port.
Primary::PacketIntervalThreshold	Indicates the threshold for generating the time interval between the IP packets alarm on the ancillary data flow. The range is from 819.2 ns to 53685452.8 ns in intervals of 819.2 ns.
Primary::IcmpV3Settings::FilterType	Only needed when the join type is set to 3 = IGMPv3. Indicates the filter type applied. 0 = Invalid 1 = Inclusion 2 = Exclusion
Primary::IcmpV3Settings::FilterListCount	Indicates the number of IPv4 source addresses in the filter list. Maximum is four.
Primary::IcmpV3Settings::FilterList	Indicates the list of IPv4 source addresses to filter separated by commas.
Secondary::DstAddress	Indicates the redundant stream reception multicast IPv4 address.
Secondary::DstUdpPort	Indicates the redundant stream reception UDP port.

Setting	Description
Secondary::PacketIntervalThreshold	Indicates the threshold for generating the time interval between the IP packets alarm on the ancillary data flow.  The range is from 819.2 ns to 53685452.8 ns in intervals of 819.2 ns.
Secondary::IcmpV3Settings::FilterType	Only needed when the join type is set to 3 = IGMPv3. Indicates the filter type applied. 0 = Invalid 1 = Inclusion 2 = Exclusion

### Change IP Properties

Although the IP properties may be changed by editing the configuration file directly, the IP address and port numbers can also be set via the command line interface. Because channel numbering is zero-based here, **Output Channel 1** is referred to as `VIDEOOUT_0`. To check the currently configured values call the command using GET (instead of SET) without parameters.

### To Change/Check The Destination Address And Port Of The Output Channels

```

MAIN*CONFIGURATION*MATROX*VIDEOOUT_x*DSTADDRESS SET xxx.xxx.xxx.xxx
MAIN*CONFIGURATION*MATROX*VIDEOOUT_x*DSTUDPPORT SET xxxxx

MAIN*CONFIGURATION*MATROX*VIDEOOUT_x*REDUNDANCYDSTADDRESS SET xxx.xxx.xxx.xxx
MAIN*CONFIGURATION*MATROX*VIDEOOUT_x*REDUNDANCYDSTUDPPORT SET xxxxx

MAIN*CONFIGURATION*MATROX*VIDEOOUT_x*DSTADDRESSAUDIO SET xxx.xxx.xxx.xxx
MAIN*CONFIGURATION*MATROX*VIDEOOUT_x*DSTUDPPORTAUDIO SET xxxxx

MAIN*CONFIGURATION*MATROX*VIDEOOUT_x*REDUNDANCYDSTADDRESSAUDIO SET xxx.xxx.xxx.xxx
MAIN*CONFIGURATION*MATROX*VIDEOOUT_x*REDUNDANCYDSTUDPPORTAUDIO SET xxxxx

MAIN*CONFIGURATION*MATROX*VIDEOOUT_x*DSTADDRESSANC SET xxx.xxx.xxx.xxx
MAIN*CONFIGURATION*MATROX*VIDEOOUT_x*DSTUDPPORTANC SET xxxxx

MAIN*CONFIGURATION*MATROX*VIDEOOUT_x*REDUNDANCYDSTADDRESSANC SET xxx.xxx.xxx.xxx
MAIN*CONFIGURATION*MATROX*VIDEOOUT_x*REDUNDANCYDSTUDPPORTANC SET xxxxx
    
```

### To Change The Source Address Of The Input Channels

```

MAIN*CONFIGURATION*CHANNELS*LIVEIN_x*DSTADDRESS SET xxx.xxx.xxx.xxx
MAIN*CONFIGURATION*CHANNELS*LIVEIN_x*DSTUDPPORT SET xxxxx

MAIN*CONFIGURATION*CHANNELS*LIVEIN_x*REDUNDANCYDSTADDRESS SET xxx.xxx.xxx.xxx
    
```

```

MAIN*CONFIGURATION*CHANNELS*LIVEIN_x*REDUNDANCYDSTUDPPORT SET xxxxx

MAIN*CONFIGURATION*CHANNELS*LIVEIN_x*DSTADDRESSAUDIO SET xxx.xxx.xxx.xxx
MAIN*CONFIGURATION*CHANNELS*LIVEIN_x*DSTUDPPORTAUDIO SET xxxxx

MAIN*CONFIGURATION*CHANNELS*LIVEIN_x*REDUNDANCYDSTADDRESSAUDIO SET xxx.xxx.xxx.xxx
MAIN*CONFIGURATION*CHANNELS*LIVEIN_x*REDUNDANCYDSTUDPPORTAUDIO SET xxxxx

MAIN*CONFIGURATION*CHANNELS*LIVEIN_x*DSTADDRESSANC SET xxx.xxx.xxx.xxx
MAIN*CONFIGURATION*CHANNELS*LIVEIN_x*DSTUDPPORTANC SET xxxxx

MAIN*CONFIGURATION*CHANNELS*LIVEIN_x*REDUNDANCYDSTADDRESSANC SET xxx.xxx.xxx.xxx
MAIN*CONFIGURATION*CHANNELS*LIVEIN_x*REDUNDANCYDSTUDPPORTANC SET xxxxx

```

## X.mio3 IP Command Examples

Set the source address of input channel 4. Because channel numbering is zero-based here, **IP Input Channel 4** is referred to as `LIVEIN_3`.

```

MAIN*CONFIGURATION*CHANNELS*LIVEIN_3*DSTADDRESS SET 224.10.10.34

```

Set the source UDP port of input channel 4:

```

MAIN*CONFIGURATION*CHANNELS*LIVEIN_3*DSTUDPPORT SET 9004

```

Query the destination properties of output 1, fill:

```

> MAIN*CONFIGURATION*MATROX*VIDEOOUT_0*DSTADDRESS GET
< 224.10.10.102
> MAIN*CONFIGURATION*MATROX*VIDEOOUT_0*DSTUDPPORT GET
< 20000

```

Query the destination properties of the key channel associated with output 1:

```

> MAIN*CONFIGURATION*MATROX*VIDEOOUT_1*DSTADDRESS GET
< 224.10.10.104
> MAIN*CONFIGURATION*MATROX*VIDEOOUT_1*DSTUDPPORT GET
< 20000

```

## Matrox X.mio5 IP

The Matrox X.mio5 video board is the next generation IP card supporting SMPTE ST 2110-20/30/40 protocols. It is equipped with quad 25GbE SFPs delivering an effective, fully redundant bandwidth of 50GbE capable of providing four UHD inputs and outputs.



## Key Features

- Native SMPTE ST 2110 support with no CPU usage.
- Up to four UHDp60/50 inputs and four UHDp60/50 outputs over 25GbE.
- ST 2110-21 packet pacing in hardware for narrow senders (Type N).
- Wide asynchronous receivers (Type A).
- 32x HD inputs and outputs over 25GbE.
- 256 audio flows from one to 64 tracks.
- Multi-channel HDR conversion.
- On-board de-interlacing, scaling and compositing.
- Integrated hardware PTP for ST 2059-2.
- Built in NMOS IS-04 and IS-05 support.

## General Notes

- Please be aware that an X.mio5 uses a **16x PCIe** slot. It can't use the same slot as an X.mio3.
- To make sure the PTP is stable, all Power Management options in Windows and BIOS need to be **disabled** (*Runtime power management* disabled in BIOS settings).
- Each SFP of an X.mio5 board requires two IP addresses. This is mandatory.
- NTSC and PAL resolutions are not supported by the SMPTE ST 2110 standard.

## Matrox X.mio5 IP Configuration

Please see section [SMPTE ST 2110 Configuration](#) for further details.

## Matrox X.mio5 and DSX LE5 SDI

In this section:

- [Supported Cards](#)
  - [X.mio5 X2](#)
    - [Key Features](#)
    - [Connector Mapping](#)
  - [X.mio5/8](#)
    - [Key Features](#)
    - [Connector Mapping](#)
  - [DSX LE5/8 Low Profile](#)
    - [Key Features](#)
    - [Connector Mapping](#)
  - [DSX LE5/4 Low Profile](#)
    - [Key Features](#)
    - [Connector Mapping](#)
- [Changing Connector Mapping](#)
- [Multi-link Channels](#)
  - [Dual Link - Fill + Key](#)
  - [Quad Link UHD](#)

Matrox X.mio5 and DSX LE5 are two closely related series of PCI Express video boards with configurable SDI connectors. All connectors support HD and 3G SDI signals, and some support 12G as well. The main difference between the two series is that X.mio5 cards have an onboard video mixer to perform DVE effects, which DSX LE5 cards lack. The cards use either 8 or 16 PCI Express Gen 3 lanes.

Compared to their predecessors X.mio3 and DSX LE4, the series 5 cards lack several features:

- Watchdog functionality is not supported.
- SD formats are not supported.
- AES/EBU audio is not supported.

 **Important:** Due to the increased bandwidth, it is important to use high quality cables and as few connection points as possible for 12G signals. It is not recommended to use converter cables from Mini-BNC to standard BNC.

### Supported Cards

Viz Engine only supports a few cards from this series: X.mio5 X2, X.mio5/8, and DSX LE5/4 LP.

X.mio5 X2

The Matrox X.mio5 X2 is the strongest card of the series with 12 SDI connectors, one Genlock and a powerful onboard compositor.

This card requires Viz Engine 4.4 or newer.



Key Features

- Up to four 12G inputs (texture) and four 12G outputs with four 3G reconfigurable I/O.
- 12 completely reconfigurable 3G I/O connectors.
- Up to three DVE inputs in UHD.

Connector Mapping

The pin files needed to change the configuration of SDI connectors are located in the sub folder *Xmio5* (see Section Changing Connector Mapping below). The table below shows all possible combinations. Connectors capable of **12G** signals are marked with bold text, while connectors limited to 3G are in italic.



X.mio5 X2	Group 1				Group 2								
	0 in 12 out	1 in 11 out	2 in 10 out	3 in 9 out	4 in 8 out	5 in 7 out	6 in 6 out	7 in 5 out	8 in 4 out	9 in 3 out	10 in 2 out	11 in 1 out	12 in 0 out
12	<b>Out L</b>	<b>Out L</b>	<b>Out L</b>	<b>Out L</b>	<b>Out L</b>	<b>Out L</b>	<b>Out L</b>	<b>Out L</b>	<b>Out L</b>	<b>Out L</b>	<b>Out L</b>	<b>Out L</b>	<i>In L</i>
11	<b>Out K</b>	<b>Out K</b>	<b>Out K</b>	<b>Out K</b>	<b>Out K</b>	<b>Out K</b>	<b>Out K</b>	<b>Out K</b>	<b>Out K</b>	<b>Out K</b>	<b>Out K</b>	<i>In K</i>	<i>In K</i>



10	Out J	Out J	Out J	Out J	Out J	Out J	Out J	Out J	Out J	Out J	In J	In J	In J
9	Out I	Out I	Out I	Out I	Out I	Out I	Out I	Out I	Out I	In I	In I	In I	In I
8	Out H	Out H	Out H	Out H	Out H	Out H	Out H	Out H	In H	In H	In H	In H	In H
7	Out G	Out G	Out G	Out G	Out G	Out G	Out G	In G	In G	In G	In G	In G	In G
6	Out F	Out F	Out F	Out F	Out F	Out F	In F	In F	In F	In F	In F	In F	In F
5	Out E	Out E	Out E	Out E	Out E	In E	In E	In E	In E	In E	In E	In E	In E
4	Out D	Out D	Out D	Out D	In D	In D	In D	In D	In D	In D	In D	In D	In D
3	Out C	Out C	Out C	In C	In C	In C	In C	In C	In C	In C	In C	In C	In C
2	Out B	Out B	In B	In B	In B	In B	In B	In B	In B	In B	In B	In B	In B
1	Out A	In A	In A	In A	In A	In A	In A	In A	In A	In A	In A	In A	In A

X.mio5/8

The Matrox X.mio/8 has eight SDI connectors, one Genlock and an onboard compositor.

This card requires Viz Engine 5.0 or newer.

Key Features

- Up to four 12G inputs (texture) and four 12G outputs.
- Eight completely reconfigurable 3G I/O connectors.
- Up to two DVE inputs in UHD.



Connector Mapping

The pin files needed to change the configuration of SDI connectors are located in the sub folder *Xmio5lt* (see Section Changing Connector Mapping below). The table below shows all possible combinations. Connectors capable of **12G** signals are marked with bold text, while connectors limited to 3G are in italic.



X.mio5/8	Group 1								
Connector	0 In 8 Out	1 In 7 Out	2 In 6 Out	3 In 5 Out	4 In 4 Out	5 In 3 Out	6 In 2 Out	7 In 1 Out	8 In 0 Out
8	Out L	Out L	Out L	Out L	Out L	Out L	Out L	Out L	<i>In L</i>
7	Out K	Out K	Out K	Out K	Out K	Out K	Out K	<i>In K</i>	<i>In K</i>
6	Out J	Out J	Out J	Out J	Out J	Out J	<i>In J</i>	<i>In J</i>	<i>In J</i>
5	Out I	Out I	Out I	Out I	Out I	<i>In I</i>	<i>In I</i>	<i>In I</i>	<i>In I</i>

4	<i>Out D</i>	<i>Out D</i>	<i>Out D</i>	<i>Out D</i>	In D	In D	In D	In D	In D
3	<i>Out C</i>	<i>Out C</i>	<i>Out C</i>	In C	In C	In C	In C	In C	In C
2	<i>Out B</i>	<i>Out B</i>	In B	In B	In B	In B	In B	In B	In B
1	<i>Out A</i>	In A	In A	In A	In A	In A	In A	In A	In A

**DSX LE5/8 Low Profile**

The Matrox DSX LE5 LP/8 is a low profile card with eight I/O SDI connectors (four 12G and four 3G connectors) and one Genlock connector.

This card requires Viz Engine version 5.3.1 or later.



**Key Features**

- Eight freely configurable mixed 12G/3G SDI connectors.
- Low profile card.

**Connector Mapping**

The pin files needed to change the configuration of SDI connectors are located in the sub folder *Dsxle5lp* (see Section Changing Connector Mapping below). The table below shows all possible combinations. All connectors capable of handling **12G** signals are marked with bold text, while connectors limited to 3G are in italic.

**Important:** If used for a fill/key signal the used connectors are paired based on their possible bandwidth. If only one connector of the pair is available fill/key I/O is not possible.

DSX LE5/8 LP	Group 1			Group 2			Group 3		
	0 In 8 Out	1 In 7 Out	2 In 6 Out	3 In 5 Out	4 In 4 Out	5 In 3 Out	6 In 2 Out	7 In 1 Out	8 In 0 Out
8	<b>Out H</b>	<b>Out H</b>	<b>Out H</b>	<b>Out H</b>	<b>Out H</b>	<b>Out H</b>	<b>Out H</b>	<b>Out H</b>	<b>In H</b>
7	<i>Out G</i>	<i>Out G</i>	<i>Out G</i>	<i>Out G</i>	<i>Out G</i>	<i>Out G</i>	<i>In G</i>	<i>In G</i>	<i>In G</i>
6	<b>Out F</b>	<b>Out F</b>	<b>Out F</b>	<b>Out F</b>	<b>Out F</b>	<b>Out F</b>	<b>Out F</b>	<b>In F</b>	<b>In F</b>
5	<i>Out E</i>	<i>Out E</i>	<i>Out E</i>	<i>Out E</i>	<i>Out E</i>	<i>In E</i>	<i>In E</i>	<i>In E</i>	<i>In E</i>
4	<b>Out D</b>	<b>Out D</b>	<b>In D</b>	<b>In D</b>	<b>In D</b>	<b>In D</b>	<b>In D</b>	<b>In D</b>	<b>In D</b>

3	Out C	Out C	Out C	Out C	In C	In C	In C	In C	In C
2	Out B	In B	In B	In B	In B	In B	In B	In B	In B
1	Out A	Out A	Out A	In A	In A	In A	In A	In A	In A

### DSX LE5/4 Low Profile

The Matrox DSX LE5 LP/4 is a low profile card with four I/O SDI connectors and one Genlock.

This card requires Viz Engine version 5.0.0 or later.

#### Key Features

- Four freely configurable 12G SDI connectors.
- Low profile card.

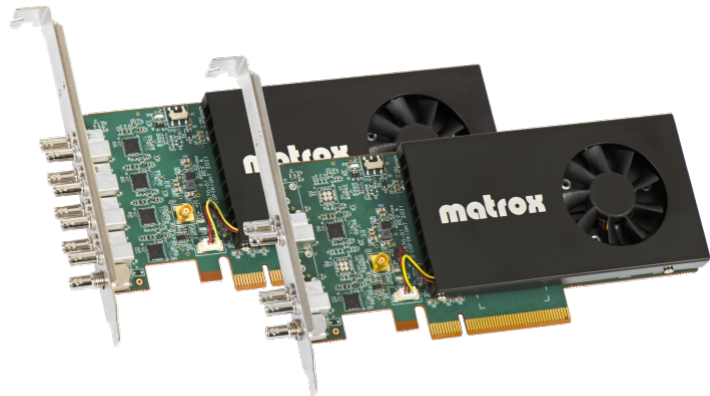

#### Connector Mapping

The pin files needed to change the configuration of SDI connectors are located in the sub folder *Dsxle5lp* (see Section Changing Connector Mapping below). The table below shows all possible combinations. All connectors are capable of handling **12G** signals and are marked with bold text.

DSX LE5/4 LP	Group 1				
	0 In 4 Out	1 In 3 Out	2 In 2 Out	3 In 1 Out	4 In 0 Out
4	Out F	Out F	Out F	Out F	In F
3	Out E	Out E	Out E	In E	In E
2	Out B	Out B	In B	In B	In B
1	Out A	In A	In A	In A	In A

### Changing Connector Mapping

The I/O configuration can be changed by using a read-only configuration file located in the folder ***Xmio5Le5ConnectorMapping***, where the Matrox drivers are installed (normally under *C:\Program Files\Matrox DSX-TopologyUtils\drivers*).

1. Make sure that neither Viz Engine nor any other processes are using the card.
2. From the drivers folder that contains *mvConnectorConfig.exe*, open the command prompt (administrator privileges are requested).

3. Call `mvConnectorConfig.exe load -f="C:\path\to\file.pin" -sn=Axxxxxx` . Replace `Axxxxxx` with the serial number of the card you want to configure.

Pin files for different card models are located in different sub folders of `Xmio5Le5ConnectorMapping` . The name of each file indicates the number of inputs and outputs. Provide the full path, within quotation marks, to the desired file. Using relative paths does not work and can flash the card to an invalid status. If this happens, flash the card again with the absolute path.

**Example:** To configure an X.mio5 X2 with serial number A123456 to use the first **four** connectors as inputs and the other **eight** as outputs, use the command: `mvConnectorConfig.exe Load -f="C:\Program Files\Matrox DSX-TopologyUtils\drivers\Xmio5Le5ConnectorMapping\Xmio5\xmio5_x2_04i08o.pin" -sn=A123456`

**Information:** On some cards, the connector mappings are split into different groups, as marked in the respective tables. When changing between configurations inside the same configuration group, the command should take one to two seconds to process the new configuration and a restart of the computer is not needed. When the change of configuration involves going from one configuration family to the other, this will take some time, since a firmware upgrade takes place (empirically five to ten minutes) and it requires a system restart (command line waits for user input on whether the restart should happen now or not).

## Multi-link Channels

Input or output channels of Viz Engine require multiple SDI connectors if they include a key signal, use 3G quad link, or both.

### Dual Link - Fill + Key

For channels that use a single fill connector (including 12G UHD), the easy rule to determine the associated key connector is "Fill A Key B", "Fill C Key D", and so on. This applies to both input and output channels. The main connector of a channel is always the fill connector. A channel that is mapped to connector B, D, and so on, can not have a key signal.

### Quad Link UHD

Viz Engine only allows quad 3G configurations on connectors A, E and I (both for inputs and outputs). If one of those connectors is used as the base connector of a quad link channel, the next three connectors are automatically assigned to that channel and no longer available. For example, if connector A is chosen, it is the first one in the set and B, C and D are automatically used. Same for E (F, G, H) and I (J, K, L). As an exception to this, DSX LE5/4 LP only has connectors A, B, E, and F. Only connector A is available as the base connector of a quad-link channel and the remaining connectors are used in order.

Each quad-link connector can be configured to use either square division or 2SI. Please see Matrox Configuration for further details.

It is possible to combine quad link with a key signal. In that case, there are only two possible connector mappings on X.mio5 X2, assuming that the connectors are available: If fill uses [A,B,C,D] then key automatically uses [E,F,G,H].

If fill uses [E,F,G,H], then key automatically picks [I,J,K,L]. On X.mio5/8, there is only one option: Fill uses [A,B,C,D] and key uses [I,J,K,L].

## Matrox Driver Installation

The first time a machine is started with a Matrox board or dongle installed, the operating system prompts the user to install the necessary Matrox drivers. Before installing a new driver, or upgrading the existing drivers, any currently installed drivers must be removed, see [To Remove the Matrox Driver](#) below.

**✘ Important:** Windows 10 systems with Secure Boot enabled require that you install a special driver. These drivers are labeled with an `_EV` in the filename, for example `DSX-TopologyUtils_EV.exe`.

Please pay attention to the following considerations:

- A new driver should not be installed before the new hardware is installed.
- The use of a different driver version than that which was shipped with the video board is not recommended.
- In most cases, using a driver version that is not recommended causes the system to be unresponsive.
- Use the supplied driver installer application and do not rely on drivers automatically installed by the operating system.
- Please refer to the Drivers and Configuration History section for information on which driver version is recommended for the Matrox video card and Viz Engine version in use. As there are many driver versions available, it is important to compare the versions reported by the Matrox X.info utility to check that the driver and firmware versions match. A warning is displayed if the versions do not match.

This section contains information on the following topics:

- [To Install the Matrox Driver](#)
- [To Remove the Matrox Driver](#)
- [To Upgrade the Matrox Driver](#)
- [To Check the Installation](#)
- [To Check the Installation with Windows Device Manager](#)

### To Install the Matrox Driver

1. Locate the latest Matrox driver (DSX-Topology Utils): <ftp://ftp.vizrt.com/products/Vizrt%20Drivers/Matrox/Xmio/<driver>/>.
2. Download and save the installation file to the local hard drive.
3. Open the downloaded `DSX-TopologyUtils.exe` file. This file automatically extracts the installation files and launches the installation wizard.
4. Select *Matrox DSX Topology* and follow the on screen instructions.

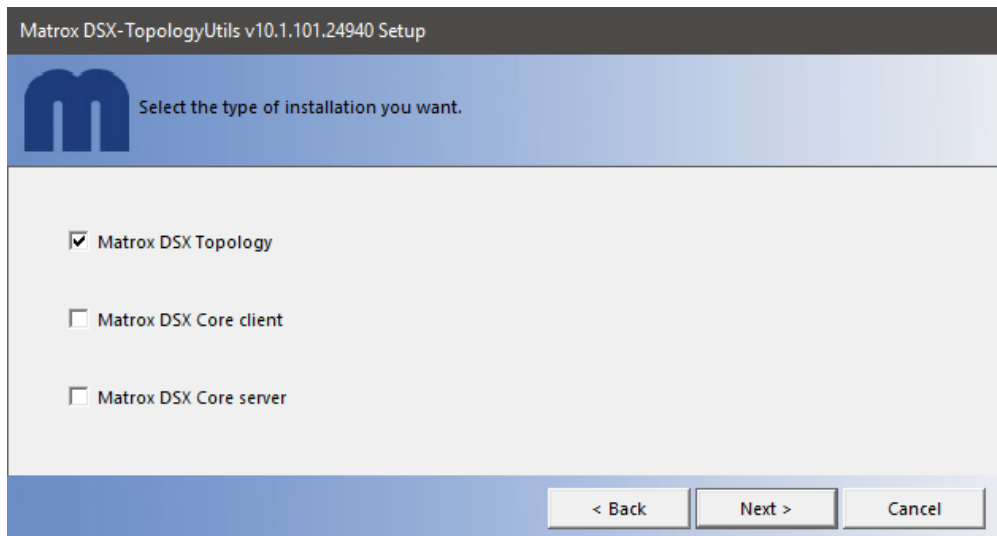

- In case the Windows Security window pops up, tick the **Always trust software from Matrox Electronic Systems** check-box. This allows for a faster installation procedure in any subsequent driver installations. If left un-checked, each required driver needs explicit permission to be installed.

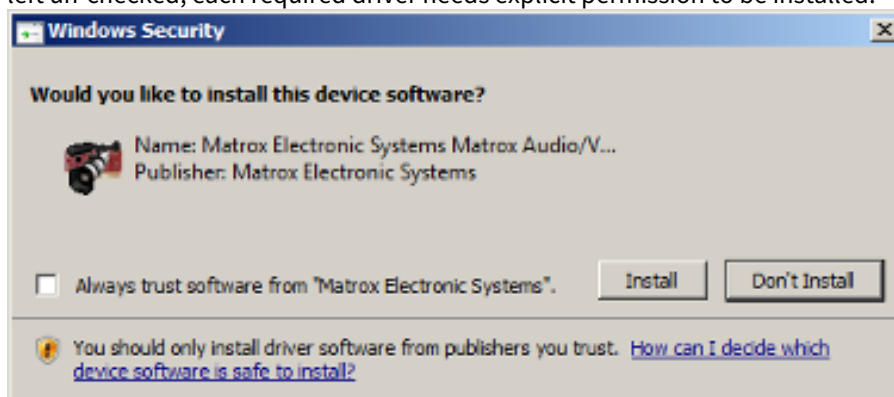

- Click **Install** to start the installation. The installation can take several minutes.
- After the driver has been installed, an icon (1) appears in the system tray.

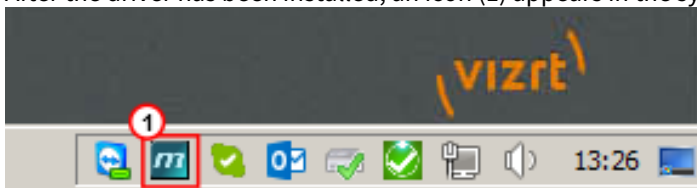

**Note:** The firmware upgrade now starts. This can take a few minutes to complete.

### To Remove the Matrox Driver

- Go to **Start > Control Panel > Programs and Features**.
- Locate the *Matrox DSX.utils <version>*.
- Click the **Uninstall** button, or right click the entry and select **Uninstall** from the context menu.
- Follow the on screen instructions.



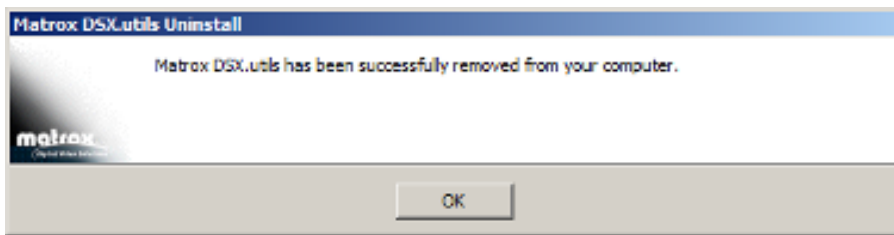

5. Reboot the system.

 **Tip:** In some cases, the Matrox driver removal process automatically reboots the system.

### To Upgrade the Matrox Driver

1. Remove the old *DSX.utils* (see To Remove the Matrox Driver).
2. Reboot system.
3. Install the new *DSX.utils* (see To Install the Matrox Driver).

### To Check the Installation

1. Click the Matrox system tray icon.
2. Select **Open X.info**.



3. In the Display Information About drop-down, select **System**.

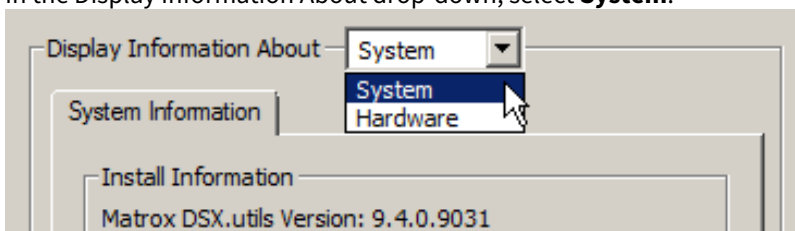

4. Check that the correct driver version was installed.

The screenshot shows a software configuration window with two main sections. The top section, titled "Install Information", displays the version "Matrox DSX.utils Version: 9.4.0.9031" and a text box for the "Matrox DSX.utils Path" containing the value "C:\Program Files\Matrox DSX.utils". The bottom section, titled "System Information Log", features a text box with the path "C:\Users\dco\AppData\Local\Temp\SystemLog.html", a "Browse..." button, a checked checkbox labeled "Open file after scan", and a "Create" button.

5. In the **Display Information About** drop-down, select **Hardware** and click on the installed card tab, for example **LE3/22C**.

**Note:** The information shown in the panel can look different depending on the installed Matrox card.

The screenshot displays the configuration interface for an LE3 /22C Card. It features two tabs: 'LE3 /22C Card' (selected) and 'Display Card'. The 'Hardware Information' section includes a 'Serial Number: A497596', 'Board ID: 0', 'Production Date: 2013-06-19', 'Installed Options: Compositor, Scaler', 'Firmware Revision: Primary Dev. 0.6.0, Secondary Dev. 0.17.3', 'EEPROM Revision: 5.0', 'Memory Size: 512 MB', 'PCI Bus Info: PCI Express X8', and 'Hardware Model: DSXLE3/550'. An 'Upgrade Model' button is located in the top right of this section. The 'Temperature (°C)' section shows three temperature gauges: 'Backplane' (Current: 48.0, Max: 65.0), '1st FPGA' (Current: 71.2, Max: 85.0), and '2nd FPGA' (Current: 54.6, Max: 85.0). Each gauge has a green bar indicating the current temperature level.

6. Check the these details:
  - a. Under Hardware Information, check the Installed Options for Compositor, to confirm that the board is taking advantage of the on-board compositor. Some boards do not have an on-board compositor. The Matrox X.mio2 Plus does have an on-board compositor, even though this is not listed.
  - b. See PCI Bus Info and check that the board was put into a PCIe slot operating at the right frequency.
  - c. See Hardware Model, for example, X.mio2 Plus 8500, to check for Mixed Mode Video Support.

To Check the Installation with Windows Device Manager

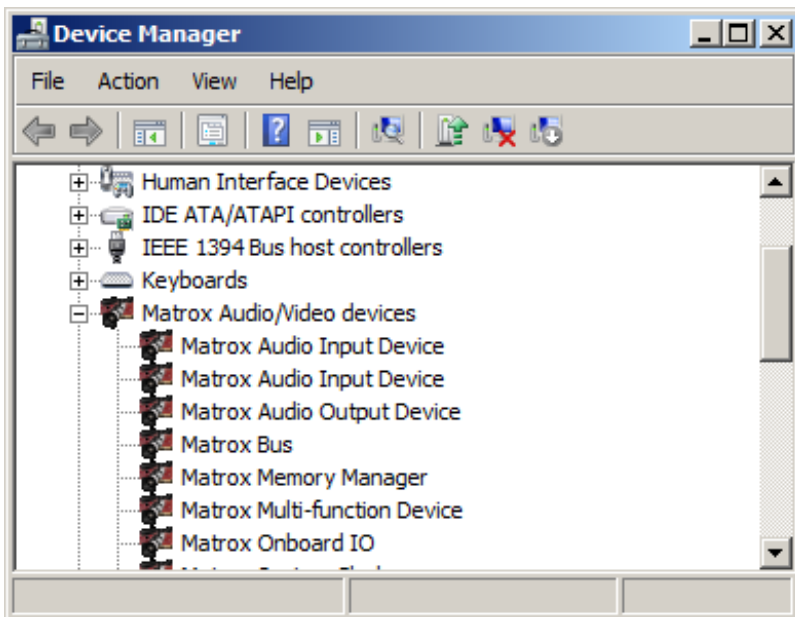

1. Start the **Device Manager**, by either:
  - a. Click **Start**, then **Run**, and type `devmgmt.msc`, or
  - b. Right-click **My Computer**, select **Manage** and then **Device Manager**, or
  - c. Right-click **My Computer**, select **Properties** and click the **Hardware** tab, then click **Device Manager**, or
  - d. Run the command star `devmgmt.msc` from the **Command Prompt**
2. Expand the **Matrox Audio/Video devices** node to see the devices that are installed.

## Troubleshooting Matrox Video Hardware

It might be necessary to reset the Matrox board. This needs to be done for example when Viz Engine reports:

- "0xefac9019: Generic driver error: The requested operation was unsuccessful" at startup.
- "0xeddd8008: Topology driver error: Watchdog specified already in use by another application." at startup.
- "VideoClipInOut::SequenceVideoOut SequenceVideoOut no output node." during operation.

For this a reset mechanism has been implemented for the Viz Engine. To activate this mechanism, do this procedure:

1. Stop all Viz Engines (in dual channel setups both Viz Engines must be stopped).
2. Open the Viz Configuration file.
3. Set `Matrox0.ResetTopology = 1`.
4. Start up the respective Viz Engines.

**Note:** The `Matrox0.ResetTopology` setting is automatically set back to `0` after the reset has been performed.

The reset feature also clears the on-board memory of the Matrox board. This operation removes all Matrox topologies from the on-board memory. After the reset, everything is restored automatically according to the configuration settings. This also applies to both Viz Engines in a Dual Channel setup.

## Disable Warmboot

Matrox boards do not support Warmboot or Fastboot options. Please make sure the registry entries for `HiberbootEnabled: Computer\HKEY_LOCAL_MACHINE\SYSTEM\CurrentControlSet\Control\Session Manager\Power` and `HibernateEnabled: Computer\HKEY_LOCAL_MACHINE\SYSTEM\CurrentControlSet\Control\Power` are both set to be deactivated.

## Replacing a Video Board

This procedure describes how to safely replace a video board on a system with an existing video board, or a system that previously has had a video board installed.

1. Remove the video board drivers.
2. Shut down the machine.
3. If present, remove the currently installed video board.
4. Install the replacement video board.
5. Install the video board drivers.



**IMPORTANT!** When changing a Matrox video board the *Matrox.Devices* setting, set in the Viz Config file's `SECTION MATROX_CONFIG`, is not updated. The Matrox support is not correct and the new board does not work. In this case, the setting must be removed and Viz Engine restarted such that Viz Engine can insert the new serial number.

### 6.4.3 BlueFish444

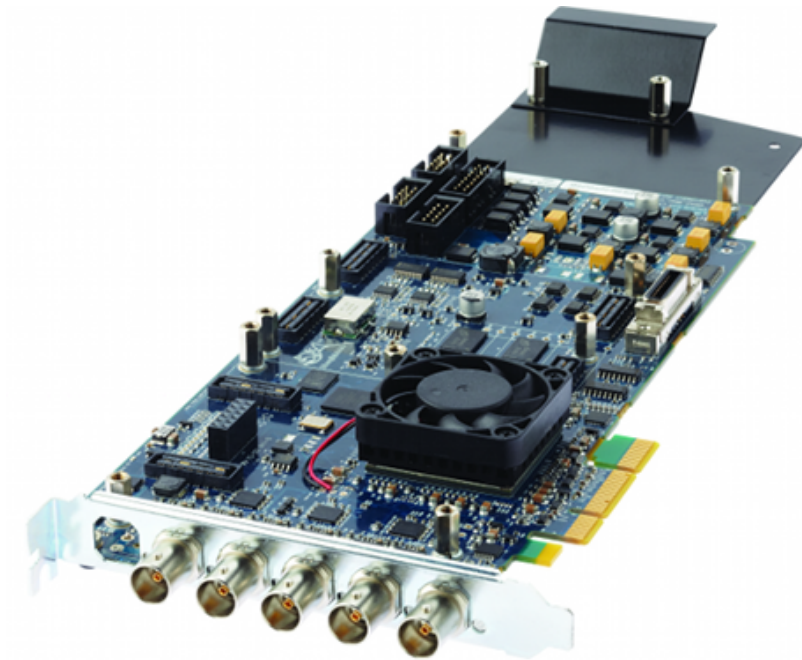

Viz Engine supports the following BlueFish444 video boards:

- Epoch | 4K Supernova
- Epoch | 4K Supernova S+
- Epoch | Neutron (introduced in Viz version 3.7.0)
- Kronos | K8 (introduced in Viz version 5.0.0)

Some of the main supported features are:

- Embedded audio input and output.

**Note:** All 16 channels are used; however, there are currently no configuration options available for these channels (for example, routing of channels, enable/disable channels etc.).

- ANC data (both HANC and VANC), such as VITC and RP188 time codes, is supported. Data from the input is laid over the output. Ingestion of time codes from time code reader boards is supported as well.
- Two video inputs and outputs and one Genlock.
- Automatic bypass (aka [Special Configuration Options for Bluefish444](#)) of video if the Viz Engine crashes.
- Constant delay of four frames from input to output.

**Note:** Other BlueFish444 and Digital Voodoo boards are no longer supported.

## Configuration History for BlueFish444

Use the driver version available on the [Vizrt FTP server](#) to make sure of correct functionality and ringbuffer support.

The following driver and firmware versions are supported:

Viz Release	Driver Version	Supernova Firmware	Neutron Firmware	Kronos K8 Firmware
5.3	<a href="#">6.5.1.22</a>	2i2o 162		
5.0, 5.1, 5.2	6.5.1.22	2i2o 162	1i2o 35	4i4o 1.4 build 41
4.0, 4.1, 4.2, 4.3, 4.4	5.11.0.45	2i2o 145	1i2o 027	N/A
3.9.0 - 3.14.x	5.11.0.45	2i2o 145	1i2o 027	N/A
3.8.1 - 3.8.2	5.11.0.39	2i2o 134	1i2o 025	N/A
3.8.0	5.11.0.25	2i2o 127	1i1o 067	N/A
3.7.1	5.11.0.14	2i2o 108	1i1o 054	N/A
3.7.0	5.11.0.7	2i2o 096 Rev. 2	1i1o 016 Rev. 2	N/A
3.6.4	5.11.0.3	2i2o 096	N/A	N/A
3.6.3	5.10.2.18	2i2o 094	N/A	N/A
3.6.1 - 3.6.2	5.10.2.4	2i2o 053	N/A	N/A
3.5.1 - 3.5.4	5.10.1.11	2i2o 031	N/A	N/A
3.5.0	5.9.0.78	442	N/A	N/A



## Epoch Neutron



The Epoch | Neutron is a full-length PCIe card with three bi-directional multi-format I/O BNC connectors that support dual link configurations. For use with Viz Engine, the card needs to be configured with one input and one output. Of the three BNC connectors, the first two do SD, HD1.5G, 3G, ASI, AES and LTC as either input or output. The third is used for Genlock.

✔ **Tip:** The Epoch | Neutron is capable of downstream keying. To achieve this, add a Media Asset as DVE when creating a scene in Viz Artist.

## Epoch | Neutron Connectors

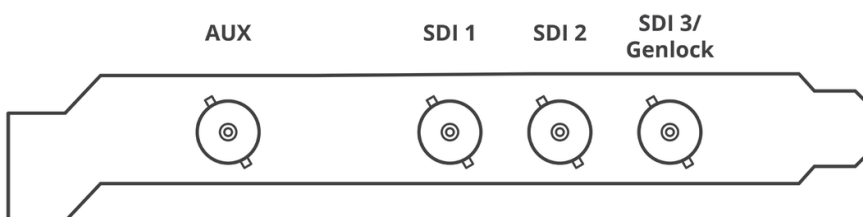

On the Epoch | Neutron, the default connector configuration for the four connectors are:

- AUX connector (Not Used)
- (empty space)
- Output one (fill)
- Input one
- Reference IN

If the `dual_link_output` flag is set to `1` in the Viz configuration file, the key output is enabled on the bottom BNC connector. The Genlock signal gets moved to the AUX connector at the top.

- Reference In
- (empty space)
- Output one (fill)
- Input one
- Output two (key)

Please refer to the [Special Configuration Options](#) section for more information.

**See Also**

- [Configuration History for BlueFish444](#)
- [Special Configuration Options](#)
- [Video Board](#)
- [Media Assets as DVE in the Viz Artist Guide](#)

## Epoch Supernova

The BlueFish444 Epoch | 4K Supernova, Epoch | 4K Supernova S+ and Epoch | Supernova CG boards are intended for character generators such as Viz Trio, but can also be used as an alternative where only two inputs and outputs are required.

**Note:** When the 0in4out firmware is used on the Epoch Supernova cards, two instances of Viz Engine can run simultaneously (Dual Channel setup). The assignment of fill/key connectors is automatic and cannot be changed in this case.

This section contains information on the following:

- [Epoch | 4K Supernova](#)
  - [Epoch | 4K Supernova Connectors](#)
- [Epoch | 4K Supernova S+](#)
  - [Epoch | 4K Supernova S+ Connectors](#)
- [Epoch | Supernova CG](#)
  - [Epoch | Supernova CG Connectors](#)

## Epoch | 4K Supernova

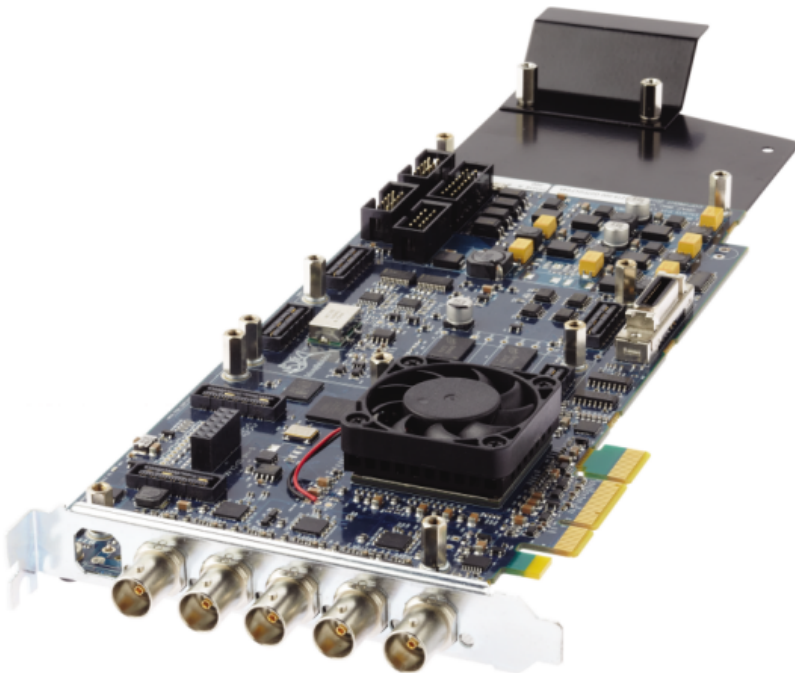

The Epoch | Supernova is a full-length PCIe card with five bi-directional multi-format I/O BNC connectors that support a number of configurations with up to two dual link channels or four single link channels. For use with Viz Engine, the card needs to be configured with two inputs and two outputs.

### Epoch | 4K Supernova Connectors

With five BNC connectors, each of the first four do SD, HD, 3G, ASI, AES and LTC as either input or output. The fifth is the designated GenLock or SD, HD, 3G, ASI or AES (no LTC).

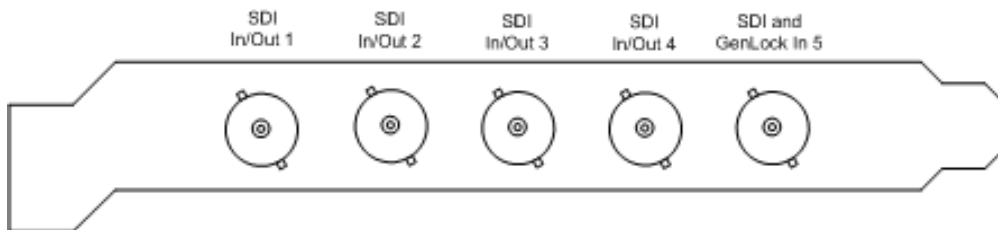

On the Epoch | 4K Supernova, the default connector configuration for the five connectors are:

- Output one
- Input one
- Output two
- Input two
- Reference In (Genlock)

If the `dual_link_input` flag is set to `1` in the Viz Configuration file, the two inputs are treated as one channel with fill on the first and key on the second. Please refer to the [Special Configuration Options for Bluefish444](#) section for more information.

### Epoch | 4K Supernova S+

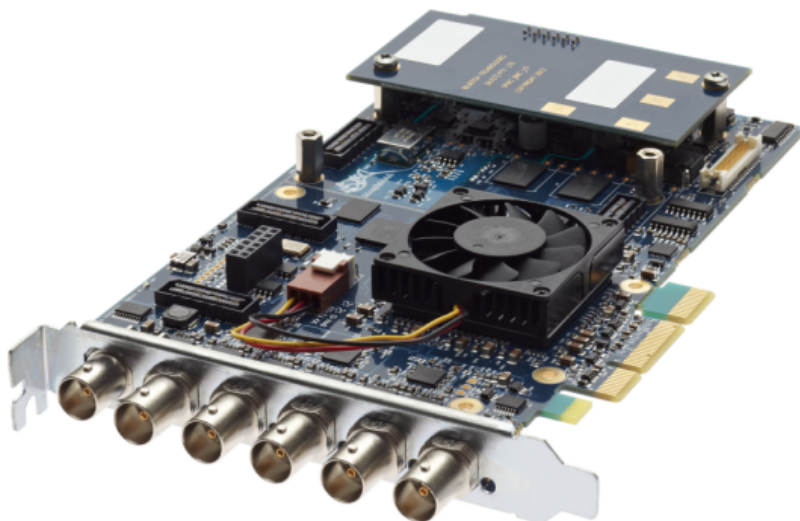

The Epoch | Supernova S+ is a 2/3-length PCIe card with bi-directional multi-format I/O BNC connectors that support a number of configurations, up to two dual link channels or four single link channels. For use with Viz Engine, the card needs to be configured with two inputs and two outputs. With six BNC connectors, each of the first four do SD, HD, 3G, ASI, AES and LTC as either input or output. The fifth is the designated GenLock or SD, HD, 3G, ASI or AES (no LTC).

### Epoch | 4K Supernova S+ Connectors

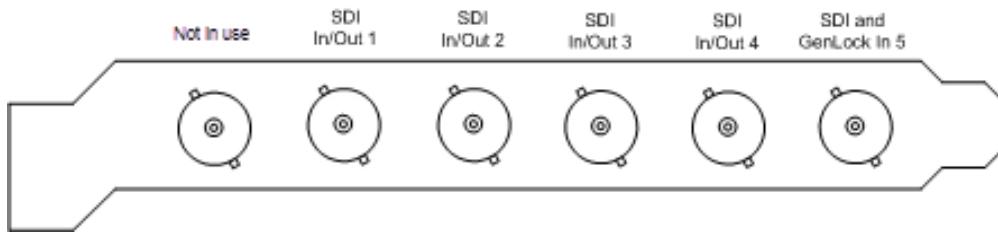

On the Epoch | 4K Supernova S+, the default connector configuration for the six connectors are:

- *Not in use*
- Output one
- Input one
- Output two
- Input two
- Reference In (Genlock)

**⚠ Note:** Viz Engine does not utilize the top BNC connector on the Epoch | 4K Supernova S+ video card, recognized as not being flush with the other five.

If the `dual_link_input` flag is set to `1` in the Viz Configuration file, the two inputs are treated as one channel with fill on the first and key on the second. Please refer to the [Special Configuration Options for Bluefish444](#) section for more information.

### Epoch | Supernova CG

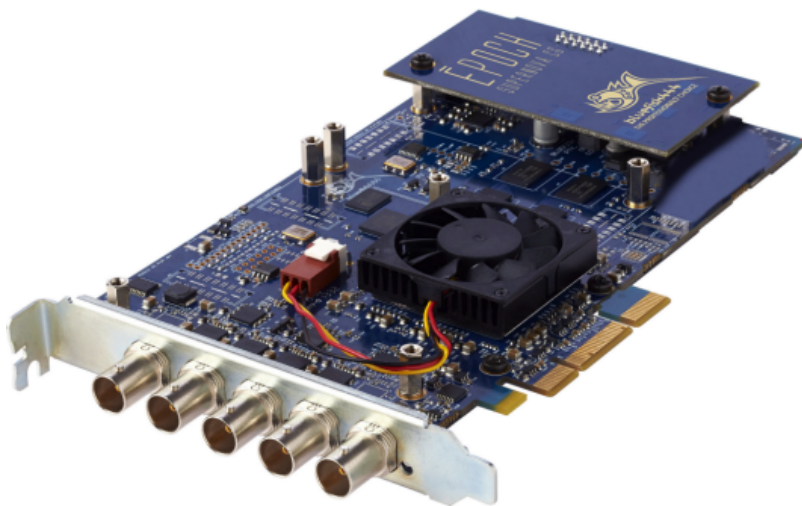

The Epoch | Supernova CG is a 2/3-length PCIe card with bi-directional multi-format I/O BNC connectors that support a number of configurations, up to two dual link channels or four single link channels. For use with Viz Engine, the card needs to be configured with two inputs and two outputs. With five BNC connectors, each of the first four do SD, HD, 1.5G, ASI, AES and LTC as either input or output. The fifth is the designated GenLock or SD, HD, 1.5G, ASI or AES (no LTC).

## Epoch | Supernova CG Connectors

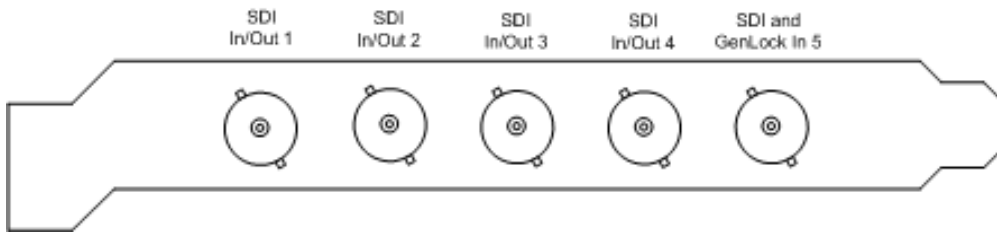

On the Epoch | Supernova CG, the default connector configuration for the five connectors are:

- Output one
- Input one
- Output two
- Input two
- Reference In (Genlock)

If the `dual_link_input` flag is set to `1` in the Viz Configuration file, the two inputs are treated as one channel with fill on the first and key on the second. Please refer to the [Special Configuration Options for Bluefish444](#) section for more information.

**See Also**

- [Configuration History for BlueFish444](#)
- [Special Configuration Options for Bluefish444](#)
- [Video Board](#)

### Kronos



The Kronos K8 is a full-length PCIe card with ten HDBNC connectors. Eight of those are used for SDI IO, the other two are reference connectors. For use with Viz Engine, the card needs to be configured with four inputs and four outputs. The connectors support SD, HD 1.5G, 3G, ASI, AES and LTC as either input or output. In addition the card has a reference input and a reference output connector.

### Kronos K8 Connectors

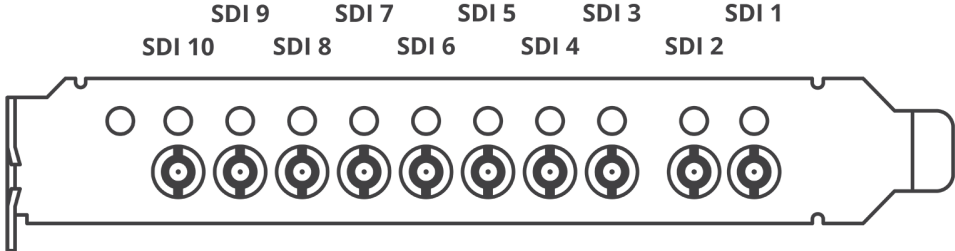

SDI Connector	Function
1	Reference In
2	Reference Out
3	Output Fill
4	Input 1
5	Output Key

SDI Connector	Function
6	Input 2
7	-
8	Input 3
9	-
10	Input 4



## Special Configuration Options for Bluefish444

This section describes the procedures to configure the following options when running a Bluefish444 setup:

- [To Enable Dual Link Input for Epoch | 4K Supernova and Epoch | 4K Supernova S+ Boards](#)
- [To Enable Dual Link Output for Epoch | Neutron](#)
- [To Enable Automatic Bypass for BlueFish444 Epoch Boards](#)

### To Enable Dual Link Input for Epoch | 4K Supernova and Epoch | 4K Supernova S+ Boards

1. Stop Viz Engine.
2. Open the **Viz Configuration file** (for example: *VIZENGINE-0.cfg*).

**Note:** The default location for this file is `%ProgramData%\Vizrt\VizEngine`.

3. Locate `SECTION VIDEO`.
4. Enable the **Dual Link Input** setting by changing the default value `0` to `1`: `dual_link_input = 1`.
5. Save the file.
6. Start Viz Engine.

### To Enable Dual Link Output for Epoch | Neutron

1. Stop Viz Engine.
2. Open the **Viz Configuration file** (for example: *VIZENGINE-0.cfg*).

**Note:** The default location for this file is `%ProgramData%\Vizrt\VizEngine`.

3. Locate `SECTION VIDEO`.
4. Enable the **Dual Link Output** setting by changing the default value `0` to `1`: `dual_link_output = 1`.
5. **Save** the file.
6. Start Viz Engine.

### To Enable Automatic Bypass for BlueFish444 Epoch Boards

Viz Engine supports automatic mechanical bypass (copper-to-copper) of video for BlueFish444 Epoch boards. To use this feature enable the feature.

1. Stop Viz Engine.
2. Open the **Viz Configuration file**
3. Locate `SECTION VIDEO`.
4. Enable the Watchdog setting by changing the default value `0` to `1`: `video_use_watchdog = 1`.
5. **Save** the file.
6. Start Viz Engine.

#### See Also

- [Configuration History for BlueFish444](#)
- [Video Board](#)

## 6.4.4 Aja Hardware

Viz Engine with AJA Hardware supports up to two 3G-SDI inputs and fill/key output.

This section contains information on the following topics:

- [Overview and Connectors](#)
- [Configuration](#)
- [Audio Configuration](#)
- [Video Configuration](#)
- [Configuration Utilities](#)
- [Firmware Upgrade](#)

### Overview and Connectors

AJA boards support current SD and HD SDI workflows with frame rates up to 50p/59.94p. Audio is supported as embedded signal in the SDI stream.

### Configuration

 **IMPORTANT!** For 1080p, only 3G Level A is supported.

### Audio Configuration

Embedded audio is supported, always with 16 channels in and out. However, mixer settings are active, and respected. Example: if the user requests only two-channel output, the remaining 14 channels are silent.

### Video Configuration

The default configuration is:

Live Input 1	SDI 1
Live Input 2	SDI 2
Fill Output	SDI 3
Key Output	SDI 4
Genlock	[REF IN]

If Live Input 2 is inactive in the configuration, SDI 2 is enabled for preview output.

 **Info:** For 1080p, only one input is supported.

## Configuration Utilities

Vizrt includes two configuration utilities from AJA:

- **cables.exe:** This utility shows the current topology running: Inputs, outputs, color space conversion, fill and key paths. Firmware and driver version information are also accessible. Screen-shots of *cables.exe* use showing two typical topologies (two video inputs and one video and one preview) are shown below:

**Example:** Topology using two video inputs:

The screenshot displays the AJA OEH 2K Router configuration utility interface. The main window shows a complex signal flow diagram with various components like Frame Store, CSC, LUT, and DL blocks. Below the diagram is a 'Reference' table with the following data:

Reference	
<input type="radio"/> SDI 1(In):	720p 50
<input type="radio"/> SDI 2(In):	720p 50
<input type="radio"/> SDI 3(Out):	N/A
<input type="radio"/> SDI 4(Out):	N/A
<input checked="" type="radio"/> Ref In:	720p 50
<input type="radio"/> Free Run:	720p 50
<input type="radio"/> HDMI In:	No Video
<input type="radio"/> Analog In:	N/A

**Example:** One video input, one preview:

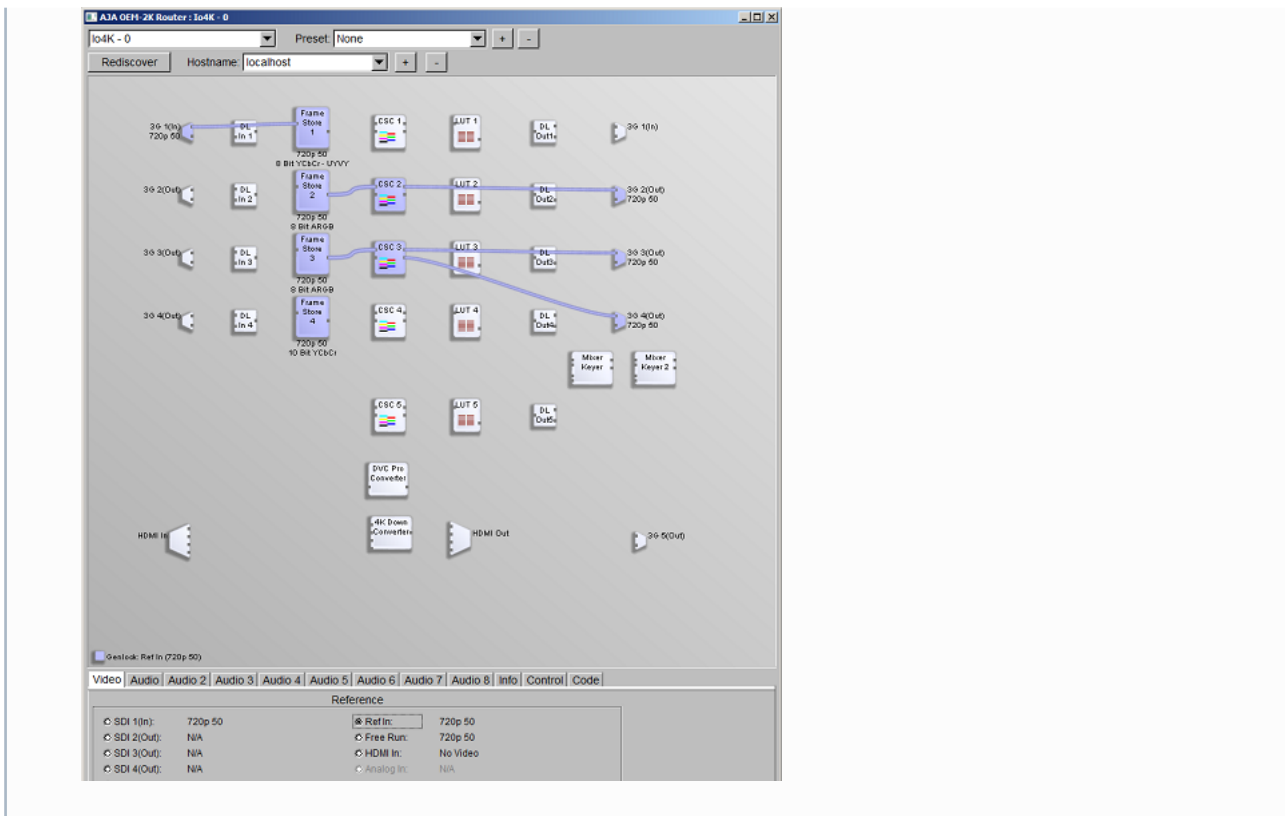

- **watcher.exe:** This utility shows register settings. You may also write out a status log file. The auto-circulate engine is also observable. This utility is mostly of value for support specialists.

## Firmware Upgrade

Only do an upgrade of Io4K firmware if instructed to do so by Vizrt or AJA support. All files for firmware upgrade are provided in a separate directory, typically supplied as a zip-archive. To install the firmware:

1. Open a command window.
2. `cd` to the directory where the firmware upgrade files are located. Make sure no other programs are running that could interfere with the firmware upgrade.
3. Install the firmware, in this example named `IO_XT_4K_13.bit`, using the `ntv2firmwareinstaller` utility (for example, `ntv2firmwareinstaller -f IO_XT_4K_13.bit`).
4. The window then pauses for a few minutes. When the firmware upgrade is complete, the command line program asks for a return key press to exit. Please be patient, the firmware upgrade can take three to six minutes (or more, depending on hardware configuration).
5. Power-cycle the Io4K and reboot the computer to make sure the upgraded firmware configuration is active.

### See Also

- Manufacturer's documentation (external link at [www.aja.com](http://www.aja.com)): [AJA Io 4K](http://www.aja.com)

## AJA Io 4K Plus

### Overview and Connectors

The AJA Io 4K Plus is the next generation of this series. The only differences related to the implementation with Viz Engine and the hardware are the usage of Thunderbolt 3 as connection interface, and the fact that the Ref In/LTC In and LTC Out connectors changed places.

As with its predecessor, only the connectors SDI 1 - 4 and the Ref In connector are implemented for use in Viz Engine. For information on the connector mapping, please see AJA Hardware.



**i Information:** Newer devices might require an update of the firmware. [16.1.0.3](#) driver has been tested with 2021/06/23 firmware.

## AJA Kona 4

### Overview and Connectors



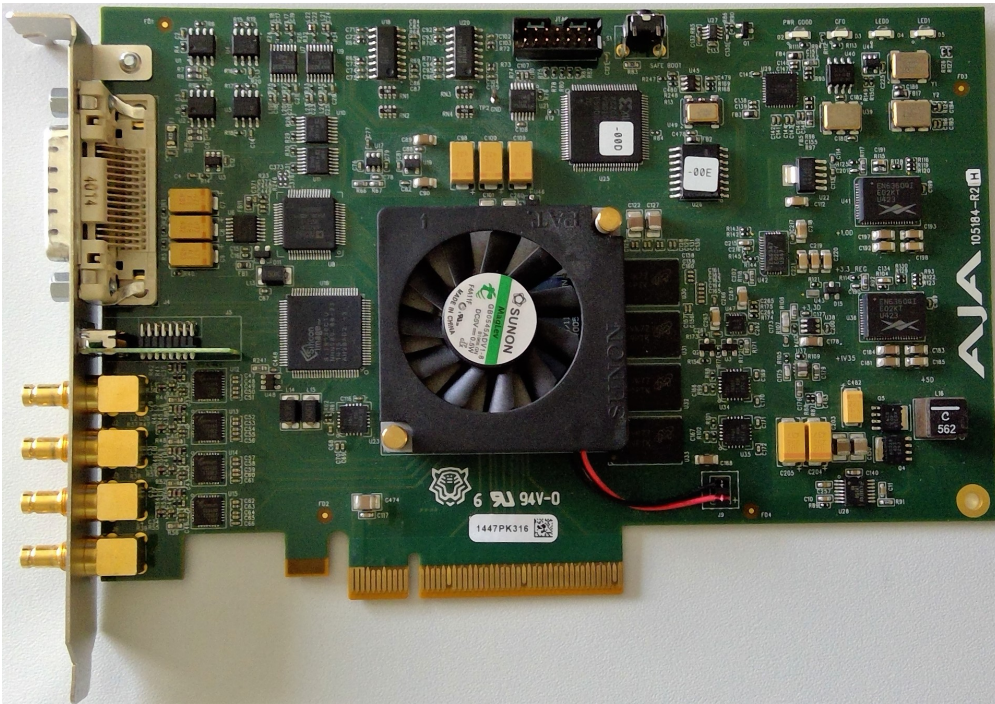

Only the connectors SDI 1 - 4 and the Ref In connector are implemented for use in Viz Engine. For information on the connector mapping please see [Aja Hardware](#).



## 7 Starting Viz Engine

To start and run Viz Engine, you need to connect to an available Graphic Hub. Viz Engine can also be started with various options included (see [Viz Command Line Options](#)). To start Viz Engine with an option or options, the command for that option must be added before Viz Engine start-up.

### 7.1 To Start Viz Engine

1. Start Viz Engine.
2. In the Graphic Hub login window, provide the required details:
  - a.  : Select a Host from the drop-down list. You can also type the host name, if the host does not appear in the list. This may happen if the server is on a different sub-net.
  - b.  : Select a Graphic Hub from the drop-down list.
  - c.  : Select a User from the drop-down list.
  - d.  : Type the correct password for the selected User.
  - e. **Log me in automatically:** If auto log in is available, click to enable automatic log on. This makes Viz Engine automatically connect and log on to a pre-defined Graphic Hub on start-up.
3. Click **Log in**.

### 7.2 To Add A Viz Engine Startup Option

1. Right click the Viz Engine icon and select **Properties**.
2. In the **Shortcut** pane, apply a command in the **Target** field (see [Viz Command Line Options](#)).

 **Example:** "%ProgramFiles%\vizrt\VizEngine\viz.exe" -n

3. Click **OK**.
4. Start Viz Engine.

#### 7.2.1 Viz Configuration

Viz Artist/Engine is mainly configured by the [Configuring Viz](#) application. All configuration settings are stored in the Viz Config file, found in the *<viz data folder>*. The Viz Config file uses the machine host name to uniquely identify which machine Viz Artist/Engine is installed on, as for example, *VizEninge-0.cfg*.

Any changes to the host name affect the Viz Artist/Engine. If a host name is changed, a new Viz Config file is created with a default setup. The old Viz Config file is not deleted, but left unused. If required, use the command `-g <configuration file>` (see [Viz Command Line Options](#)) to reassign the old Viz Config file.

 **IMPORTANT!** Viz Engine ignores text following a Hash tag. Do not use the Hash tag (#) in any folder, file or path name.

## 7.2.2 To Migrate a Previous Viz Configuration

Viz Engine automatically migrates existing Viz 3 configurations if:

- There is no valid Viz config file.
- A sentinel file can not be found in the Viz folder.

## 7.2.3 Deleting Shader Cache

Sometimes it is required to remove the shader cache and rebuild it from scratch if Viz Engine hangs during startup, the GPU driver has changed or the GPU itself has been replaced.

To do so, remove the content of the the following folders:

- `%userprofile%\AppData\Local\NVIDIA\GLCache`
- `%programdata%\vizrt\VizEngine\ShaderCache`

 **Note:** Depending on your CPU, compiling Shaders might require up to 15 minutes.



## 7.3 Viz Console

The Viz Console window is mainly used for debugging purposes, to display information about the running Engine or connected Graphic Hub, and for manually sending commands directly to the Engine. The Viz Console shows the commands that are used in communication between the Viz Engine Renderer and other components, such as Viz Artist, External Control Applications, plug-ins, and scripts.



For an overview of the available commands, open the console window and type `?` or `help`, then press enter.

This outputs a list of the available console commands. The complete documentation for the command interface is included with the Viz installation, and can be found under `<Viz Install Folder>\Documentation\CommandInterface`.

**✘ IMPORTANT!** The Viz Console is case sensitive.

### 7.3.1 Autocompletion Feature

Introduced in Viz Engine version 5, the console offers an autocompletion feature when sending commands directly to the console. To use this, hit the **TAB** key on any location.

#### Example

Type `send RENDERER` and hit the **CTRL+TAB** Key:

```
# send RENDERER*##1
##1
ANIMATION
BACK_LAYER
COMMANDS_XML
CONTENTS_VISIBLE
COORDINATE_SYSTEM
CSC
CURRENT_CAMERA
EYE_SEPARATION
FORMAT
FRONT_LAYER
GRID
HUD
KEY_INTERNAL
MAIN_LAYER
MIDDLE_LAYER
OBJECT_ID
OBJECT_TYPE
OVERWRITE_STEREO
PERFORMANCE
PICK_LAYER
PICK_QUAD
PICK_QUAD_DATA
POST
POST_MODE
SAA
SHORTCUTS
SHOW_SAFE_AREA
SHOW_TITLE_AREA
SIMULATE_INPUT
STEREO_PARAMETERS
TEXT_EDITOR
UPDATE
VGA_PREVIEW
VIEW
ZERO_PARALLAX_DIST
ANTIALIASE
CAPTURE_ENVIRONMENT_MAP
CLOSE
COMMAND_COMPLETE
COMMAND_EXIST
COMMAND_INFO
CREATE_FSWINDOW
DROP
DROPINZ
DROPZ
GET_OBJECT
GET_OBJECT_LOCATION_PATH
GET_WINDOW_INFO
INITIALIZE
JOIN_SWAPGROUP
PREVIEW
PREVIEW_SIZE
PROPERTY_STATUS
REDRAW
RENDER_TIME
SET_CAMERA
SET_CAMERA_IMMEDIATE
SET_CHANGED
SET_CHANNEL
SET_KEY
SET_OBJECT
SET_PERFORMANCE
SET_SAFE_AREA
SET_TITLE_AREA
SET_VSYNC
SHOW_BOUNDING_BOX
SLEEP
SNAPSHOT
SYNC_DISPLAYS
SYNC_VIDEOINS
UNPROJECT
WINDOW_OPEN
WINDOW_OPEN_ON_PARENT
WINDOW_REPAINT
WINDOW_RESIZE
```

All possible properties on this location are shown in blue, whereas all possible commands are shown in red.

Enums are shown in purple:

```

X64 Viz Engine [1]
(verbose mode)
# send MAIN_SCENE*TREE*1*GEOM*TEXT*EDITOR*MODIFIER SET NONE
NONE SUBSCRIPT SUPERSCRIP
- Enum : set MODIFIER to the current selection

```

## Shortcuts

- **TAB:** Steps through the list of available commands or properties.
- **SHIFT + TAB:** Steps back.
- **PAGE UP** and **PAGE DOWN:** Selects the first or last entry in the active column.
- **ARROW KEYS:** Navigates through the list.
- **ENTER:** Selects the highlight possible word if shown otherwise send the command.
- **ESCAPE:** Aborts selection if shown, otherwise erase the command line.
- **SHIFT + ESCAPE:** Redraws current editing line.
- **ARROW UP/DOWN:** Shows sent commands from history.

Commands are auto converted to match correct upper or lower case. For example a *main\_scene* is turned into *MAIN\_SCENE*.

### 7.3.2 Issuing External Commands to Viz Engine via Console

External Control Applications, such as Viz Trio and Viz Pilot, communicate with Viz Engine through External Control commands. Viz Engine supports a wide range of such commands. Any installation of Viz Engine and Artist also come with the application **Viz Send**, which mimics the behavior of External Control Applications.

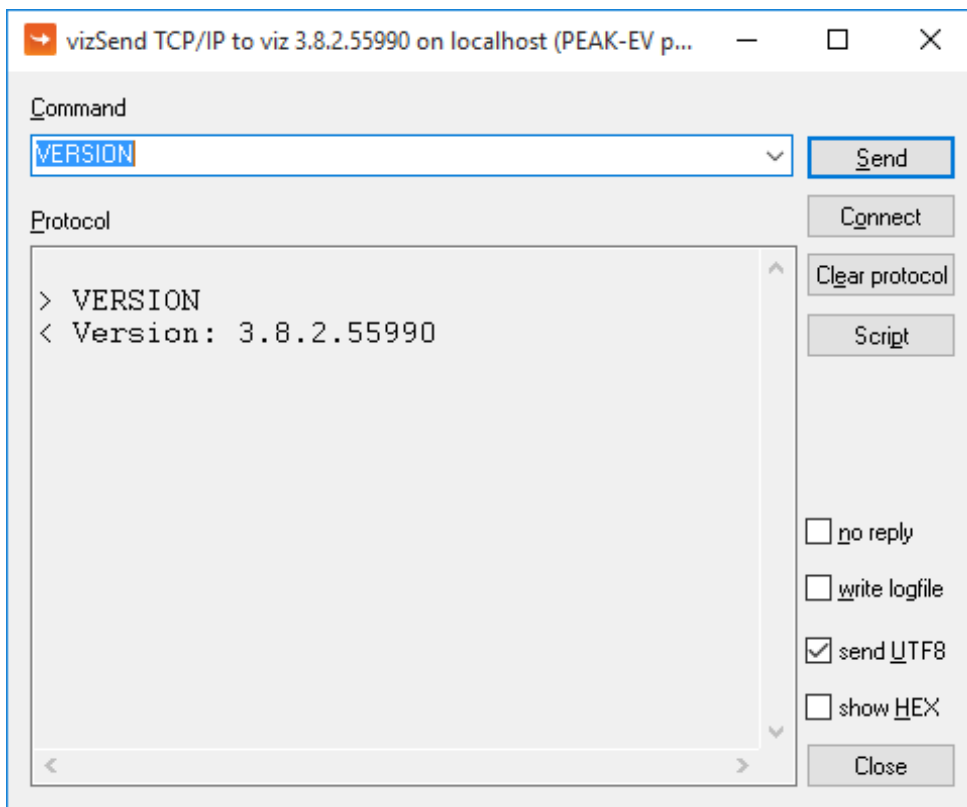

External Commands can also be sent manually to Viz Engine through the console window, using the `send` command. External commands range from loading a scene and taking the scene On Air, to shutting down Viz Engine. To issue a command to the Engine, open the console window and type `send [COMMAND]`, then press enter. For example, the command `VERSION` can be used to display the current Viz version and build number: `send VERSION` `CONSOLE: answer <Version: 3.8.2.55990>`

Most commands also have a subset of commands. All commands in the Engine follow a specific syntax, and can be passed either properties or further commands. The general syntax structure is: `[Leading flag] [Location] [Command] [Value]`

Locations and commands may also have sub-locations or subsets of commands, respectively, in which case an asterisk serves as the divider between each part. Please see the examples below for a better understanding of how to address these.

- **Leading Flag:** Define if Viz Engine should send a reply to the command being issued. A leading `-1` indicates that no reply is required. Positive integers, including `0`, serve as a command ID. This allows an external control application to match the reply to the corresponding command request, if several commands are sent simultaneously.
- **Location:** The location can be the main object, configuration, an object ID, one of the object pools, a container or geometry, a key-frame, a shared memory (SHM) location, a layer, and so on. In addition, the location can be any command or property of such. In essence, anything in Viz could serve as the location for a command. As an example, a scene can be loaded into any one of the three layers in Viz; **Back** layer, **Main** layer and **Front** layer. The layers can be addressed by name:

- `RENDERER*MAIN_LAYER`
- `RENDERER*FRONT_LAYER`
- `RENDERER*BACK_LAYER`

In addition, the scene can be accessed directly by referring to the scene via its database path, UUID, REST URL or temporary object ID:

- `SCENE*SceneLocation`
- **Command:** The Command part of the syntax can consist of either a property or another command.
- **Value:** The value for the command, which can be for example a numeric value, a location or a state.

✓ **Tip:** `COMMAND_INFO` is a very useful command, used to display help on any other command or subset. For example, passing the command `send RENDERER COMMAND_INFO` displays a list of all available properties and commands for the **RENDERER** command, while `RENDERER*BACKGROUND` displays properties and commands for the **BACKGROUND** sub-command of the `RENDERER` command.

Viz Engine can address locations in three ways, by either **UUID**, **Path** or **REST**:

- **UUID:** Universally Unique Identifiers are always provided angle brackets, for example `<1A85AC97-00AE-E74B-A236EDA262D69908>`.
- **Path:** The full path to the item, as seen in Viz Artist.
- **REST:** In addition to the built-in [Viz Engine REST Interface](#), Viz Engine also interprets Graphic Hub REST URLs as part of commands. Even though the commands themselves are case sensitive, the host names and UUIDs in REST URLs are not. The URLs may also contain special characters, like a forward slash.

These are all valid as locations when passing commands to Viz Engine, although they change the appearance of the command itself. Here is an example command setting an image as background image for the loaded scene, for each location method:

- **UUID:** `RENDERER*BACKGROUND*IMAGE*IMAGE SET IMAGE*<1A85AC97-00AE-E74B-A236EDA262D69908>`
- **Path:** `RENDERER*BACKGROUND*IMAGE*IMAGE SET IMAGE*01_DOC_EXAMPLES/Images/Bear`
- **REST:** `RENDERER*BACKGROUND*IMAGE*IMAGE SET IMAGE*http://GH\ -SERVER:19398/image/1A85AC97\ -00AE\ -E74B\ -A236EDA262D69908/Bear`

✓ **Tip:** **Object IDs** are temporary shortcuts created on the fly when an item is loaded into memory, and removed when unloading the item or restarting Viz. To get an objects Object ID, pass the **GET** command to the **OBJECT\_ID** location of the object. For example: `MAIN_SCENE*OBJECT_ID GET`.

### 7.3.3 Internal Commands

For ease of use, internal commands can be set to be hidden or visible. Under certain circumstances, some plug-ins may need to send commands on every frame. This can leave the Viz Console window flooded with text, leaving it unreadable. By default, internal commands are hidden, meaning these messages do not output to the console window. To see all internal commands by default, the Viz configuration file must be manually edited, setting `show_internal_commands` to 1. During normal operation, however, it would usually suffice to temporarily

activate the output of internal commands to the console, by clicking the  (show commands) icon in the Viz Artist or Viz Engine GUI. This also makes the console window stay on top, meaning it is not hidden behind other full-screen applications, such as Viz Artist or an Engine in [On Air Mode](#).

## 7.4 Viz Command Line Options

You can start Viz Artist and Viz Engine with various startup options. These command line parameters must be passed to the Viz executable file, `viz.exe`. The batch file `viz.cmd` is only there for compatibility reasons. The table below details the most common Viz Command Line Options. You can get a list of all available startup options, by running `viz.exe -h` or `-?` from the command line.

**✘ Important Change From Viz Engine 4:** Starting with Viz Engine version 5.0, the parsing is done according to the POSIX standard with GNU extensions. The most notable change is the space between the option character and the option argument if the option requires an argument and the required long option form for Graphic Hub parameters: `--db` instead of `-db`.

Command	Description
<code>-B &lt;path&gt;</code>	Specify the path where Viz Engine stores its temporary data (see <a href="#">Viz Engine Folders</a> ).
<code>-c</code>	Start in Viz Configuration mode (see also <code>-u 1</code> , <code>-u 2</code> , <code>-u 3</code> ).
<code>-C</code>	Start without a console.
<code>--db user:pw@server/name-server:port</code>	<p>Specify which Graphic Hub to connect to on Viz Engine startup. <code>password</code> can be omitted from the argument, but <code>user</code>, <code>server</code>, <code>name-server</code> and <code>port</code> must always be provided.</p> <div style="border: 1px solid #ccc; padding: 5px; margin: 5px 0;"> <p><b>📘 Example:</b> <code>viz.exe --db Guest:@VizDbServer/localhost:19396</code></p> </div> <p>In the example above, Viz Engine connects to a Graphic Hub server called <code>VizDbServer</code> (⚠️ case sensitive) on the name-server <code>localhost</code> at port <code>19396</code>, as the user <code>Guest</code> with no password.</p>
<code>-g &lt;config file&gt;</code>	Start with a predefined Viz Config file. This allows a User to have more than one startup option.

Command	Description
-G 1, -G 2, -G n	<p>Sets the GPU affinity for the selected instance. For systems with two or more graphic cards (Viz Trio One Box / Dual Channel). See <a href="#">Systems with Two or More GPUs</a> below.</p> <div style="border: 1px solid #ccc; padding: 10px; margin-top: 10px;"> <p><b>i Example:</b>  <i>viz.exe -u 1 -y -n -G 1</i> starts Viz Engine with On Air GUI as first instance, bound to the first GPU.  <i>viz.exe -u 1 -y -n -G 2</i> starts Viz Engine with On Air GUI as first instance, bound to the second GPU.</p> </div>
-h, -?	Display the available commands.
-i	Enable pre-initialization of textures. Textures are generated on the graphics card immediately after loading an image.
-l	Specify a console title to distinguish Viz Engines in a Dual Channel setup (example: <code>-l &lt;title&gt;</code> ).
-M	Used by Viz Trio to allow sharing of content between Viz Artist and Viz Trio.
-n	Start in Viz Engine mode (see also -u 1, -u 2, -u 3).
-o "<scene>" -o "<layer> <scene>"	<p>There is also an optional argument may give a scene that is loaded upon startup with the following syntax:</p> <p><b>SCENE*scene_id</b> ... load scene_id into the main layer  <b>1 SCENE*scene_id</b> ... load scene_id into the main layer  <b>0 SCENE*scene_id</b> ... load scene_id into the back layer  <b>2 SCENE*scene_id</b> ... load scene_id into the front layer</p>
-P	Disable automatic mouse capture.
-t	Enables non-interactive mode for all occurrences except dongle issues and sound driver setup. The non interactive mode was introduced for use cases where there is no user and when there is no GUI one can interact with.
-T	Keep the Viz Engine Console always on top.
-u 1, -u 2, -u 3 (up to a maximum of 24)	Sets the instance number.

Command	Description
-v [argument]	Enable verbose mode. This enables all possible information to be shown in the Viz Engine Console.  The optional argument is a number composed by addition of: <ul style="list-style-type: none"> <li>• <b>1</b>: produce verbose output to console</li> <li>• <b>2</b>: add a timestamp</li> <li>• <b>4</b>: log OpenGL</li> <li>• <b>16</b>: log 2d-texture messages</li> <li>• <b>32</b>: log Graphic Hub related debug messages</li> <li>• <b>64</b>: log medium and high GL warnings</li> </ul>
-w	Start in Engine mode and show render window (videowall mode).
-W	Disable restart on crash.
-X	Write extended dump file (full memory dump) in case of a program crash.
-y	Start in Artist mode. Viz Artist is stated by Viz Engine after the Engine has started.
-Y <path>	Specify the path where Viz Engine stores its program data (see <a href="#">Viz Engine Folders</a> ).

### 7.4.1 Systems with Two or More GPUs

It is possible to specify which GPU Viz Engine should run on, by providing the flags `-G n`, whereas `n` means the index of the GPU (starting with 1). In combination with the `-u` flag, it is possible to start Viz on a dedicated GPU, no matter, where the primary monitor is connected to.

Providing the `-G` parameter is mainly used to bind certain instances to dedicated GPUs or to make sure, that a GPU is not occupied by any Viz Engine instance.

#### Example:

`viz.exe -u 1 -y -n -G 1` starts Viz Engine with On Air GUI as first instance, bound to the first GPU.

`viz.exe -u 2 -n -G 2` starts Viz Engine as second instance with console only, rendering on the second GPU.

`viz.exe -u 2 -n -G 1` starts Viz Engine as second instance with console only, but rendering on the first GPU.

If only the `-u` parameters are provided, Viz uses the old behavior by automatically assigning the GPU to the instance started.

Formula: `m%n`, where:

- `m` = `-u 1/-u 2/etc.`
- `n` = number of GPUs

For example, with two Viz Engines:



- System with two GPUs: Engines run on GPU2: Engine 1 (-u 2) / Engine 2 (-u 4)
- System with three GPUs: Engines run on GPU2: Engine 1 (-u 2) / Engine 2 (-u 5)

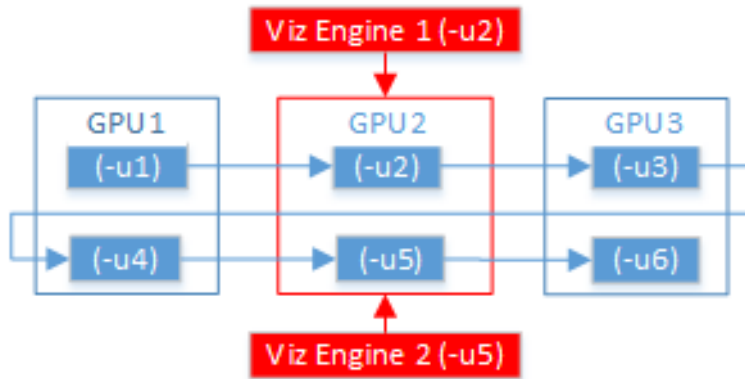

When either Viz Trio One Box or Dual Channel Viz Artist versions are installed, GPUs are selected by default.

## 8 Configuring Viz

This page contains information on the following topics:

- [Working with Viz Configuration](#)
  - [To Start Viz Configuration](#)
- [Modify Viz Configuration](#)
  - [To Save the Current Configuration](#)
  - [To Reset the Viz Config File](#)
  - [To Restart Viz Configuration](#)
- [Installed Configuration Profiles](#)
  - [To Load a Pre-Installed Configuration Profile](#)
  - [To Save a Custom Profile](#)
  - [To Load a Custom Configuration Profile](#)

Viz Configuration is the configuration interface for Viz Engine and other applications that integrate with Viz Engine.

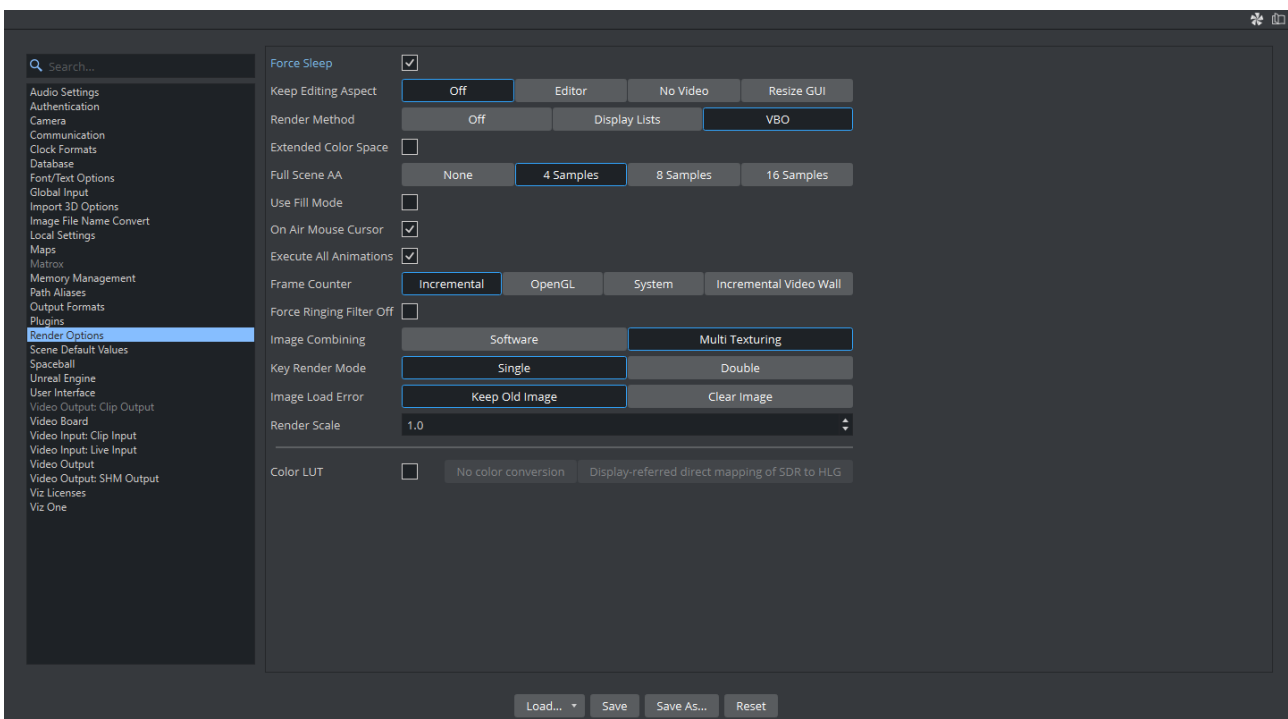

The Viz Configuration user interface is divided in two parts:

- **Sections:** Shows a list of all the sections available for configuration.
- **Configuration Parameters:** Shows all available configuration parameters for each section.

Various parameters regarding the program functionality can be set in the configuration. Viz Artist/Engine is mainly configured with the Viz Configuration. All configuration settings are stored in a Viz Config file (located in the *<viz data folder>*).

Any changes to the host name affects the configuration.

If required, an optional Viz Config file can be reassigned with the command `-g <configuration file>`.

 **Caution:** Make sure that any changes are saved before Viz Configuration is closed. Changes are not saved and do not take effect until Viz Artist has been closed and started again.

## 8.1 Working With Viz Configuration

To configure Viz Artist and Engine, click the **Config** button in Viz Artist or start the Viz Configuration application from the Start menu. Viz Artist/Engine also has a selection of Installed Configuration Profiles. When the configuration profiles are saved, only the settings that differ from the default configuration of a setup (VGA mode, Video mode, etc.) is saved.

Viz Configuration adjusts its size to the current screen resolution when it opens. When running Viz Configuration without Viz Artist, it checks the resolution and limits the size to 1430 x 750 pixels. This is useful for high-resolution configurations, especially during [Video Wall Configuration](#).

### 8.1.1 To Start Viz Configuration

- Run Viz Configuration from the desktop shortcut or the **Start** menu.
- If Viz Artist is running, click **Config** or press **F11**.

## 8.2 Modify Viz Configuration

This section details how to Save, Save as..., Reset and Load Viz Configurations.

### 8.2.1 To Save the Current Configuration

1. Start Viz Configuration.
2. Change the configuration as required.
3. Click **Save**.

 **IMPORTANT!** Changes made to the resolution can affect an in use IP streaming service. Make sure to check the IP streaming service configuration.

4. Click the **Restart** button to apply the saved changes. The Viz Config file is updated.

### 8.2.2 To Reset the Viz Config File

The **Reset** button sets the configuration to default settings.

1. Start Viz Configuration.
2. Click **Reset**.
3. Click **Restart** to apply the changes.

### 8.2.3 To Restart Viz Configuration

Click the **Restart** button to save changes.

1. Click **Restart**.
  2. Select from:
    - Current
    - Viz Engine w/GUI
    - Viz Engine w/o GUI
    - Viz Artist
    - Viz Config
- 

## 8.3 Installed Configuration Profiles

Viz Artist/Engine is installed with a selection of Configuration Profiles. These profiles are a set of predetermined basic settings to run Viz Artist/Engine for specific purposes, for example, [Dual Channel Mode](#), [Trio Box CG Mode](#) or a [Video Wall Configuration](#).

Once loaded into the Viz Configuration, these files can be modified to refine the profile to specific needs, which can then be saved. Pre-installed Configuration Profiles are located in: `<viz install folder>\Configuration Profiles`.

### 8.3.1 To Load a Pre-Installed Configuration Profile

1. Start Viz Configuration.
2. Click **Load** and select **Installed Profile**. The correct folder opens automatically.
3. Open the required Configuration Profile.
4. Click **Restart** to load the Configuration Profile.

### 8.3.2 To Save a Custom Profile

A Configuration Profile cannot be saved to the `<viz install folder>`. A UAC requirement is that an application must not write to the installation folder (see [User Account Control](#)). The default location for custom Configuration Profiles is `%Programdata%\Vizrt\VizEngine\Configuration Profiles`.

1. Start Viz Configuration.
2. Change the configuration as required.
3. Click **Save As**.
4. Select a location to save the new Configuration Profile. The default location is `%Programdata%\vizrt\VizEngine`.
5. Type a name for the new Configuration Profile.
6. Click **OK**.

### 8.3.3 To Load a Custom Configuration Profile

1. Start Viz Configuration.
2. Click **Load** and select **Custom Profile**. The correct folder opens automatically.
3. Locate a saved Configuration Profile (\*.cfg).
4. Open the required Configuration Profile.
5. Click **Restart** to load the saved Configuration Profile.

## 8.4 Audio Settings

This section provides information about the following:

- [Various Tab](#)
- [Channels Tab](#)
  - [To Add Multi-language Audio Channels](#)
  - [To Add Multiple Audio Channel Configurations](#)
  - [Setup Tab](#)
- [Manual Audio Configuration](#)
  - [To Map Audio Output for a Dual Channel Setup](#)
  - [To Manually Activate an Audio Device](#)

### 8.4.1 Various Tab

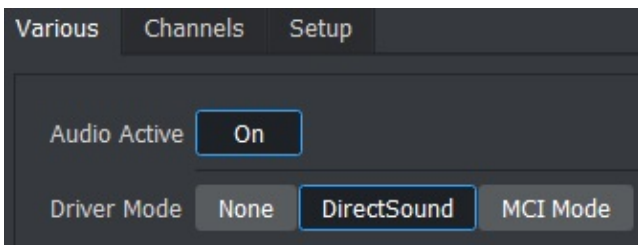

- **Audio Active:** Toggles audio in Viz Engine on/off.

On videoboard enabled system the following settings are also available:

- **Ring Buffer Delay:** Makes the audio system compensate for the ringbuffer delay during clip playout. Ringbuffer is ignored when disabled.
- **Mute On Scene Load:** Mutes audio before any scene load commands are executed when set to **On**. This is necessary for video cards which do not mute the audio automatically, or when no video refresh happens.

**Note:** Additional commands to mute audio can be added in the Viz Config file.

- **Driver Mode:** Affects playback of sound on the computer running Viz Engine, for audio monitoring purposes.
  - **None:** Prohibits Viz Engine from playing out sound on the local system.
  - **DirectSound:** Uses DirectSound drivers (requires DirectX). This is the recommended driver.
  - **MCI Mode:** Uses MCI driver mode, for systems where DirectSound is either not available or performs unsatisfactorily.

## 8.4.2 Channels Tab

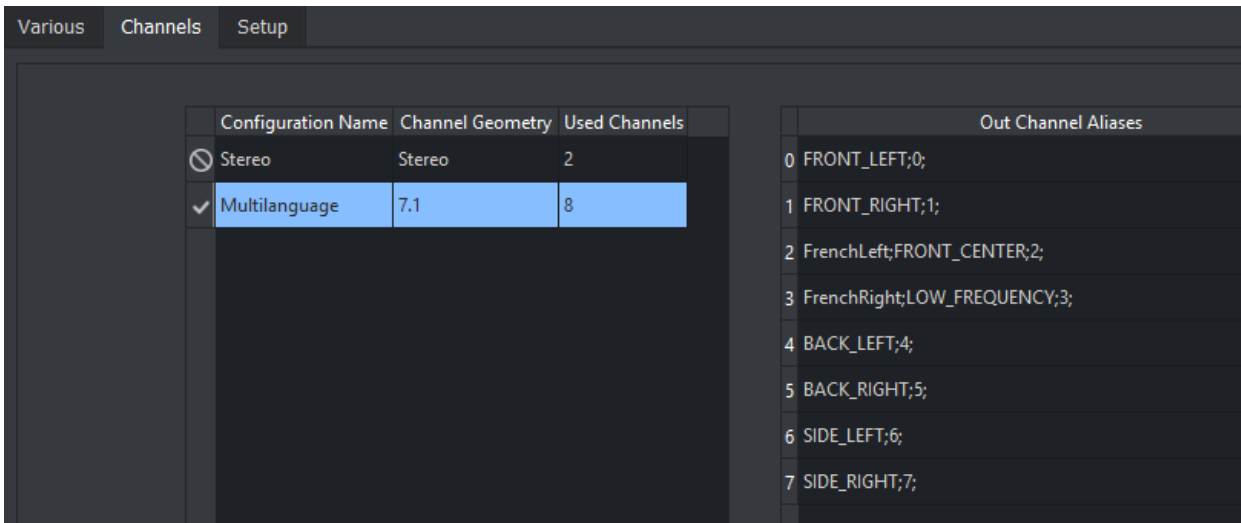

- **Configurations:** Shows a list of channel configurations.
- **Add:** Adds a new channel configuration to the Configurations list.
- **Delete:** Deletes the selected channel configuration from the Configurations list.
- **Name:** Sets the name of the selected channel configuration.
- **Channel Geometry:** Sets the channel geometry. Options are:
  - Mono
  - Stereo
  - 5.1
  - 7.1
  - Quad
- **Used Channels:** Sets the number of configurable channel alias fields that can be mixed by the internal channels in Viz Engine (software). On a Matrox system this number must be equal to the number of configured input channels (hardware). This setting is independent of the Channel Geometry setting.
- **Reset Aliases:** Sets the channel aliases to the default option (the custom entry is not removed).
- **Out Channel 0-15:** The Out Channels represent the internal Viz audio channels, which are mixed to the output device one by one. Alias names are useful to create multilingual systems, and also to define the channel geometry for the Default and FX audio clip mix modes. Aliases are separated by a semicolon. The **Audio** plug-in only uses the channel aliases to find the correct speakers for Pan and 3D sound effects in FX mode. With this functionality any of the 16 internal audio channels can be used to play any audio geometry.

### To Add Multi-language Audio Channels

1. From the Channels tab, click **Insert**.
2. Enter the new name in the **Name** field.
3. Set the Channel Geometry to **Stereo**.
4. Set the number of **Used Channels** to, for example, **4**.
5. In the **Channel 2** field, add the alias **FrenchLeft**.

- In the **Channel 3** field, add the alias **FrenchRight**. Add the same configuration for English (EnglishLeft, EnglishRight) and German (GermanLeft, GermanRight) on the other machines.
- Click **Save**.

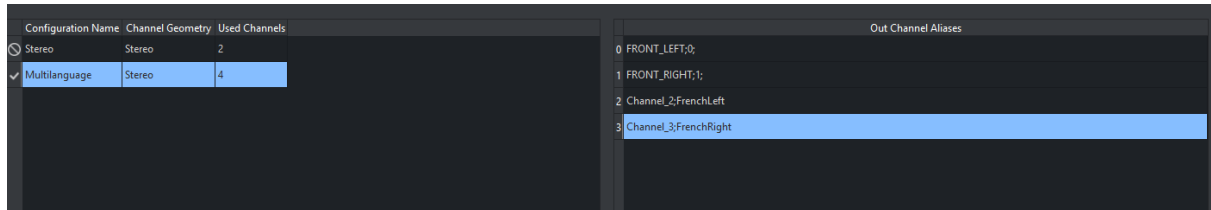

## To Add Multiple Audio Channel Configurations

- Repeat [To Add Multi-language Audio Channels](#) to add three more Multi-language Audio Channels. Name the configurations the following way:
  - Multi-languageF**
  - Multi-languageE**
  - Multi-languageG**
- Add a **Multi-languageAll** configuration.
- In the **Channel 1** field, add the aliases **FrenchLeft, EnglishLeft and GermanLeft**.

```
FRONT_LEFT;
Channel_0;FrenchLeft;EnglishLeft;GermanLeft;
FRONT_RIGHT;
Channel_0;FrenchRight;EnglishRight;GermanRight;
```

- In the **Channel 2** field, add the aliases **FrenchRight, EnglishRight and GermanRight**.
- Click **Save**.

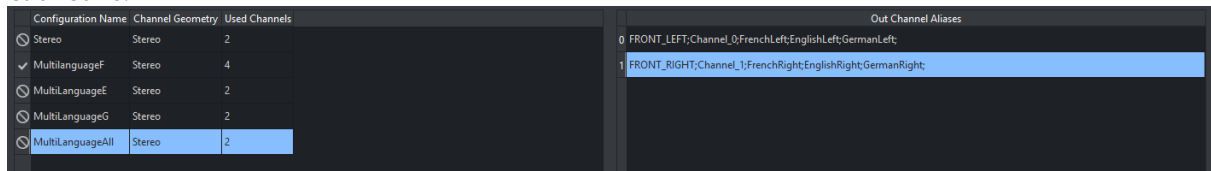

## Setup Tab

The Setup tab lists all available audio devices available to the Viz Engine audio mixer (see [Audio in Viz](#)). All devices listed with **Device0** are DirectSound compatible devices installed on the system. **Device0** is always the default playback device, configurable through **Sound** options in the Windows system **Control Panel**.

When a Matrox card is installed, Matrox audio is available. With Matrox audio, there are different ways to capture audio for use with the Viz Engine audio mixer, before it is output:

- Capture audio embedded in the live video input signal from the live input connectors.
- Capture audio from the AES connectors.

The final output is the same, either embedded as part of the live video output signal, or separated out to the AES output connectors. In addition, simply loop audio through the system. This makes the embedded or AES audio unavailable to the Viz Engine audio mixer.

The **Default** mode captures audio and directs it to the default onboard audio device with no output on the Matrox card output connectors.

**Note:** The Matrox audio-extension board is not configurable through this user interface.

Various		Channels	Setup
			Device Name
Device0			Headset Earphone (Logitech Stereo H650e)
Device1			Speaker (Conexant ISST Audio)
Device2			none

- **Device *n*** : Shows the name of the audio card.
- **Mode:** Refers to the audio mode of the Matrox board. Options are:
  - **Embedded:** Captures audio from the Live video input connectors and is made available to the Viz Engine audio mixer, to mix it with other audio sources. Then output as embedded audio on the live video output connectors.
  - **AES:** Captures audio from the AES input connectors and is made available to the Viz Engine audio mixer, to mix it with other audio sources. Then output on the AES output connectors.
  - **Embedded -> AES:** Captures embedded audio from the live video input connectors and is made available to the Viz Engine audio mixer, to mix it with other audio sources. Then output on the AES output connectors.
  - **AES -> Embedded:** Captures audio from the AES input connectors and is made available to the Viz Engine audio mixer, to mix it with other audio sources. Then output as embedded audio on the live video output connectors.
  - **Loop:** Loops audio through. No audio is mixed.
  - **Default:** Captures audio, but no output on the Matrox card.

### 8.4.3 Manual Audio Configuration

Certain use-cases require manual configuration of audio. Make sure to create a backup of the Viz configuration file before performing the following procedures:

#### To Map Audio Output for a Dual Channel Setup

1. In a Dual Channel environment there are two Config files, one for each Viz Engine.
2. For the first Viz Engine (1) the configuration of the audio output channel mappings should look like this:

```
Matrox0.AudioOut1.MapToVizChannel = 0
Matrox0.AudioOut2.MapToVizChannel = -1
```

3. Note that the audio output for the first Viz Engine (1) should be according to the video output channel:



```
Matrox0.VideoOut1.MapToVizChannel = 0
Matrox0.VideoOut2.MapToVizChannel = -1
```

- For the second Viz Engine (2) the configuration should look like this:

```
Matrox0.AudioOut1.MapToVizChannel = -1
Matrox0.AudioOut2.MapToVizChannel = 0
```

 **Note:** In a stereo setup, audio must be set to `Off` in the second Viz Engine (2).

- Mind the difference to the video output settings:

```
Matrox0.VideoOut1.MapToVizChannel = -1
Matrox0.VideoOut2.MapToVizChannel = 0
```

- All other audio output channels should be set to `Off` :

```
Matrox0.AudioOut3.MapToVizChannel = -1
Matrox0.AudioOut4.MapToVizChannel = -1
```

## To Manually Activate an Audio Device

- Open the Viz Config file.
- Go to **SECTION AUDIO\_CONFIG** and locate the **Available0** setting.
- Activate the identified audio device (**Available0**) by adding its name to the **AudioDevice0** setting. For multiple outputs, more than one device can be added as AudioDevice1, AudioDevice2 and so on.
- Save the Viz Config file.

 **Example:** `AudioDevice0 = Realtek HD Audio output`

## 8.5 Authentication

The Authentication panel is for the authentication of one or more [Viz One](#) systems on Viz Artist. Enter the details of each Viz One system to connect to. To save a new user, all three panels of the Authentication panel must be completed. If a Realm is not required, enter `<empty>` in the Realm panel. If only one or two panels are completed, the information is not saved.

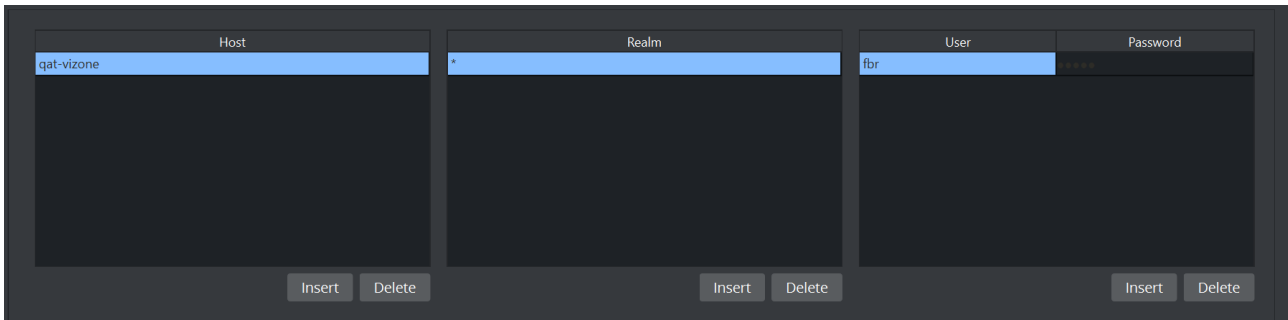

- **Host Info:** The host name of the Viz One server.
- **Realm:** Determines if an entry should be used in an authentication process for a given URI.
- **User Info:** Name and password for each User, for the selected Host and Realm.

### 8.5.1 Authentication Properties

#### Host Info Properties

The host name of the Viz One server (see also [Fsmon \(File System Monitor\)](#)). The host info is in the form '`host:port`', where the colon and port number are optional. An asterisk value ( `*` ) shows that it is used against all hosts. The host info can be the Viz One host name or IP address.

#### **i** Examples:

- Host Info = `myhost.mycompany.com:8080`
- Host Info = `10.0.1.2:8080`
- Host Info = `*`

- A Host cannot be added without at least one Realm (or an empty Realm with `<empty>` entered) and one User defined.
- A Host can have more than one Realm.

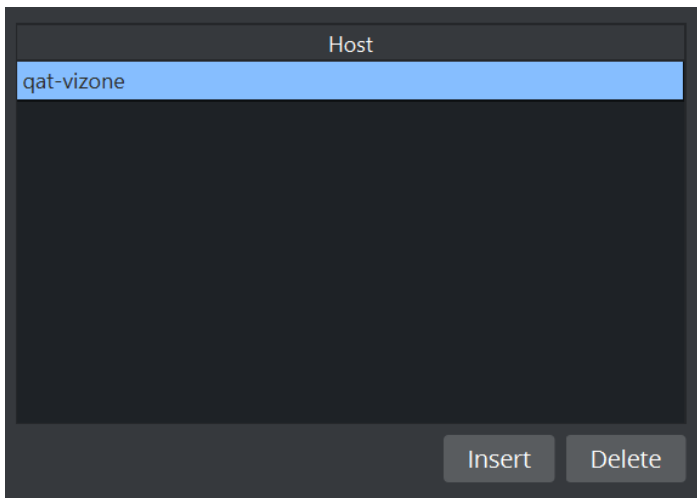

- **Insert:** Adds a host name. To change, double click on the entry.
- **Delete:** Removes a selected host name.

**Note:** Do not enter a URL as the Host Info name. The Host Info name format must be `host[:port]`, for example: `vizone.mycompany.com:8080`.

## Realm Properties

Determines if an entry should be used in an authentication process for a given URI.

**Example:** A single value of shows that it should be used against all realms (Realm = `[a-zA-Z_0-9]` or `'*'`).

- A Realm cannot be added to a Host without at least one User defined
- A Realm can have more than one User.

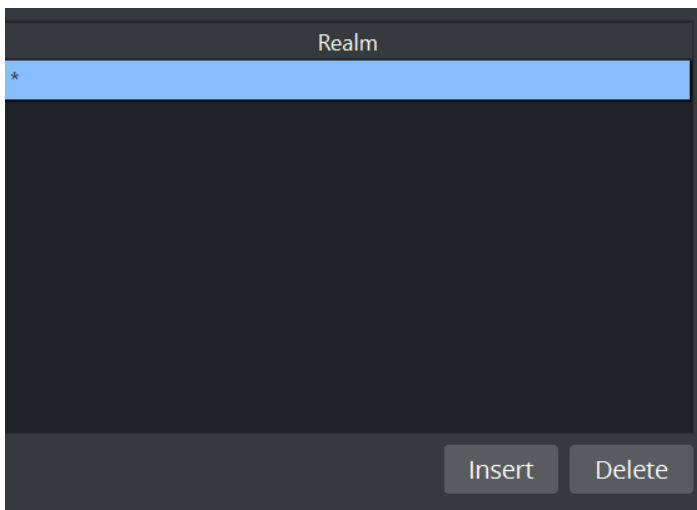

- **Insert:** Adds a Realm. To change, double click on the entry.
- **Delete:** Removes a selected Realm.

- **Realm:** Displays the name of the required Realm.

## User Info Properties

Name and password for each user, for the selected Host and Realm. Passwords are not mandatory.

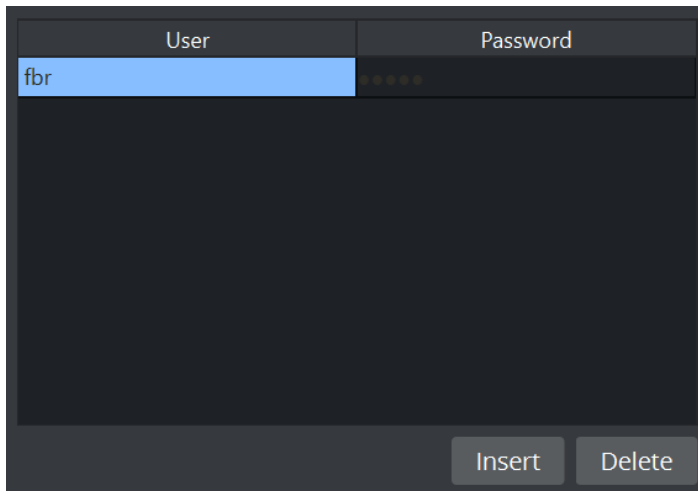

User	Password
fbr	••••••

Insert Delete

- **Insert:** Adds a user. To change, double click on the entry.
- **Delete:** Removes a selected user.
- **User:** Enter the user name.
- **Password:** Enter a password for the user, if required.
- **Confirm PW:** Confirm the user password.

### See Also

- [Viz One Configuration Panel](#)

---

## 8.6 Camera

In the Camera section, special camera behavior settings which are used for virtual studio setups, can be set. Viz Tracking Hub is used as the studio configuration and calibration tool for enabling connectivity and control between all required studio devices such as cameras, routers, VTRs, video servers, audio mixers and other studio equipment.

 **Note:** Tracking Hub and Studio Manager are the successors of VizIO. VizIO is not supported since Viz Engine version 4.0. To enable Tracking Hub, set the flag `use_trackinghub` to `1`, section CAMERA.

## 8.6.1 Camera Properties

Virtual Studio

---

On Air Camera

On Air Camera ▼

Stereo Mode Off ▼

Depth of field All from external ▼

---

Camera 1 ▼

---

Distortion Mode Auto ▼

Parameter Mode Auto ▼

---

Distortion

K1 ▼

K2 ▼

---

Chip size X ▼

Chip size Y ▼

---

Center shift X ▼

Center shift Y ▼

---

Camera 1 ▼

---

Virtual Window

FoV Add 0.0 ▼

FoV Scale 1.0 ▼

- **Virtual Studio:** Starts the tracking process when Viz Engine is started when set to **Active**.

- **On Air Camera:** Activates the selected camera that should be used when setting the scene in **On Air** mode. The camera is controlled by an external tracking device.
- **Stereo Mode (Classic Render Pipeline only):** (Stereo Mode settings only take effect when the design is taken On Air - license required):
  - **Off:** Makes Stereo mode unavailable and invisible in the GUI **Camera Editor**.
  - **Quad Buffered:** Alternates the image for the left/right eye and darkens the other eye when using nVision glasses together with a monitor with a frequency >100Hz. This configuration provides the full resolution.
  - **Over Under Left Top/Over Under Right Top:** Draws both images beneath each. Either side can be drawn first. The image height is halved, providing half resolution.
  - **Left Eye/Right Eye:** Renders either the left or right eye image for dual-channel setups in combination with a Video Wall / Stereo Distributor. Full resolution.
  - **Side By Side Left/Side By Side Right:** Renders both images side by side, either left or right first. The image width is halved, providing half resolution.
- **Depth of field:** Defines from where parameters are taken:
  - **Use editor:** Gets parameters for depth of field from the editor.
  - **Focal plane from external:** Gets only the focal plane from the external camera.
  - **All from external:** Gets all parameters from the external camera.
- **Distortion:** Here you can set the lens distortion parameters for each camera individually.
  - **Camera:** Sets the camera number.
  - **Distortion mode:** Sets the preferred distortion depending on the tracking system which is used. Available distortion modes are:
    - **Auto**
    - **Internal**
    - **Libero**
    - **Xpecto**
    - **Radial**
    - **Stype**
    - **Trackmen**
    - **ImageBased**
  - **Parameter mode:** Set the parameter for the lens distortion, depending on the tracking system which is used:
    - **Auto**
    - **Libero**
    - **Manual**
    - **Tracking Hub**
- **Virtual Window:** Additional settings for Virtual Window.
  - **Camera:** Determines the camera to use.
  - **FoV Add:** Sets an offset of degrees to the tracking data.
  - **FoV Scale:** Scales the incoming FoV tracking data.

#### See Also

- **Advanced Lens Distortion** in the [Viz Artist User Guide](#).

## 8.7 Clock Formats

Format 1	hh:mm:ss	Format 11	
Format 2	h:mm:ss	Format 12	
Format 3	hh:mm	Format 13	
Format 4	h:mm	Format 14	
Format 5	hh:mm:ss.dd	Format 15	
Format 6	sss.dd	Format 16	
Format 7	ssss	Format 17	
Format 8	m:ss.dd	Format 18	
Format 9	dddd	Format 19	
Format 10	mm:ss	Format 20	

In this section, twenty various digital date and time formats can be set. Viz Engine distinguishes between uppercase and lowercase clock formats, allowing for even more customization options. Setting the clock format using lowercase letters forces Viz Engine to display the digit even if the value is 0. By defining the clock format using uppercase letters, Viz Engine omits the value if it is zero. This allows the designer to omit unused digits while still planning for their use when designing the scene.

- **Format 1-20:** Sets and enables the clock formats that may be selected in Viz Artist during scene design.

✓ **Tip:** Add a font GEOM in Viz Artist to see how the clock formats can be used.



## 8.8 Communication

In this section, network connections can be set. External control software, for example, Viz Trio, uses TCP/IP network connections to send commands to the Viz Engine renderer engine (some external communications are also through UDP). Viz Artist expects the commands at the ports which are defined here. The Communication panel has four tabs, Global, Shared Memory, VDCP (Video Disk Control Protocol) and Unreal Communication.

- [Global Properties](#)
- [Shared Memory Properties](#)
  - [To Limit the Number of TCP Connections](#)
- [VDCP Properties](#)

### 8.8.1 Global Properties

Global	Shared Memory	VDCP
General Communication Port	6100	
Additional Communication	<input checked="" type="radio"/> None <input type="radio"/> UDP <input type="radio"/> Udp and Multicast	
Udp and Multicast Port	6100	
Multicast IP Address	224.1.1.1	
Enable GPI	<input type="checkbox"/>	
MUX Isolated Port	50007	
MUX Shared Port	50008	
MUX Fixed Port	50009	
Still Preview Port	50010	
Multi Touch Input	<input checked="" type="radio"/> Server UDP <input type="radio"/> Mouse <input checked="" type="radio"/> Windows Touch <input type="radio"/> TUIO <input type="radio"/> Win Stylus	
Multi Touch Port		
Multi Touch IP Address		
TUIO Port		
Display Diagonal (inches)	27.0	
Display Aspect Ratio	1.778	
Frame Accurate config Comm.	<input type="checkbox"/>	
FAVC Bias		
Command Field Dominance	<input checked="" type="radio"/> Always <input type="radio"/> Execute always <input type="radio"/> Even Retrace Counter <input type="radio"/> Intern. Always / Extern. Odd <input type="radio"/> Intern. Always / Extern. Even	
On Air Mouse Events	<input checked="" type="checkbox"/>	
REST Webservice	0	<input type="button" value="Install"/> <input type="button" value="Uninstall"/>
Enable Logging	<input type="checkbox"/>	
GFX Port	55000	
Super Channel Port	56000	

- **General Comm. Port:** Sets the general communication port for receiving external commands when in [On Air Mode](#). Make sure to update settings on the client side if you change the default port. The default is port `6100` (TCP).
- **Additional Communication:** Enables sending of commands to Viz Engine on **UDP** and **Multicast**, or a combination of the two.
- **Udp&Multicast Port Number:** Sets the port number for the computers that share the same virtual IP address.
- **Multicast IP Address:** Sets the shared virtual IP address.

 **Note:** The default maximum number of TCP connections is limited to 255. Within this number of connections, a user defined limit of maximum connections can be set.

- **Enable GPI:** Enables initialization of supported Sealevel GPI/O devices when Viz Engine starts.
- **MUX Isolated Port:** Sets the port number for isolated sessions - no shared data (NLE).
- **MUX Shared Port:** Sets the port number for shared sessions - shared data (NLE).
- **MUX Fixed Port:** Sets the port number for fixed sessions - shared data, no reference counting (NLE).
- **Still Preview Port:** Sets the port number for still preview.
- **Multi Touch Input**
  - **Server UDP:** Multi Touch events are retrieved from the Viz Multi Touch Interface (see protocol documentation, Viz MultiTouchServer). An external server application connects to the touch device, translates the hardware messages into the Viz Multi Touch Protocol, and sends it via UDP to Viz Artist or Viz Engine. This triggers the internal Multi Touch events in scripts utilizing the plug-in API.
  - **Mouse:** Enable this to use a standard mouse to test Multi Touch trigger callbacks.
  - **Windows Touch:** Viz Artist and Viz Engine use Windows Touch messages to generate Multi Touch events.
  - **TUIO:** (Tangible User Interface Object) Select this if the touch device and/or application works with TUIO/OSC (Open Sound Control).
  - **Win Stylus:** Activates stylus pen input.
- **Multi Touch Port:** Sets the port number where Viz Engine listens for the multi touch server. Required for Server UPD communication.
- **Multi Touch IP Address:** Sets the IP address where Viz Engine listens for the multi touch server. Viz Artist and Viz Engine send keep-alive messages to the Multi Touch Server. You need to enter the IP address of this server. Required for Server UPD communication.
- **TUIO Port:** Sets the TUIO (Tangible User Interface Object) port number to communicate with a TUIO enabled multi-touch device. TUIO is a protocol for Table-Top Tangible User Interfaces. The default port for most TUIO applications is `3333`.
- **Display Diagonal (inches):** Viz Artist and Viz Engine can calculate transformations with momentum. For this, it needs to know the real, physical, screen-dimension to calculate the correct animation speeds. The value is in inches. Used for gesture recognition.
- **Display Aspect Ratio:** The real aspect ratio of the screen is required, as some screens do not have pixel aspect ratios of `1.0`. Used for gesture recognition.
- **Frame Accurate config. Comm.:** Frame accurate commands through TCP (commands delayed by ringbuffer and specified FAVC bias). Enable only for external control that supports special frame accurate command execution. Used with [Frame Accurate Output](#).

- **FAVC Bias:** Defines delay in fields, in addition to ringbuffer size, for frame accurate commands via TCP or GPI. This is the bias in frames for the commands, if **Frame Accurate Viz Communication.** is set to **On** . Allows negative values.
- **Command Field Dominance:** States when to handle the commands sent to Viz Engine. For example, when set to **Odd Retrace Counter** , Viz Engine handles all commands on odd fields. Not valid in progressive video output modes. Options are:
  - **Always.**
  - **Odd Retrace Counter:** Executes commands at an odd retrace counter.
  - **Even Retrace Counter:** Executes commands at an even retrace counter.
  - **Intern. Always/Extern. Odd:** Executes commands internally always and externally at an odd retrace counter.
  - **Intern. Always/Extern. Even:** Executes commands internally always and externally at an even retrace counter.
- **On Air Mouse Events:** Sets mouse events in **On Air Mode** to **On** or **Off** .
- **REST Webservice:** Sets the port number for communication with the **Viz Engine REST Interface**. The default is **0** , which deactivates the Webservice.
  - **Install:** Sets the port number and click **Install** to install the Webservice.
  - **Uninstall:** Removes the Webservice.

 **Note:** To view the current documentation for the REST interface, go to `http://localhost:<port number>/#/documentation`.

 **IMPORTANT!** The Webservice does not automatically install when **User Account Control** is active. Click **Install** to activate the Webservice.

- **Enable Logging:** Enables Webservice logging to the Viz Console.
- **GFX Port:** Sets the GFX Channel starting port number (GFX2: GFX Port+1, GFX3: GFX Port+2. For example: `55000` , `55001` , `55002` , etc.).
- **Super Channel Port:** Sets the Super Channel starting port number (SUPERCHANNEL2: Super Channel Port+1, SUPERCHANNEL3: Super Channel Port+2. For example: `56000` , `56001` , `56002` , etc.).

## 8.8.2 Shared Memory Properties

The screenshot shows the 'Shared Memory' configuration page. It includes the following settings:

- Multicast IP Address:** 224.2.2.2
- Multicast Port:** 0
- Udp Port:** 0
- Tcp Port:** 0
- Debug:** Off
- Master Engine IP Address:** (empty)
- Master Engine Port:** 0
- Master Poll:** Inactive (selected), Commands, UDP, TCP

- **Multicast IP Address:** Sets the address for synchronizing distributed shared memory map without a Graphic Hub.
- **Multicast Port:** Synchronizes shared memory between all Viz Engines listening to the multicast.
- **UDP Port:** Sets the UDP listening port for the shared memory input.
- **TCP Port:** Sets the TCP listening port for the shared memory input.
- **Debug:** Enables Shared Memory logging for UDP and TCP communication. Use Verbose to enable smm logging level with additional connection information.
- **Master Engine IP Address:** Sets the IP address of the master Viz Engine which holds the complete shared memory map (loaded during startup of Viz Engine).
- **Master Engine Port:** Sets the initializing port for the shared memory on startup (the command port of the master Viz Engine).
- **Master Poll:** Makes a Viz Engine load the shared memory map from the master Viz Engine, through the selected communication protocol. Available options are:
  - **Inactive**
  - **Commands**
  - **UDP**
  - **TCP**

## To Limit the Number of TCP Connections

Since Viz Engine 3.3, the number of TCP connections to Viz Artist can be set in the Viz configuration. The maximum number of TCP connections is limited to 255. If set to `1`, the first control application connecting to Viz Artist/Viz Engine gets exclusive control over Viz Artist/Viz Engine.

1. Open the Viz Config file.
2. Under **SECTION COMMUNICATION** set ' `max_tcp_connections` ' to the number of TCP connections required.

This setting applies to the default port ( `6100` ) and the Multiplexing Ports.

### 8.8.3 VDCP Properties

The VDCP (Video Disk Control Protocol) tab enables the configuration of up to eight external controllers which can then have basic control over clip-channels and render-layers (Front, Main, Back).

	Global	Shared Memory	VDCP				
	Enable	Protocol	Port	Mode	ID	Layer	
Controller 1	<input type="checkbox"/>	Serial		Layer		Back	
Controller 2	<input type="checkbox"/>	Serial		Layer		Back	
Controller 3	<input type="checkbox"/>	Serial		Layer		Back	
Controller 4	<input type="checkbox"/>	Serial		Layer		Back	
Controller 5	<input type="checkbox"/>	Serial		Layer		Back	
Controller 6	<input type="checkbox"/>	Serial		Layer		Back	
Controller 7	<input type="checkbox"/>	Serial		Layer		Back	
Controller 8	<input type="checkbox"/>	Serial		Layer		Back	

Basic control is the ability to set a clip and to start, stop, pause or continue playback of a clip, or the scene animation in the specific layer.

- **Controller <1 to 8>:** Configure up to eight external controllers. Each Controller has these parameters:
  - **Enable:** Makes the Controller connection Active or Inactive.
  - **Protocol:** Selects a protocol (TCP/IP or Serial connections) for the external control device.
  - **Port:** Sets a port number where an external VDCP client can connect to the specified VDCP controller of the Viz Engine.
  - **Mode:** Select a mode:
    - **Clip Channel:** Enables the control of a selected video clip channel.
    - **Layer:** Enables the control of animation in a layer.
  - **ID:** Selects a Clip channel (an ID between `1` and `16` ) to control. Available if **Mode** is set to **Clip Channel**.

- **Layer:** Selects the layer. Available if **Mode** is set to **Layer**. Available options are **Back**, **Main** or **Front**.

**See Also**

- [Viz Engine Shared Memory](#)
- **VizCommunication.Map** (see the [Viz Artist User Guide](#))

## 8.9 Database

The Database section has three tabs for setting connections (a Graphic Hub, Failover servers and Deploy servers).

- [Global Properties](#)
- [Failover Properties](#)
  - [To Add Redundant Servers to the Failover List](#)
- [Deploy](#)
  - [To Add Deploy Servers](#)

### 8.9.1 Global Properties

Use this section to configure the Graphic Hub database connection settings.

The screenshot displays the 'Global' tab of the database configuration interface. It features several input fields and dropdown menus for connection parameters. The 'Port Number' is set to 19396. Under 'Communication Timeout Settings', the values are 15 sec for Failover, 30 sec for Global RT, and 15 sec for Establishing. Checkboxes for 'Show Auto Log On', 'Auto Log On', and 'Popup Server Messages' are checked, while 'Import by Name' is unchecked. The 'Archive Bit-Mode' is set to '64 Bit'. Other options like 'Prefix Mode', 'Prefix Converting Info', and 'Prefix Path' are currently disabled or empty.

- **Host Name:** Displays the name of the Graphic Hub naming service. The naming service is always a one to one map to the Host Name of the machine running a Graphic Hub.

- **Hub:** Displays the Graphic Hub server name.
- **Port Number:** Displays the listener port number for a Graphic Hub. The default port number is `19396` , and should normally not be changed.
- **User:** Sets the default user.
- **Password:** The password for the default user.
- **Additional Host Names:** Displays the host name or IP address of a Graphic Hub database located on a different subnet, to make it selectable in the log onscreen database drop-down list. Multiple entries can be added, and must be separated by a semicolon. Hosts located on different subnets are highlighted in turquoise in the drop-down list.
- **Communication Timeout Settings:**
  - **Failover Timeout (sec):** Sets the maximum time to wait before a fail over is initiated from the main to the replication Graphic Hub.
  - **Global RT Timeout (sec):** Sets the maximum response time for any request to a Graphic Hub.
  - **Establishing Timeout (sec):** Sets the maximum waiting time to establish a connection to a Graphic Hub.
- **Show Auto Log On:**
  - **Yes:** Shows the **Auto Log On** check box in the Graphic Hub log on window.
  - **No:** Hides the **Auto Log On** check box in the Graphic Hub log on window.
- **Auto Log On:** Enables or disables automatic log on to a Graphic Hub. This disables the log on screen for Viz Artist/Engine.
- **Import by Name:** Checks for objects by name rather than by UUID when set to `Yes` . Checks by UUID when set to `No` .
- **Popup Server Messages:** Enables or disables popup server messages. Disabled only works on local host.
- **Archive Bit-Mode:** Sets the bit-mode in which the archive is saved.

 **Note:** For compatibility, 32-bit should be enabled if scenes are imported to Viz Artist versions prior to build 2310.

- **Prefix:** Needed if an external control application is used that sends commands containing certain path locations, but where the path of the files is a different one on the Graphic Hub (because they were deployed to a specific location).
  - **Prefix Mode:** Activates the prefix mode.
  - **Prefix Converting Info:** Shows the prefixed (final) paths in the console.
  - **Prefix Path:** Contains the prefix path string that is used for incoming commands containing path parameters.

 **IMPORTANT!** Every time the Viz Engine connects to a Graphic Hub, it creates a mapping of all GH REST connections. This mapping is used to speed up images loading by directly downloading images from the Graphic Hub instead of using the GH REST. If the connected GH REST is reconfigured to a different Graphic Hub, then the mapping is not updated until the Viz Engine disconnects and reconnects to Graphic Hub.



## 8.9.2 Failover Properties

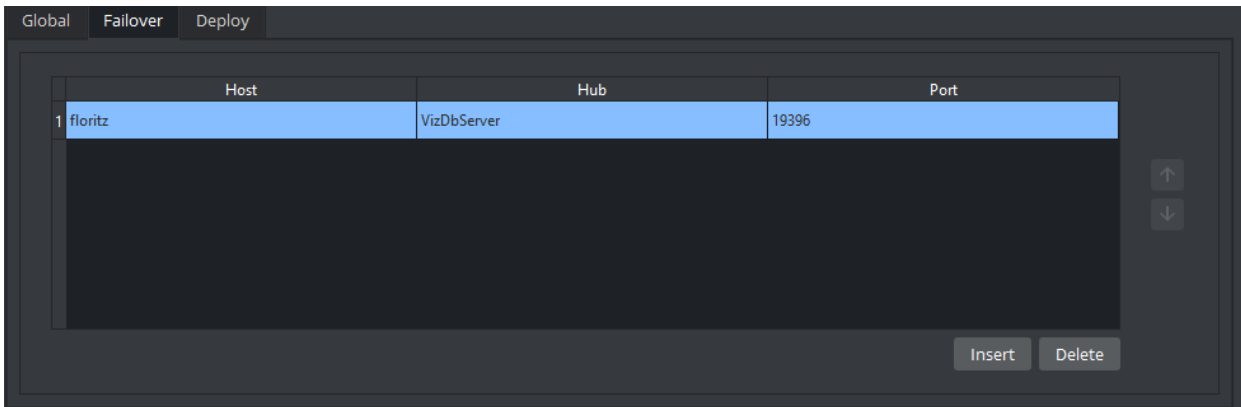

### To Add Redundant Servers to the Failover List

1. Click **Insert**.
2. Enter the **Host Name** of a Failover server.
3. Enter the Graphic **Hub** instance for Failover.
4. Enter the **Port** number of the Graphic Hub for Failover.
5. Use the **Up** and **Down** buttons in the database Failover list to raise and/or lower a database's priority in the event of Failover.
6. Click **Save**.

## 8.9.3 Deploy

### To Add Deploy Servers

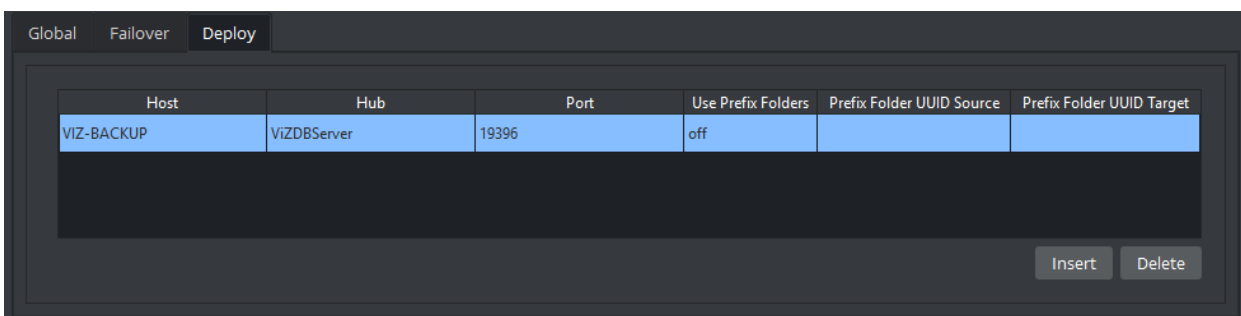

**Note:** To configure deploy servers, the user you are currently logged in with on the source server must exist on the destination server with the same credentials.

1. Click **Insert**.
2. Enter the **Host Name** of a deploy server.
3. Enter the name of the deploy Graphic Hub.
4. Enter the **Port** number of the deploy Graphic Hub. The default port is `19396`.

5. If specific source and destination folders are required, set **Use Prefix Folders** to **Yes** .

Use Prefix Folders: Provides a simple server copy functionality that is able to rebuild the underlying structure from a source folder on the source server to a destination folder on the destination server. All references outside the source folder are rebuilt according to the original structure, under `/data/`. Set to **Yes** to select a source and destination folder for the deployment. Set to **No** to keep the structure the same as on the source server. See [To Add Deploy Servers](#) below for an example setup.

- **Prefix Folder UUID Source:** Displays the source folder UUID on the Graphic Hub to deploy from.
- **Prefix Folder UUID Target:** Displays the target folder UUID on the Graphic Hub to deploy to **Use Prefix Folders**. Provides a simple server copy functionality that is able to rebuild the underlying structure from a source folder on the source server to a destination folder on the destination server. All references outside the source folder are rebuilt according to the original structure, under `/data/`. Set to **Yes** to select a source and destination folder for the deployment. Set to **No** to keep the structure the same as on the source server. See [To Add Deploy Servers](#).

- a. Enter the UUID of the **Prefix Folder UUID Source**.
- b. Enter the UUID of the **Prefix Folder UUID Target**.

6. Click Save.

#### See Also

- [Graphic Hub User Guide](#)

## 8.10 Font Text Options

In this section, there are two tabs.

- Classic
- Viz Engine

### 8.10.1 Classic

In this tab, the font and text options for the Classic Render Pipeline can be configured.

The screenshot shows the 'Classic' tab selected in the 'Font Files' section. The configuration options are as follows:

- Default Font Encoding:** Default, JIS, SJIS, EUC, Unicode, **UTF-8**
- Default Text Orientation:** **Left**, Center, Right
- Default Text V.-Orientation:** Top, **First Line**, Center, Bottom
- Default Text Direction:** **Left to Right**, Right to Left, Top to Bottom, Bottom to Top
- Font Handling:** **Font file**, Complex script
- Advanced import for Asian languages:**
- Blur Import:** Blur 1, Blur 2, Blur 3, Blur 4
- Outline Import:** Outline 1, Outline 2, Outline 3
- Calculate Max Bounding Box Size:**
- Replace missing Characters with:** 0 ASCII Value
- Preserve newlines/spaces:**

- **Font encoding.** Available options are:
  - **Default:** Sets the font encoding to single character interpretation (limited to 255).
  - **Japanese Industry Standard Code (JIS):** Sets Japanese industry standard code character encoding.
  - **Shifted Japanese Industry Standard Code (SJIS):** Sets the newer Shift JIS character encoding standard which sets aside certain character codes to signal the start of a two-character sequence.
  - **Extended Unix Code (EUC):** Sets Extended Unix Code (EUC) character encoding that is a multi byte character encoding system used primarily for Japanese, Korean, and simplified Chinese.
  - **Unicode:** Sets the Unicode character encoding where every two characters are inter-operated as one (not widely used).
  - **UTF-8:** Sets UTF-8 (8-bit UCS/Unicode Transformation Format) character encoding that is a variable-length character encoding for Unicode (default).
- **Default Text Orientation:** Sets the default horizontal text orientation.
- **Default Text V. Orientation:** Sets the default vertical text orientation.

- **Default Text Direction:** Sets the default text direction.
- **Font Handling:** Defines how fonts are handled.
  - **Font file:** Sets the font kerning to Font file that is mainly used for languages written from left to right.
  - **Complex script:** Sets the font kerning to Complex script. Complex script is mainly used for languages written from right to left, or when one character is composed of one or several glyphs.

✘ **IMPORTANT!** With font handling in Complex Script mode, all fonts used must be installed in Windows to avoid unpredictable text behavior.

- **Advanced Import for Asian Languages:** Imports fonts to be used with special features (including vertical text and EUDC) when enabled. This feature is useful for some Asian languages. The fonts must be installed in the operating system.
- **Font Import:** Sets the Font import. Available options are; File (Standard) and Windows (Advanced).
  - **File (Standard):** Imports and stores fonts on the database.
  - **Windows (Advanced):** Stores only the font name on the database. For this to work the font must be installed on the Windows system where Viz Engine resides.
- **Blur Import:** Enables blur levels for imported fonts. These options are used for Classic fonts only.
- **Outline Import:** Enables outline levels for imported fonts. These options are used for Classic fonts only.
- **Calculate Max Bounding Box Size:** Enables Viz Artist/Engine 3.x to calculate the bounding boxes as they were calculated in older versions. In Viz Artist/Engine 3.x a text object's bounding box height increases if a capital character is entered (for example, an umlaut (double dots)). In Viz Artist/Engine 2.x, the bounding box height was always the same and independent of the characters in the text object. Available options are Active and Inactive. Default is Inactive (false).
- **Replace missing Characters with:** Replaces a missing font character in a font file with a default font character. The Unicode value refers to the decimal value of the replacement character in the Unicode table (valid values are 0-65535). Normal usage would select a (42) or (95).
- **Preserve newlines/spaces:** Does not remove spaces and newlines at the end of the text when saving and reloading a scene when set to **Active**. This influences bounding boxes. The default state is *Inactive*.

## 8.10.2 Viz Engine

In this tab, Font and Text options for Viz Engine Render Pipeline can be configured.

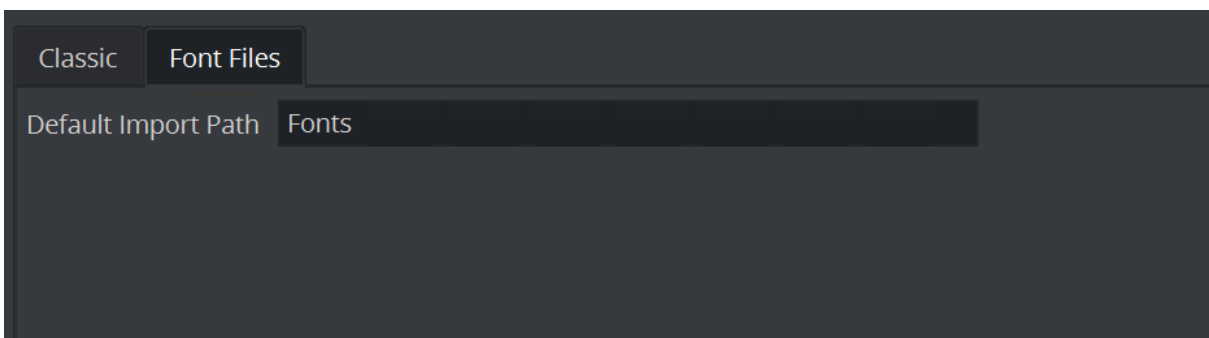

- **Default Import Path:** A default location in Graphic Hub to which the font importer imports new FONT\_FILE(FL) or FONT\_FACE(FF).

## 8.11 Global Input

The Global Input settings influence the generation and handling of Six Degrees of Freedom (6DoF) messages that can be distributed to several Viz Engines.

6DoF is used when working in 3D space in combination with special input devices such as a mouse. A mouse uses two coordinates (xy) which Viz Artist/Engine is able to translate into three coordinates (xyz) based on a grid.

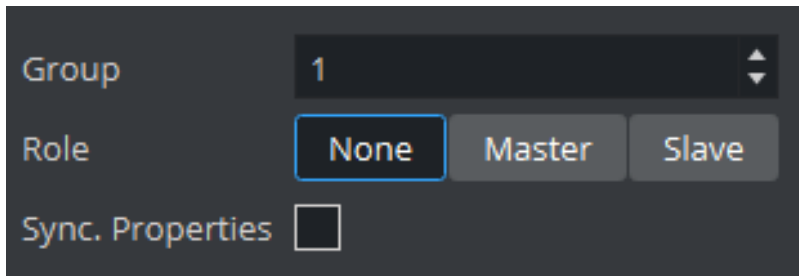

- **Group:** Defines which multicast group the generated or received messages belong to. If more than one group is to be defined, a unique Group number must be set for each group
- **Role:** Defines how messages are generated and processed. Alternatives are; None, Master and Slave.
  - **None:** Generates and processes messages on the local Viz Engine only.
  - **Master:** Creates messages for itself and the defined group.
  - **Slave:** Reads and processes 6DOF messages, but is not allowed to create them.
- **Synch. Properties:** Makes the synchronization of Viz Engine Scene properties **Active** or **Inactive**.

### 8.11.1 To Synchronize Multiple Viz Engines

1. Start Viz Config on all involved render machines.
2. Set the same Group ID for all Viz Engines.
3. Set **Synch. Properties** to **Active**.
4. Save and close Viz Configuration on all machines.
5. Open the Control Panel on all render machines.
6. Deactivate all unused network connections.
  - Viz Engine always uses the first network connection setup by the Windows operating system.
  - Synchronized engines work within the same network segment only because it is using multicast, hence, it is important to use the right connection.
  - The first connection can be determined by setting a manual metric in Windows: see <http://support.microsoft.com/kb/299540>.
7. Start all Viz Engines again.
8. Create a simple test scene with a geometry and the Synchronized Properties plug-in (**Built Ins > Container > Global**) on the same container.
9. Save the Scene.
10. Open the Scene on all involved Viz Engines.
11. Move the geometry on one Viz Engine. All the other Viz Engines show the same object movement.

---

## 8.12 Image File Name Convert

In this section, nine different replacement configurations can be set for image file names.

This can be useful if you need to remap certain locations.

replace	with
C:\IMAGE\	D:\VOS\

- **Replace:** Defines the string to be replaced.
- **With:** Defines the replacement string.

**Example:** If an image file name starts with the string `Replace` this part of the file name can be replaced by the string `With`.

## 8.13 Import 3D Options

In this section, parameters which influence the import of 3D objects can be configured. There are three different formats:

- Wavefront
- AutoCAD
- 3D-Studio

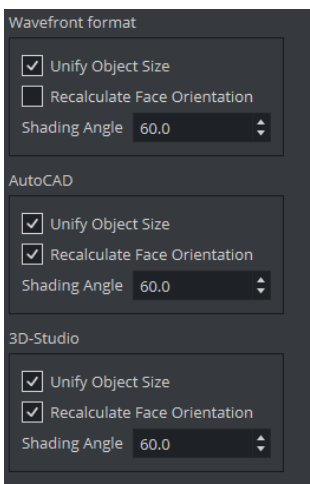

- **Unify Object Size:** Recalculates all vertices during import in a way that the object center is moved to the origin (0,0,0), and the size of the object is 100 cm in its largest extent when enabled. If disabled, all vertices retain their values as defined in the original file. An object could appear invisible in a Viz Artist scene because the object is translated a lot from the origin or is scaled up or down a lot. It may be necessary to deactivate the unification to be able to recombine several separately imported objects that must keep their size and relative position.
- **Face Orientation:** Rearranges the orientation of object faces during import when enabled. Polygonal 3D models often do not have a consistent face orientation, but for performance reasons, Viz Engine expects that all faces of an object point to the same direction.
- **Shading Angle:** Recalculates the normals from the geometry to make lighting possible, if the 3D object has no normal vector information. This recalculation is influenced by the shading angle, which acts as a threshold between sharp and soft edges.

**Note:** A shading angle value of 60 means that an edge between two faces is considered to be a soft edge for angles below 60 and a sharp edge above this level. 60 is the default shading angle.

## 8.14 Local Settings

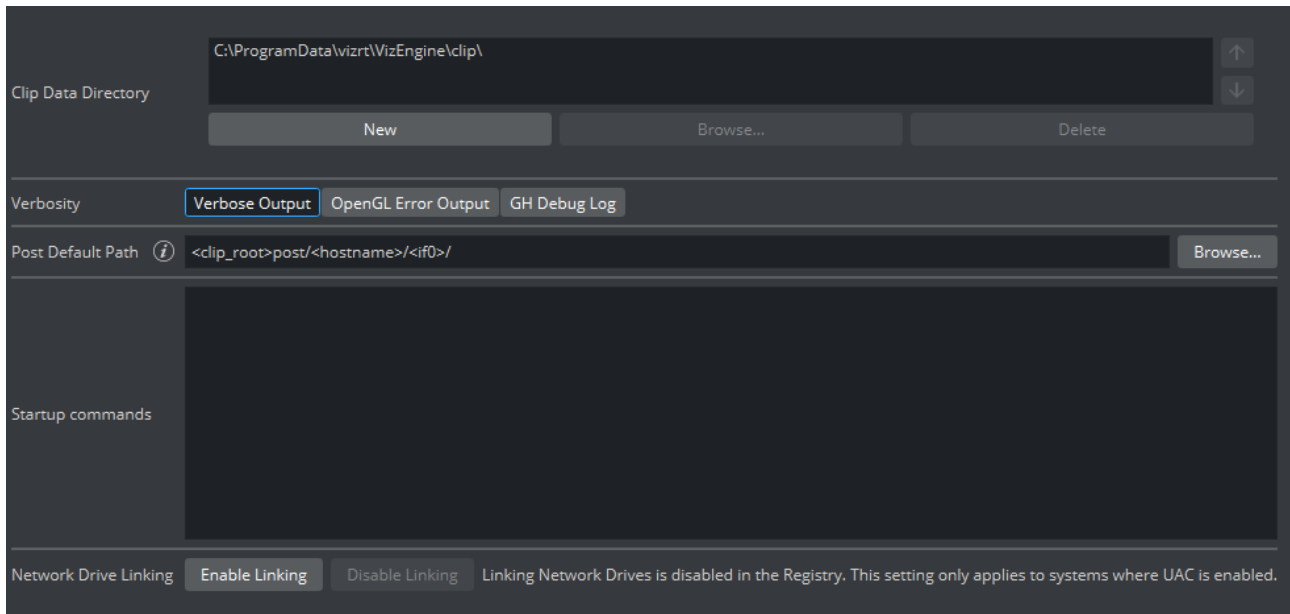

- **Clip Data Directory:** Sets the clip directory (default directory is `D:\` drive). Multiple directories can also be selected (see [Select Multiple Directories](#)).

**Note:** This directory is also used for Viz One installations, as the root parameter for the Fsmon and Mediaftp services (see [Viz One](#)).

- **Verbosity:** Selects content of log files, if no selection is made only the default content of the log file is created:
  - **Verbose Output:** Enables the most information in the Viz Engine Console.
  - **OpenGL Error Output (AMD):** Enables default content of the log file with the addition of OpenGL Error Output (AMD).
  - **GH Debug Log:** Enables default content of the log file including Write GH Connection Log.
- **Post Default Path:** Sets the default location of **Render to Disk** clips.
- **Startup commands:** Saves commands that are executed on startup, but after the initial setup configuration and before the main render loop activates. Examples:

```
FEEDBACK*CLIENT ADD localhost 2001
FEEDBACK*COMMAND ADD localhost 2001 CLIPOUT
RENDERER*MAIN_LAYER SET_OBJECT Vizrt_RD/mra/Reference/TC/TC_DISPLAY
MAIN*DEBUG_CONTROL*RENDERINFO*PERFORMANCE SET 1
```

**Note:** Log files are written to the `<viz data folder>` directory, normally `C:\ProgramData\Vizrt\VizEngine`. This directory is by default hidden in Windows, so to navigate to this directory in Windows Explorer specify the explicit path. For more information see [Viz Log Files](#).



- **Network Drive Linking:** Enables to allow Viz Artist access to mapped network drives on certain systems where UAC is enabled. A machine reboot is required to apply the change.

### 8.14.1 Select Multiple Directories

More than one clip directory can be selected. When more than one directory path is selected in the **Clip Name** box, change the file path to `<clip_root>`. The included directories are parsed when executing the search, returning video clips with file names matching the search criteria.

**Example:** Search for a video clip named `next_tuesday.avi` in `D:\AEClips\AFL\Promos`. In the **Clip Name** box, change `D:\AEClips\AFL\Promos` to `<clip_root>`. The filename displayed in Viz Artist should be `<clip_root>\next_tuesday.avi`.

**Note:** The directory has to match the directory set when the Mediaftp service for video transfer from Viz One was installed.

Multiple directories can be used with:

- Dual Channel and Trio Box CG configurations, or
- With any Viz Artist/Engine configuration for the selection of a secondary video clip directory if a directory fails.

If the file path for a video clip is set to `<clip_root>` and the first directory fails, the same video file is searched for in the next directory in the Clip directory list. If the **Clip Name** box is used to search for a video when multiple Clip directories are selected, the search defaults to the last used directory.

### 8.14.2 SAM SDC01, SDC02, and SDC03 Protocols

To enable or disable a supported SAM protocol please change the `SAMSDC0x_enable`. By default those protocols are switched off. The listening is changed with `SAMSDC0x_address`. If one needs to configure multiple instances those listening addresses need to be unique among the Viz Engine instances.

#### SAM SDC01

```
## enable the SAM SDC01 protocol. This is disabled by default.
## SAMSDC01_enable: Default=0
SAMSDC01_enable = 1
## the SAM SDC01 protocol listening endpoint.
## SAMSDC01_address: Default=0.0.0.0:2055
# SAMSDC01_address = 0.0.0.0:2055
```

and

## SAM SDC02

```
## enable the SAM SDC02 protocol. This is disabled by default.  
#* SAMSDC02_enable: Default=0  
SAMSDC02_enable = 1  
## the SAM SDC02 protocol listening endpoint.  
#* SAMSDC02_address: Default=0.0.0.0:2056  
# SAMSDC02_address = 0.0.0.0:2056
```

and

## SAM SDC03

```
## enable the SAM SDC03 protocol. This is disabled by default.  
#* SAMSDC03_enable: Default=0  
SAMSDC03_enable = 1  
## the SAM SDC03 protocol listening endpoint.  
#* SAMSDC03_address: Default=0.0.0.0:2057  
# SAMSDC03_address = 0.0.0.0:2057
```

### See Also

- **Clip Properties** in the [Viz Artist User Guide](#)

## 8.15 Maps

The screenshot shows the 'Maps' configuration window with the following settings:

- Map Server:**  Map server dll not found. Please check if the Viz World Client is installed properly!
- Server:** cra-maps
- Project:** (empty dropdown)
- Map Size:** Width 512, Height 512
- Cache Directory:** C:\tmp (with Browse... button)
- Memory (Images):** Cache Size 32 MB, keep on Disk 15 Days
- 2nd Cache Directory:** (empty dropdown)
- Viz World:** C:\ProgramData\vizrt\VizEngine\ (with Browse... button)
- Vers. 12 or higher:** Priority 0,  Network Monitor
- Attribution Font:** Verdana
- Copyright Info:**  Bold,  Italic,  On Top,  On Right
- Language:** 0

- **Map Server:** Enables or disables Viz World Server (WoS) connection for Viz World Client (WoC). If there is a problem with the Viz World installation, an error message is displayed next to the **Active/Inactive** button.
- **Server:** Sets the Viz World Server host.
- **Project:** Sets the default map project that opens with the client application.
- **Available:** Lists all available Viz World Server projects.
- **Map size:** Sets the default map size that is used with the client application.
- **Cache Directory:** Sets the cache directory for cached maps which can be a local drive, mapped drive or a Universal Naming Convention (UNC) path.

**✘ IMPORTANT!** Make sure the Cache Directory folder is configured with read and write access rights.

- **Memory (Images):** Sets the number of images to keep in memory.
- **On disk (Days):** Sets the number of days to save images on disk.

- **2nd Cache Directory:** Enables a second cache (see Cache above). The main purpose of the second cache is to enable redundancy in those cases where a main cache directory is on a different computer and for some reason fails. Another use case is to use it as a local cache to save loading time in more complex operations. To shorten load time, copy large static files to the correct local cache folder. In the *3D Map Setting* plug-in, there is a **Sync Local Cache Folder** button which copies all required files to the local cache. Note that the second cache directory settings can only be used by Viz World version 12.0 and later.
- **Priority:** Sets the machine's connection priority to the Viz World Server (Wos). Setting a number, where **1** is the lowest and **100** is the highest you may override connection priorities set by other machines. The configuration interface allows you to prioritize client connections from Viz Artist and On Air Viz Engine's used for preview and program output. Viz Engines must be in On Air mode for them to be prioritized. For Viz World Map Editor you can set it from its context menu. To enable this behavior on the server side you need to enable WoS to prioritize its connections/log ins. For more information, see the [Viz World User Guide, Server Launcher Configuration](#) section. If the configuration option is not visible, [add the VizWorld.ini](#) file and set the priority.
- **Network Monitor:** Enables you to monitor relevant network connections (server and cache folders). If you do not monitor the network and you try to connect over a disconnected network, connecting to a server or a UNC path, it takes time before the system reports back (for example, 30 seconds or more). Enabling network monitoring avoids such connection issues. Note that the network monitor only monitors a cache folder that uses a UNC path (not mounted/mapped drives). If the configuration option is not visible you need [add the VizWorld.ini](#) file.
- **Attribution Font:** Sets the font for the attribution.
- **Bold:** Sets the attribution font to **bold**.
- **Italic:** Sets the attribution font to *italic*.
- **On Top:** Places the attribution image to the top in the screen. Default is **bottom**.
- **On Right:** Places the attribution image to the right in the screen. Default is **left**.
- **Language:** The default language of Map Server.

### 8.15.1 To Add the VizWorld.ini File

1. Create and save a *VizWorld.ini* file to the following location: `<viz install folder>\plugin\data\maps`.
2. Open the file and enter the following:

```
Monitor=1 Priority=1 Language=[my Language ID]
```

3. **Save** the file and start, for example Viz Config, to see the configurable parameters.
  - a. **Monitor** enables network monitoring. For more information see the **Network Monitor** setting under the [Maps](#) section.
  - b. **Priority** sets Viz connection priority to the Viz World Server. For more information, see the Viz World User Guide.
  - c. **my Language ID** refers to the order of languages in your list of languages (for example, English = **0**, Arabic = **1**, Hebrew = **2** and so on).

For more information see the **Language** setting under [Maps](#).

## 8.16 Matrox

In the Matrox section, assign Matrox Input and Output channels to Viz Engine Input and Output channels. The GUI shows a drop down menu for the configurable parameters. The parameters available are dependent on the installed hardware.

This page provides information about the following:

- [General Properties](#)
- [VideoOut Properties](#)
  - [Map to Config Channel](#)
  - [Fill Properties](#)
  - [Key Properties](#)
  - [Multiconnector Mode](#)
  - [Manager, Repeat and 3G Properties](#)
  - [VBI Properties](#)
  - [Configuration File Only](#)
- [M264 Encoder/Decoder Boards](#)

### 8.16.1 General Properties

The General Properties Panel shows information about the installed hardware.

The screenshot displays the 'General Properties' panel for a Matrox device. It features several sections with configuration options:

- Serial Number:** A543198
- Board Info:**
  - Board: XMIO3/6/100, UPG/100/U55, UPGIO/6/UX2
  - Class: 48
  - Video Out: B(2/6;4/8;9/11;10/12)
  - Codecs: ProRes
- DSX Info:** built with: 10.4.101.1334 installed version: 10.4.101.1334
- Enable Hardware DVE:** Active
- Shared Input Host:** Inactive
- CC Extraction:** Inactive
- Print Clip Info:** 0
- Watchdog:**
  - Use Watchdog: Inactive
  - Timeout: 999

- **Serial No.:** Shows the serial number of the installed Matrox board.
- **Board Info:** Shows the model and type of the Matrox board.
- **DSX Info:** Shows the software version and driver version.
- **Enable Hardware DVE (former Fast Texture Mode):** Disable to shorten the 'in out' delay in Texture Mode to a minimum.

 **Note:** If **Enable Hardware DVE** is set to `Inactive`, **DVE** does not work (see **Video Clip Playout Considerations** and **Video Playout** in the [Viz Artist User Guide](#)).

- **Shared Input Host:** Used to share the input with other Viz Engine instances.
- **CC Extraction:** Enables or disables the closed captioning extraction for [Matrox X.mio3 - DSX LE 4](#).
- **Print Clip Info:** Enables printing of clip information to the console when activated. However, such information may cause the render loop to stall. Default mode is `Inactive`.
- **Watchdog:** Sets a timer that allows a system to continue video pass-through during an application crash or system failure (see also [Watchdog \(Matrox X.mio Series\)](#) and [Video Board](#)):
  - **Use Watchdog:** When set to **Active** enables the Matrox X.mio watchdog feature. It passes the input signal to a hardcoded output port as soon as Viz Engine is unresponsive. Default mode is `Inactive`.
  - **Timeout:** Sets the time, in milliseconds, until the watchdog takes over control. This value should not be smaller than the time of two fields/frames. Default value is `999 ms`.

 **Note:** **Use Watchdog** and **Timeout** can also be set and changed in [Video Board](#).

- **Genlock**
  - **Use Flywheel:** Adopts a tracking mode if the genlock signal is interrupted or lost that maintains the signal frequency until the source genlock signal is regained when activated. Default mode is `Active`.
  - **Max Recovery Time:** Represents the time in milliseconds (ms) provided to the flywheel to attempt to regain the genlock before an abrupt jump to the locked state is performed. Default value is `15`.
  - **Max Unlock Time:** Represents the time in milliseconds (ms) provided to the flywheel to remain in the unlocked state before switching to the free running state. Default value is `15`.

## 8.16.2 VideoOut Properties

In the VideoOut panel, you select which Viz Artist/Engine Output is mapped to the selected Matrox output. The VideoOut panel shows the mapped Viz output channel and its editable parameters. When your video input is set to *UHD* in the Video Input section of the config menu (see [Video Input: Live Input](#)), Matrox channels B, C and D are disabled.

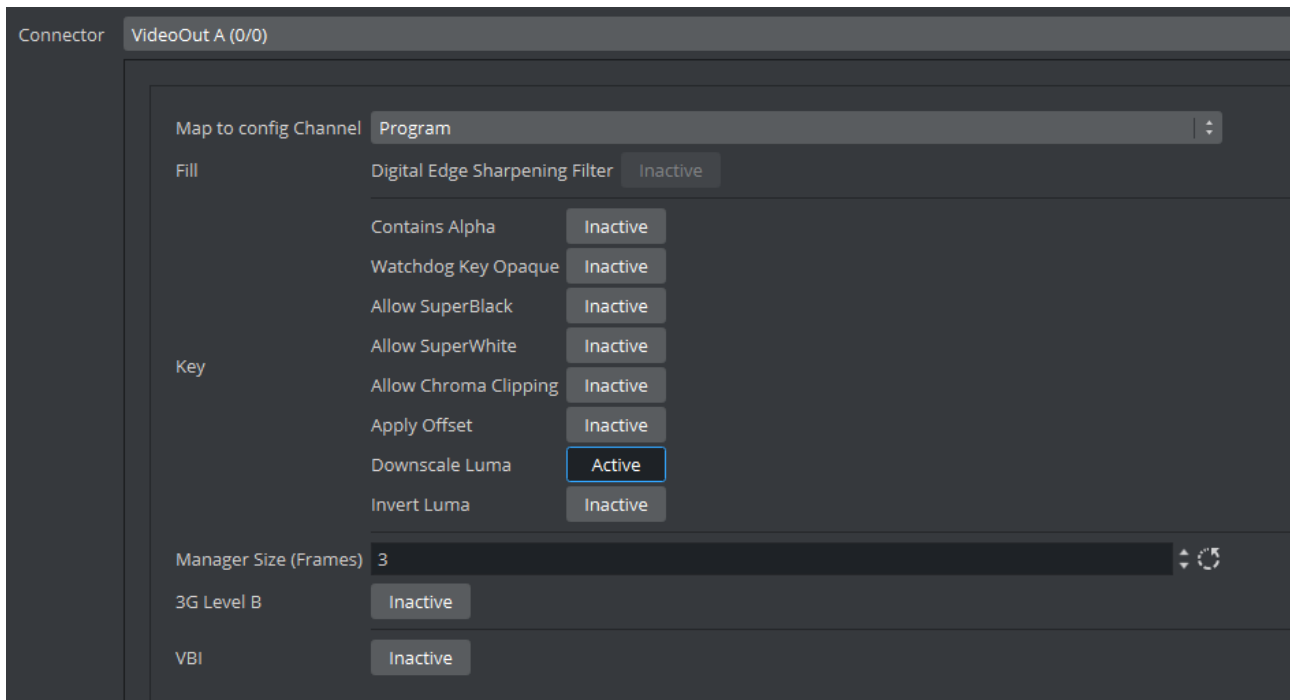

**✘ Important:** If the configuration is done for a Dual Channel UHD setup using SMPTE ST 2110, the second Engine needs to use the second SFP pair for output. See [Explicit Usage of the Second SFP Pair on Matrox X.mio5 Q25](#) for more information.

## Map to Config Channel

- **Map to config Channel:** Selects which video out channel is mapped to the selected Matrox video out channel. Select an Output channel from the drop-down menu. Only channels not already in use are shown. On single channel configurations, **VideoOut A** is usually mapped to **Program**, and **VideoOut B** to **Preview**. On *dual* Channel configurations, the first channel maps **VideoOut A** to **Program**, and the second maps **VideoOut B** to **Program**.
  - **Unused:** Does not map this Matrox channel for output.
  - **Program:** Maps the Program output to the selected video output of the Matrox card.
  - **Preview:** Maps the Preview output to the selected video output of the Matrox card.
  - **Clean:** Outputs video without overlay graphics. Clean mode enables and activates a second output feed. This feed consists of DVE video content without any graphics and video textures: only live video, clip video, IP input, streaming input. This stream also includes a separate audio mix corresponding to the video only, excluding stage audio such as audio clips, plug-in audio or text-to-speech, from the clean feed audio mix. If Watchdog functionality is required, **VideoOut A** must be mapped to **Clean**, and **VideoOut B** to **Program**. The Clean mode requires Matrox X.mio3, X.mio3 IP, X.mio5, or X.mio5 IP (Watchdog functionality is not supported on X.mio5 and X.mio5 IP).
  - **Matte Scene:** Used for virtual studios, the effective matte scene.
  - **KeyerAuxChannel:** Shows the key preview to adjust the Chroma Keyer.

- **Downscaled Preview:** Outputs a downscaled to HD version of the **Program** output. This channel is only initialized if the **Program** output is configured to UHD. It has the same video content of **Program**, but is downscaled to HD. Otherwise, this channel is ignored by Viz Engine.

 **Note:** A clean feed increases the video In → Out delay by one frame!

## Fill Properties

- **Digital Edge Sharpening Filter:** Applies an edge sharpening filter to digital output video. Default mode is `Inactive`. SD configurations only.

## Key Properties

- **Contains Alpha:** Defines if this output channel provides key information on the associated key output connector.
- **Watchdog Key Opaque:** Specifies if the output key must be opaque or transparent when the watchdog unit activates. Default mode is *Inactive*.
- **Allow Super Black:** Allows the luminance of the output signal to fall below the nominal SMPTE pixel values (7.5 IRE units) when enabled. Default mode is *Inactive*.
- **Allow Super White:** Allows the luminance of the output signal to exceed the nominal SMPTE pixel values (100 IRE units) when enabled. Default mode is *Inactive*.
- **Allow Chroma Clipping:** Determines whether to clip over-saturated chroma levels in the active portion of the output video signal. Default mode is *Inactive*.
- **Apply Offset:** Applies an offset to the luminance values such that the inverted result still falls within the 16-235 range. Default mode is *Inactive*.
- **Downscale Luma:** Compresses the luminance range of the output key signal from 0-255 to 16-235. Default mode is *Active*.
- **Invert Luma:** Inverts the luminance part of the output key signal (inverts the key). Default mode is *Inactive*.

## Multiconnector Mode

Defines which multiconnector mode to use for 3G / 12G SDI channels. This setting is only available for Series 5 Matrox SDI cards (for example, X.mio5 12G SDI) when configured to UHD.

- **None:** 12G single connector mode.
- **2SI:** Quad-Link 2 sample interleave.
- **Square Division:** Quad-Link Square division.

 **Important:** Multiconnector mode is only enabled for UHD resolutions and when at least four connectors are available. If fewer than four connectors would be free for SQD or 2SI, this option is greyed out and the connectors automatically run at their maximum bandwidth.



## Manager, Repeat and 3G Properties

- **Manager Size (frames):** Sets the number of frames available in the on-board memory for output. A too high value may cause memory problems on the Matrox board. Default value is `3`.
- **3G Level B:** Activates `Level B` for 3G mode in 1080p 50/60/60M (default mode is `Level A`).

## VBI Properties

Use this switch to enable or disable VBI (Vertical Blanking Interval) in the output.

## Configuration File Only

It is possible to increase the delay of the output to `1` frame to mitigate performance related frame drops that are indicated by *Buffer has been dropped, cancelled late* log messages. Increasing the delay to `2` or more frames does not have additional performance benefits.

This setting is only relevant with boards that do not have a hardware mixer (DSX LE series), or if using that mixer was disabled in the configuration. The most common way to disable the mixer is to **Enable Hardware DVE** mode.

Set `Matrox0.VideoOut1.NodeFrameDelay = 0` to values other than `0`.



**Note:** This value is set to at least `1` internally for UHD outputs on X.mio3 and DSX LE4 cards.

### 8.16.3 M264 Encoder/Decoder Boards

M264 encoder/decoder boards are usually configured automatically. If they do not appear in the configuration section, please double check the `Matrox.Devices` entry in the **MATROX\_CONFIG** of the `viz.cfg` file.

It should look like `Matrox.Devices = <device1>,<device2>`.

Depending on your model (for example, a M264 S3, which supports three streams), the entry would look like: `Matrox.Devices = <device1>,<m264device>,<m264device>,<m264device>`.

## 8.17 Memory Management

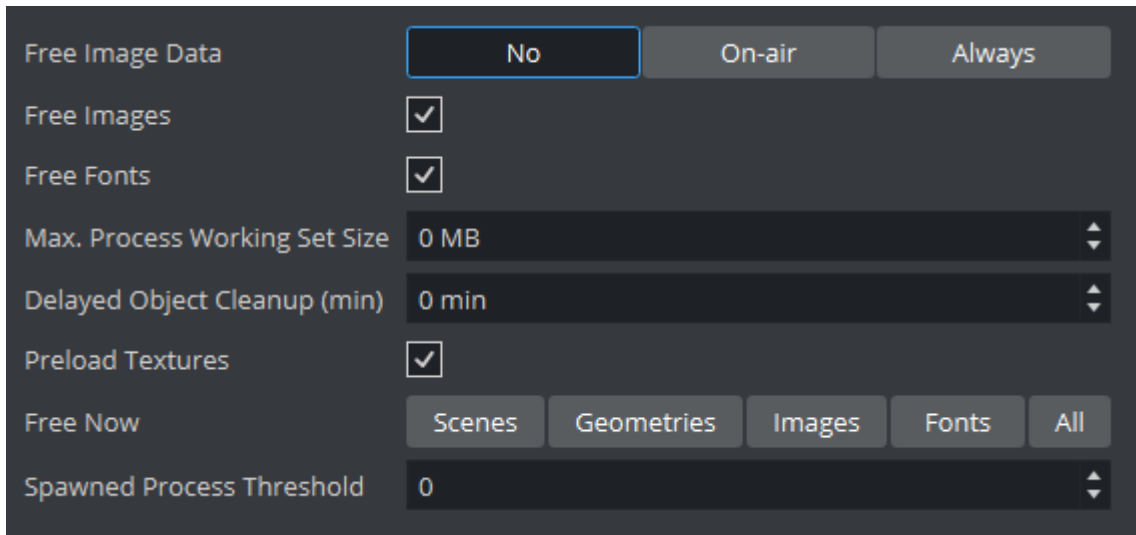

Application memory management involves supplying the memory (main memory and graphic card memory) needed for a program's objects and data structures used for in-memory objects such as images, fonts and so on from the limited resources available. Memory management also recycles memory for reuse when required and appropriate.

In the Memory Management section of the configuration, you can give detailed hints to the Viz Engine how memory should be handled:

- **Free Image Data:** Frees image data after texture creation when enabled ( `On Air` or `Always` ).
  - **No:** Disables the Free Image Data option. This option is faster, but requires a lot of memory.
  - **On Air:** Frees image data when in On Air mode, but not in Viz Artist mode.
  - **Always:** Frees image data every time after the texture was created. This option saves a lot of memory but is slower in case of texture rebuilds.

**Note:** If an image is modified, then its texture is rebuilt faster if the data already lies in the main memory (instead of re-loading it from the database).

- **Free Images:** Removes unused images (not referenced in a loaded scene) from the Image Pool (main memory and graphics card memory) when enabled (`On`).
- **Free Fonts:** Removes unused fonts from the Font Pool when enabled (`On`).
- **Max. Process Working Set Size (MB):** Attempts to automatically unload unused Pool objects once the threshold has been reached. For example, setting it to `6*1024` starts to cleanup as soon as Viz Engine uses more than 6 GB of memory. `0` means, no cleanup happens.
- **Delayed Object Cleanup (min):** Sets the delay to clean up pool objects. Default: `0` minutes which effectively disables the delayed clean up. If set to a value greater than `0`, objects do not immediately get deleted when unloaded from the renderer, and keeps objects in memory for subsequent use. While this improves performance for certain scenarios, it increases the memory footprint of Viz Engine.

- **Preload Textures:** Loads all images which are to be loaded with a Scene (they do not need to be rendered) as textures on the graphics card when enabled (  ). This eliminates the texture creation time during rendering afterwards (for example, useful when initializing a show or a playlist). Default is enabled (  ).
- **Free Now:** Frees the selected unused Pool objects (Scenes, Geometries, Images, Fonts or All) from the memory.
- **Spawned Process Threshold:** Sets the maximum number of child processes spawned by Viz. If the number of child processes exceed the set value, a pool cleanup is automatically triggered. When set to  , automatic cleanups are disabled. The default value is  .

## 8.18 Output Format

You set the output format of the rendering engine on this panel. *All* video hardware configurations are associated with the video standard set here as output format. This setting also defines the frequency (frame rate) at which Viz Engine runs.

	Name	Specification	Dimension	Frequency	Aspect
<input type="radio"/>	NTSC	480I_5994_SMPTE259_NTSC	720 x 486	59.94	4:3
<input type="radio"/>	NTSC	480I_5994_SMPTE259_NTSC	720 x 486	59.94	16:9
<input type="radio"/>	PAL	576I_5000_SMPTE259_PAL	720 x 576	50.00	4:3
<input type="radio"/>	PAL	576I_5000_SMPTE259_PAL	720 x 576	50.00	16:9
<input type="radio"/>	720p HD Progressive	720P_5000_SMPTE296	1280 x 720	50.00	16:9
<input type="radio"/>	720p HD Progressive	720P_5994_SMPTE296	1280 x 720	59.94	16:9
<input type="radio"/>	720p HD Progressive	720P_6000_SMPTE296	1280 x 720	60.00	16:9
<input type="radio"/>	1080i HD Interlaced	1080I_5000_SMPTE274	1920 x 1080	50.00	16:9
<input type="radio"/>	1080i HD Interlaced	1080I_5994_SMPTE274	1920 x 1080	59.94	16:9
<input type="radio"/>	1080i HD Interlaced	1080I_6000_SMPTE274	1920 x 1080	60.00	16:9
<input type="radio"/>	1080p HD	1080P_5000_SMPTE424M	1920 x 1080	50.00	16:9
<input type="radio"/>	1080p HD	1080P_5994_SMPTE424M	1920 x 1080	59.94	16:9
<input type="radio"/>	1080p HD	1080P_6000_SMPTE424M	1920 x 1080	60.00	16:9
<input type="radio"/>	2160p UHDTV1	2160P_5000_SMPTE2036_UHD...	3840 x 2160	50.00	16:9
<input type="radio"/>	2160p UHDTV1	2160P_5994_SMPTE2036_UHD...	3840 x 2160	59.94	16:9
<input type="radio"/>	2160p UHDTV1	2160P_6000_SMPTE2036_UHD...	3840 x 2160	60.00	16:9
<input type="radio"/>	2160p 4K	2160P_5000_SMPTE2036_4K	4096 x 2160	50.00	256:135
<input type="radio"/>	2160p 4K	2160P_5994_SMPTE2036_4K	4096 x 2160	59.94	256:135
<input type="radio"/>	2160p 4K	2160P_6000_SMPTE2036_4K	4096 x 2160	60.00	256:135
<input type="radio"/>	Fullscreen	FULLSCREEN	3840 x 2160	50.00	1.7778
<input checked="" type="radio"/>	User Defined	USER_DEFINED	1920 x 1080	50.00	1.7778

Width:  Frequency:  Offset X:

Height:  Aspect:  Offset Y:

**Adaptive Scene Design**

Preferred Output Format

For PAL and NTSC, you can set aspect ratio to 4:3 (standard TV) and 16:9 (wide screen TV). **Fullscreen** sets the output format to the screen size of the current machine. Fullscreen also allows modification of frame rate setting, but not other settings. Viz Engine supports UHDTV and 4K (see UHDTV and 4K Support ). UHDTV and 4K formats are only displayed when the system hardware supports it.

Click **User Defined** to open a panel below the output format list. You can employ User Defined output format to fit the requirements of multi-pipe systems, such as a video wall. Configure the multi-pipe settings in the right part of the editor.

✓ User Defined	USER_DEFINED	1920 x 1080	50.00	1.7778
----------------	--------------	-------------	-------	--------

Width: 1920  Frequency: 50.0000  Offset X: 0

Height: 1080  Aspect: 1.7778  Offset Y: 0

- **Width:** Sets the width in pixels.
- **Height:** Sets the height in pixels.
- **Frame:** Sets the refresh rate/frequency per frame in hertz (Hz).
- **Aspect:** Sets the aspect ratio. For example 1.778:1 which is 16:9 or 1.333:1 which is 4:3. The designer can set other aspects ratio for each individual scene, as described in the **Scene Settings** page in the **Scene Management** section of the [Viz Artist User Guide](#).

**Note:** Make sure that the physical refresh rate of the graphics hardware and the video hardware are configured with compatible settings.

- **Offset X:** Sets the horizontal alignment in pixels on the screen. Value is calculated from top left of the screen.
- **Offset Y:** Sets the vertical alignment in pixels on the screen. Value is calculated from top left of the screen.

There are three frequency groups/families; 50, 59,94 and 60 Hz. This defines the output format, and how fast Viz Engine operates. The frequency is the same as frames per second. This also defines the input format that is allowed; hence, an NTSC SD input cannot produce a PAL SD output, but an HD input with the same frequency as the SD output would work.

**Information:** NTSC and PAL are not supported by X.Mio5 boards (2110).

### 8.18.1 UHDTV Support

- UHDTV resolution is currently supported on [Matrox X.mio3 - DSX LE 4](#) (SDI video boards only) and [X.mio5](#) (recommended).

### 8.18.2 Adaptive Scene Design

Defines which adaptive format to use. If, for example, a scene holds a "portrait" format, this one is going to be used instead of the default format.

## 8.19 Path Aliases

In this section, up to five favorite archive and ten import paths can be set. These are accessible through Viz Artist's Archive and Import panes.

Alias-Name	Archive-Export-Path	
		Browse...
		Browse...
		Browse...
		Browse...
		Browse...

Export

Alias-Name	Import-Path		Type
		Browse...	Fonts   ⌵
		Browse...	Images   ⌵
		Browse...	Geometries   ⌵
		Browse...	Scenes   ⌵
		Browse...	Audio   ⌵
		Browse...	Archives   ⌵
		Browse...	Video   ⌵
		Browse...	Substances   ⌵
		Browse...	Fonts   ⌵
		Browse...	Images   ⌵

Import

- **Name:** Sets the path alias name for the archive or import path.
- **Path:** Sets the archive or import path which can be a local drive, mapped drive or a Universal Naming Convention (UNC) path.

**✘ IMPORTANT!** Make sure the archive folder is configured with read and write access rights.

### 8.19.1 To Add a Path

1. Enter a descriptive name in the **Name** field.
2. Enter a path in the **path** field, or click the **Browse** button to navigate and select a path.
3. Assign a type. Options are:
  - Fonts
  - Images

- Geometries
- Scenes
- Audio
- Archives
- Videos
- Substances

In this way, when clicking on an alias before a file is imported, the import window automatically opens the designated folder and switches to the assigned type.

4. Click **Save**.

	Alias-Name	Import-Path		Type
Import	Cone	C:\ProgramData\vizrt\VizArtist\import	Browse...	Geometries ▾
	Arial	C:\Program Files\Vizrt\VizArtist\fonts	Browse...	Fonts ▾
	Hot	C:\Program Files\Vizrt\VizArtist\HotFolder	Browse...	Archives ▾
			Browse...	Scenes ▾
			Browse...	Audio ▾
			Browse...	Archives ▾
			Browse...	Video ▾
			Browse...	Substances ▾
			Browse...	Fonts ▾
			Browse...	Images ▾

## 8.20 Plug-Ins

### 8.20.1 Plugin Directories

Since Viz Engine version 4.1, users can add additional directories for plug-ins. These directories are scanned at startup for available plug-ins and Viz Engine initializes them.

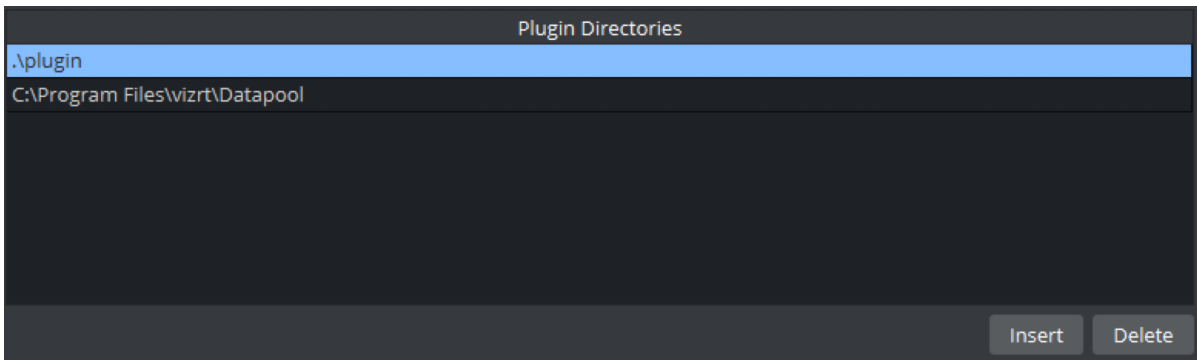

Use the buttons on the bottom to add or remove additional directories.

### 8.20.2 Plug-in Panel List

The Plug-ins panel lists all installed plug-ins recognized as valid. To display all information correctly, you must open Viz Config from Viz Artist, as the plug-ins are not actually loaded in the Viz Config standalone application. However, you can still enable or disable the loading state. Some unlicensed plug-ins do not load, while others do. For unlicensed plug-ins that do load, a watermark is shown. Viz Artist/Engine does not load inactive plug-ins at run-time. If a scene uses a plug-in that is deactivated, Viz Artist/Engine is unable to activate it without restarting.

Plugin Type <span>Scene</span>					
	Folder	Name	Filename	Version	Status Info
✓	Image	BackGroundClip	BackgroundClip.vip	4.0	OK
✓	Data	DataClock	DataClock.vip	2.9	OK
✓	Data	DataInteractive	DataInteractive.vip	2.9	OK
✓	Data	DataMaterialTable	DataMaterialTable.vip	2.9	OK
✓	Data	DataMouseSensor	DataMouseSensor.vip	2.9	OK
✓	Data	DataPool	DataPool.vip	2.9	OK
✓	Texture	Graffiti	Graffiti.vip	4.0	OK
✓	Tools	LODManager	LODManager.vip	4.0	OK
✓	RealFX	RFxCollisionManager	RFxCollisionManager.vip	4.0	OK
✓	Tools	SceneSyncProperties	SceneSyncProperties.vip	4.0	OK
✓	Lineup	TreeStatus	TreeStatus.vip	4.0	OK
✓		VCF	VCF.vip	4.0	OK
✓	MSE	VideoWall	VideoWall.vip	4.0	OK



Plug-in categories are:

- **Extension**
- **Geometry**
- **Container**
- **Scene**
- **Shader**
- **Viz Engine Shader**
- **Fontstyle**
- **RenderToDisk**
- **Inactive**

For detailed information about the various available plug-ins, see the [Viz Plug-ins User Guide](#) in these sections:

- Geometry Plug-ins
- Container Plug-ins
- Scene Plug-ins
- Shader Plug-ins

All plug-ins can individually be activated or deactivated. If a plug-in is inactive it is not loaded at startup. All inactive plug-ins are listed under the **Inactive** panel. Click the drop-down menu to select a plug-in category.

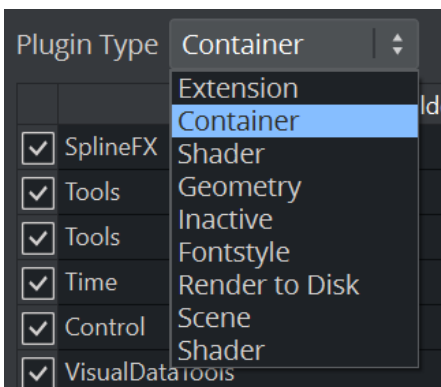

## 8.21 Render Options

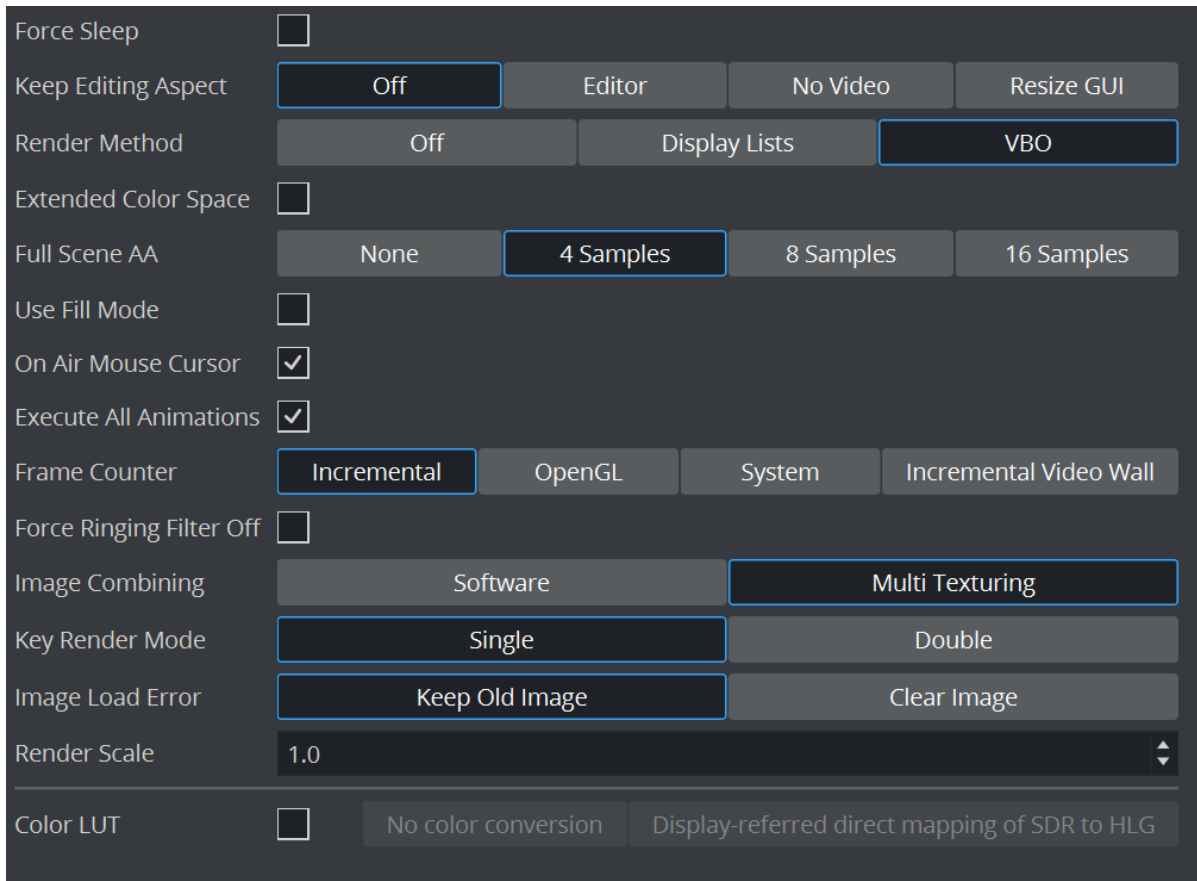

In this section, the following render options can be set:

- **Force Sleep:** Forces the renderer to go to sleep on regular intervals. This allows the GUI to be more responsive. This setting should only be enabled on single processor systems, where the renderer task is using most of the CPU power.

**Note:** This option is only available for non video versions and might cause irregular frame rates.

- **Keep Editing Aspect:** Influences scene designs in Viz Artist mode. Options are:
  - **Off:** Shows scenes only in Anamorphic wide-screen in the 4:3 VGA render window.
  - **Editor:** Shows scenes using a letter-box format during scene editing giving designers the option to set a user defined camera aspect ratio (under **Scene Settings > Rendering**). On Air and Viz Engine modes are not affected.
  - **No Video:** Shows scenes using a letter-box format as long as the video out is inactive. If video out is active scenes are shown in Anamorphic wide-screen in Viz Artist mode.
  - **Resize GUI:** Increases the renderer window to 16:9 format when editing 16:9 scenes. On Air and Viz Engine modes are not affected.
- **Render Method:** Sets the use of `Display Lists`, `VBO` (Vertex Buffer Object), or `Off` :

- **Off:** Requires geometries to be redefined in each render step.
- **Display Lists:** Buffers the geometry definition, which can then be drawn faster. The display list only needs to be updated if the geometry or its parameter changes.
- **VBO:** Vertex Buffer Object is the default Render Method. Filling a **VBO** is faster than creating a display list, which means VBO can give a performance boost if there are several geometry changes or rebuilds in a Scene design. **VBO** is a required setting for object background loading (see **Background Loading** in the Viz Artist User Guide).

 **Info:** Display Lists are legacy and should not be used anymore.

 **Note:** When rendering transparencies, the output from VBOs and Display Lists may differ slightly. Because of this, the render method falls back to Display Lists in objects with transparency properties, for compatibility reasons.

- **Extended Color Space:** Not in use.
- **Full Scene AA:** Sets the Hardware Anti-aliasing (provided by the graphics card). Options are:
  - **None**
  - **4 Samples**
  - **8 Samples**
  - **16 Samples**
- **Fill Mode** <sup>(1)</sup>
  - **Direct:** Does not modify fill output.
  - **Unshaped:** Divides fill by the key when AutoKey is enabled. (In case of a key < 100% this option brightens the fill in the output. The visually correct output can be seen after applying a linear keyer.)
  - **Shaped:** Pre-multiplies fill with the key. (In case of a key < 100% this option darkens the fill in the output. The visually correct output can be seen after applying a linear keyer.)
- **Use Fill Mode (for Post Production and NLE):**
  - **Active:** Uses Fill Mode for Post Production and NLE.
  - **Inactive:** Does not use Fill mode for Post Production and NLE.
- **RGB to YUV** <sup>(1)</sup>: Enables color conversion either in the Shader or on the Matrox board. When alpha on the output is turned off on systems with either the Matrox X.mio3 in **Fast Texture Mode** or the Matrox DSX LE4, **RGB to YUV** must be set to `Shader`. In the case of HDR output, the color conversion has to be set to `Shader` as well. In all other cases, the recommended setting is **Matrox**.
- **On Air Mouse Cursor:** Enables a mouse cursor when in On Air mode and using interactive applications. Should be disabled for Video Wall and when DVI out is enabled.
- **Execute All Animations:** Enables Viz Engine to only animate visible objects when deactivated. Default is `Active`.
- **Frame Counter:** Selects the Frame Counter type for animations. This setting takes effect for Standard-PC versions, that use NVIDIA cards and drivers:
  - **Incremental:** Increases the field counter with every field (smooth animations).
  - **OpenGL:** Tries to requests the retrace counter through OpenGL. If not possible, due to driver or hardware problems, it falls back to the Incremental mode.
  - **System:** Uses the internal CPU clock.

- **Incremental Video Wall:** Advances animation on Viz Engines simultaneously (by incrementing the frame counter based on the elapsed time between render steps) in a Video Wall environment with multiple Viz Engines. If a Viz Engine runs slower than real-time, the next frame (or frames) is skipped to catch up with the Viz Engines running real-time.
- **Force Ringing Filter Off:** Overrides ringing filter (forces it off) when set to **Active**. Forcing ringing filter off can enhance performance at the cost of possibly introducing visual artifacts, typically bands or edges near edges. It is advisable to keep the default value.
- **Image Combining:** Sets a second texture for image combining. In a Texture Editor (see the **Texture Editor** page in the **Scene Management** section of the [Viz Artist User Guide](#)), it is possible to set a second texture which is used for the image combining. The Texture Editor offers two possible modes: The first mode uses the second image as an alpha channel, whereas the second mode defines a blend between the two textures. Configuring Image Combining to Software enables the combination to be calculated entirely on the CPU. Configuring Image Combining to **Multi Texturing** enables the combination to be calculated on the graphics card for combining or blending the two images. In this case, the texture creation is faster and memory is saved as well. Default is Software. If there are performance or memory issues, especially with scenes imported from Viz Artist/Engine 2.x, it is recommended to change this setting to Multi Texturing.

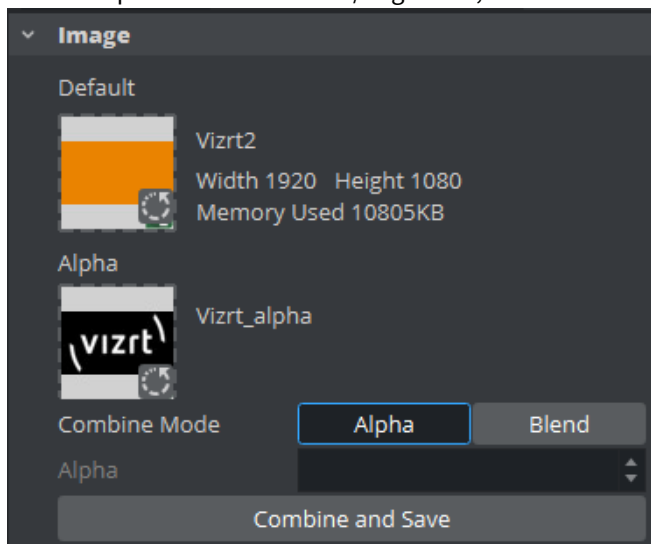

- **Key Render Mode:** Determines how the key should be rendered. This configuration is used when the Key Render Mode (see **Global Settings** in Scene Settings (see the [Viz Artist User Guide](#))) is set to **Config**:
  - **Double Pass:** Uses two rendering steps as in older 3.x versions. Double Pass should be used for old 3.x scenes for not breaking compatibility, for new scenes Single Pass should be used as it is faster.
  - **Single Pass:** Uses one rendering step as in 2.8 versions. A shaped video image has its video data multiplied by its alpha component (1) while the video data of an unshaped image remains untouched (2). Shaped images are also referred to as 'pre-multiplied alpha images'.

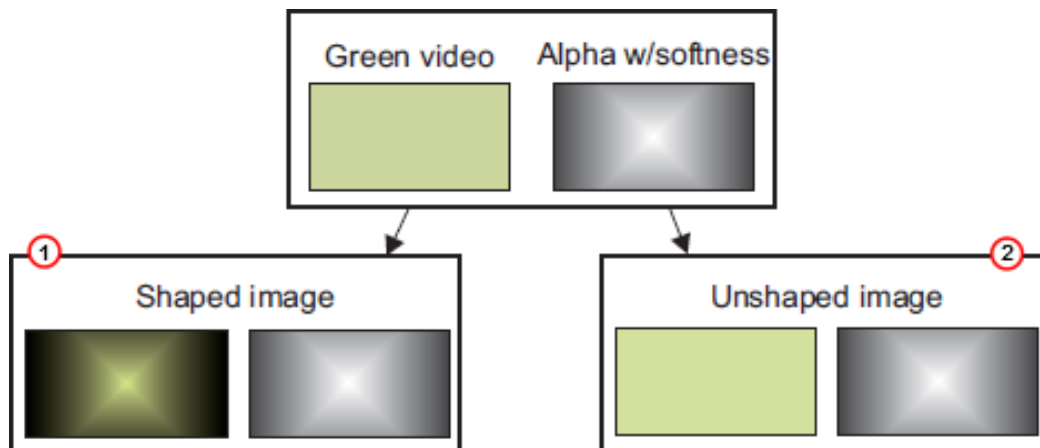

- **Image Load Error:** Configures Viz Engine to keep the old image or clear the image (not showing anything) if an image load error occurs.
- **Render Scale:** Changes the render scale when using a tracking system with lens distortion.
- **Color LUT:** Defines how colors are handled in High Dynamic Range mode.
  - ON OFF enables or Disabled Color mapping.
  - No color conversion: No additional color mapping is performed.
  - Display-referred direct mapping SDR to HLG: Correct mapping of SDR content to match HDR output.

<sup>(1)</sup> : Available on video hardware only.

## 8.22 Scene Default Values

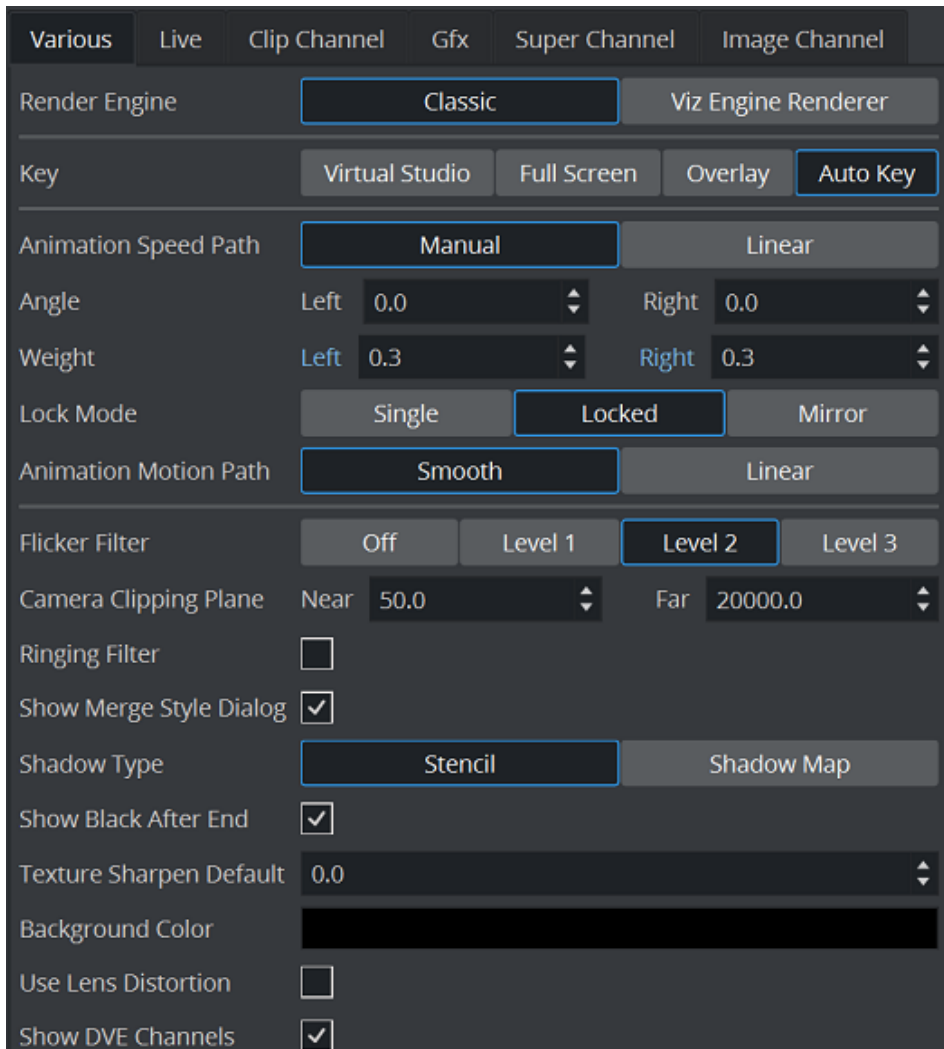

This section configures the default values for new scenes.

- **Render Engine:** Sets the default Render Pipeline. For compatibility with previous versions, select *Classic*. To use the Viz Engine Render Pipeline, select *Viz Engine Renderer*.
- **Key:** Sets the key mode. Alternatives are *Virtual Studio*, *Full Screen*, *Overlay*, and *Auto Key*.
- **Animation Speed Path:** Sets the default animation speed either to **Manual** or **Linear**, and define the default **Angle** and **Weight**.
- **Animation Motion Path:** Defines the default motion path between position key frames. When set to *Smooth*, the motion path is calculated as a Bezier curve between position key frames. Handles are added to the key frame positions in the preview window to allow for path editing. When set to *Linear* the

animated object follows a straight line between position key frames. This setting can be changed individually under **Path**, in the Viz Artist Channel Editor.

- **Flicker Filter:** Reduces interlaced flicker on high contrast objects when enabled. For example small lines and hard objects. Alternatives are `Off`, and `Level 1-3`.
- **Camera Clipping Plane:** Sets the range of the virtual camera. Near sets the close range while far defines the far range. Only objects within this range are rendered.
  - **Near:** Sets the Near value to clip unwanted objects from the foreground. Default value is `50`.
  - **Far:** Sets the Far value to clip unwanted objects from the background. Default value is `20000`.

 **Note:** The camera range is where the Z-buffer is within. So if Z-buffer problems arise, they may be solved by editing the camera clipping plane settings. The camera range setting is also responsible for the quality of your shadow maps.

- **Ringing Filter:** Sets the default value for the Ringing Filter. A ringing filter reduces high frequency values in the video signal created by high contrast and color changes in horizontal directions.
- **Show Merge Style Dialog:** Enables the user, when opening a scene in Viz Artist, to open old-style merged objects and expose containers within it.
  - This feature relates to scenes using old-style ordering of containers within merged objects, and solves the problem with auto-follow. When loading such scenes the dialog lets the user decide how to deal with them.
  - Users that are aware of this and decide to keep the old style can deactivate this dialog.
- **Shadow Type:** Selects how shadows are displayed. Choose between `Stencil` and `Shadow Map`.
- **Show Black After End:** Shows black after a clip has finished playing.
- **Texture Sharpen Default:** Sets the default sharpen value for textures.
- **Background Color:** Set default scene background color.
- **Video Input Layer Targets and Priority:** Sets the defaults for how the specific input channel should be used and its priority. Available options are `Inactive`, `Texture`, `DVE` and `Priority`.
- **Use Lens Distortion:** Activates the Lens Distortion. For detailed settings, see the **Advanced Lens Distortion** page in the **Cameras** section of the [Viz Artist User Guide](#).
- **Show DVE Channels:** Shows the DVE Channels in the Scene Editor if activated.

### 8.22.1 Media Asset Configuration

Here you can pre-configure all available media assets to the different modes of DVE or Texture. This works for Media Assets such as **Live Video**, **GFX Channels**, **Clip Channels**, and **Stream Channels**. **Super Channels** and **Image Channels** can only be pre-configured as `Inactive` or `DVE`.

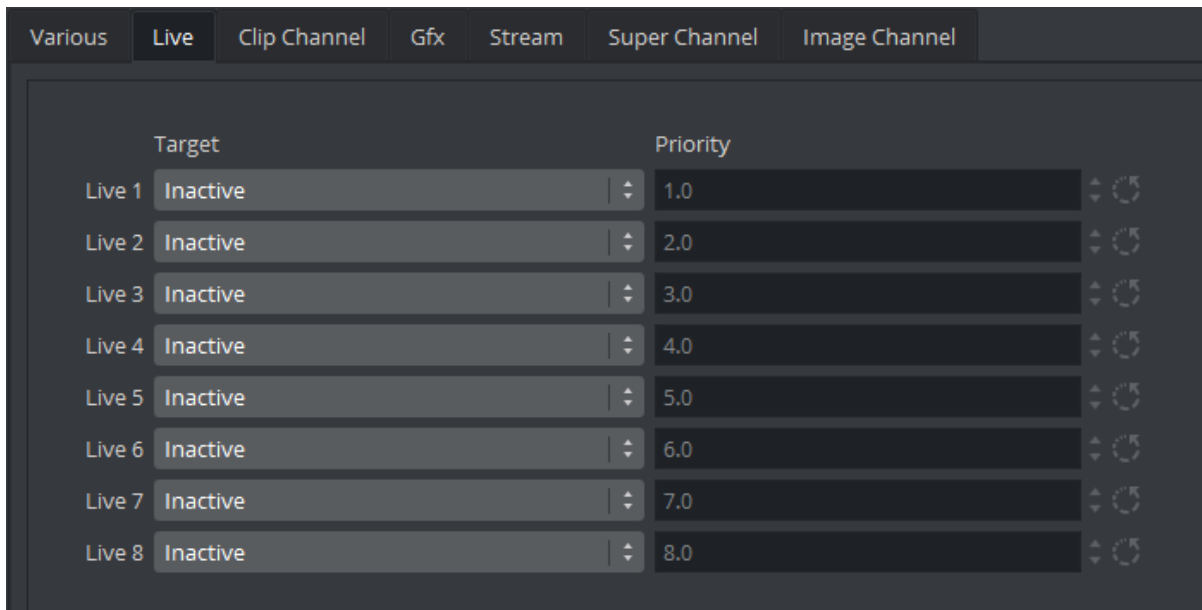

By setting the individual number and type of Media Asset to `Inactive`, `DVE` or `Texture`, the desired channel is automatically set up when dragged into the Scene Tree of new scenes. The priority option works only in DVE mode, and influences the drawing order of the defined channels.



## 8.23 Spaceball

The Spaceball section is used to configure a 3D navigation device.

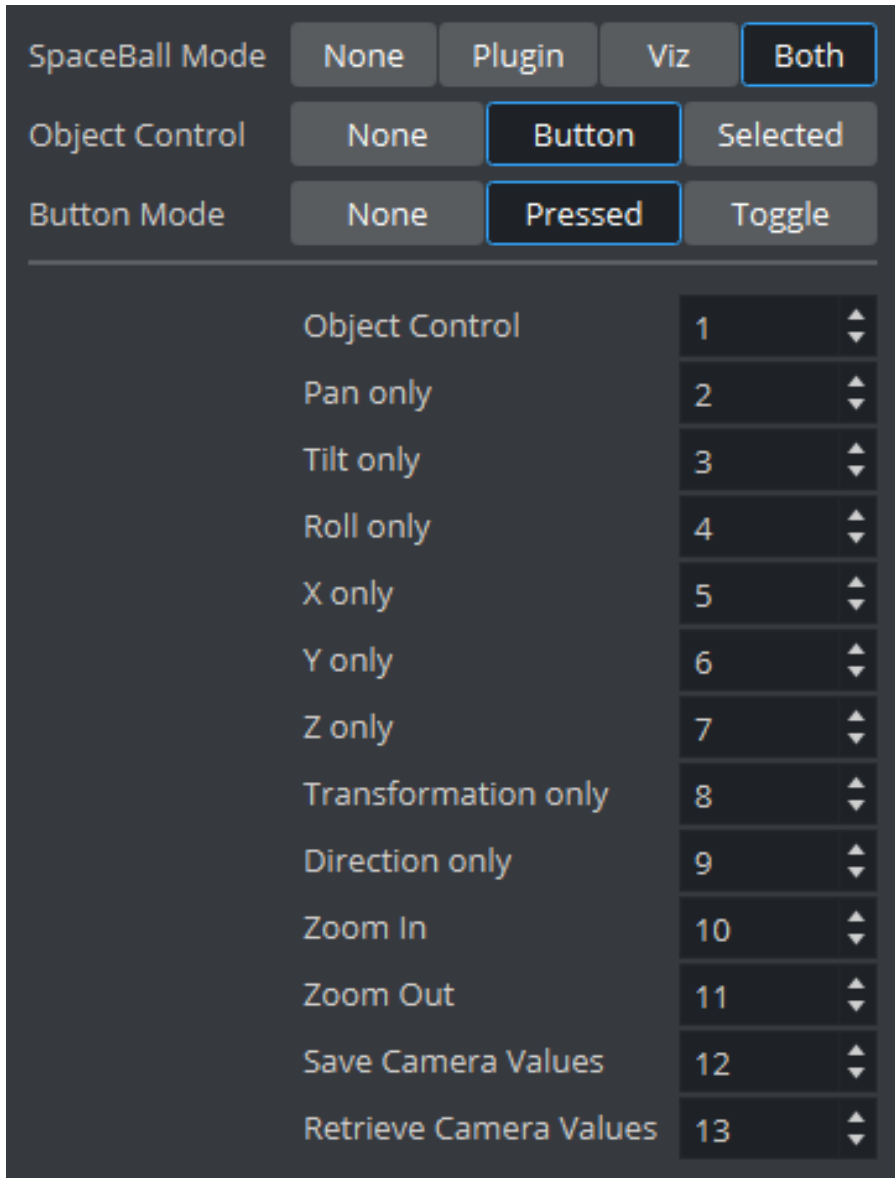

- **SpaceBall Mode:** Sets special setups where the Spaceball should only control specific plug-ins without influencing the scene (objects/camera):
  - **None:** No setup.
  - **Plugin:** Controls plug-ins.
  - **Viz:** Controls Viz Artist/Engine objects.
  - **Both:** Controls both plug-ins and Viz Artist/Engine objects.
- **Object Control:**
  - **None:** No setup.

- **Button:** Uses button for object control.
- **Selected:** Modifies only the selected object.
- **Button Mode:**
  - **None:** No setup.
  - **Pressed:** Triggers an action like a button in a user interface.
  - **Toggle:** Sets a state. When a button is pressed, only the dominant axis is considered in a move, whereas when the button is released all movements are applied.  
The numeric fields are used to map the various buttons on the 3D navigation device. This varies by the vendor and the vendors model; hence, the button numbers need to be looked up in the [Viz Artist User Guide](#) for the respective device.

Button options are:

- Object Control
- Pan Only
- Tilt Only
- Roll Only
- X Only
- Y Only
- Z Only
- Transformation Only
- Direction Only
- Zoom In
- Zoom Out
- Save Camera Values
- Retrieve Camera Values

## 8.24 Unreal Engine

Settings to communicate with and control Unreal Engine.

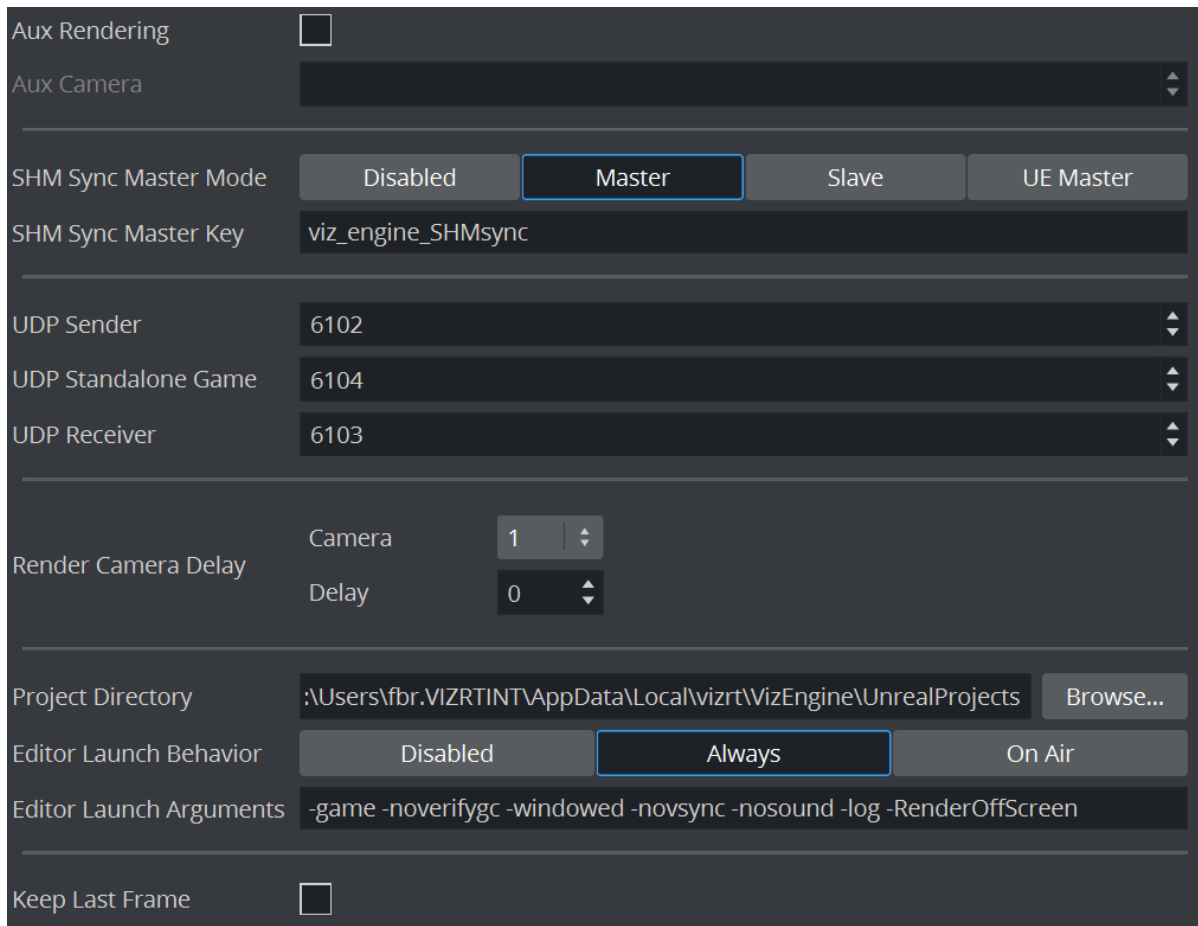

- **Aux Rendering:** Needed for integration with Unreal Engine.
- **SHM Sync Master:** Defines how the synchronization between Viz Engine and Unreal Engine should work.
  - Disabled
  - Master
  - Slave
  - UE Master
- **SHM Master Key:** A unique identifier key.
- **UDP Sender, UDP Standalone Game, and UDP Receiver:** Defines which ports are being used to communicate with Unreal Engine.

A delay in frames can be set for each individual camera. This defines how much delay the Viz camera has to compensate the delay between requesting and retrieving the Unreal Rendering.

**Project Directory** defines the location your unreal projects are located on your hard disk. This location is used when restoring projects from a file collection to a playout machine. **Editor** is the executable that is started if the **Editor Launch Behavior** is set to *Always* or *On Air*.

If a scene has a file collection associated, the unreal project is restored from Graphic Hub to the given **Project Directory**. The **Editor Launch Behavior** defines whether Unreal Editor is launched with the given launch Editor Launch arguments.

- *Always* means that the editor is launched regardless of Viz Engine being in On Air Mode or not (Viz Artist).
- *On Air* only launches the editor if Viz Engine is in playout mode.

**Keep Last Frame:** Displays the last frame rendered instead of turning black (in case the connection is lost).

### 8.24.1 Start/Close Unreal Engine using Viz Engine in On Air Mode

You can start/close Unreal Engine, show FPS and GPU statistics by clicking the **Unreal Control** button.

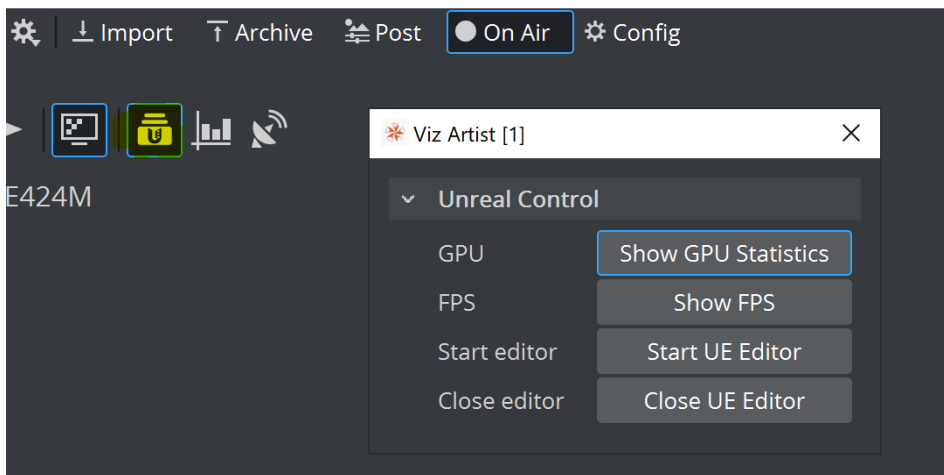

The Start UE Editor button uses the highlighted settings.

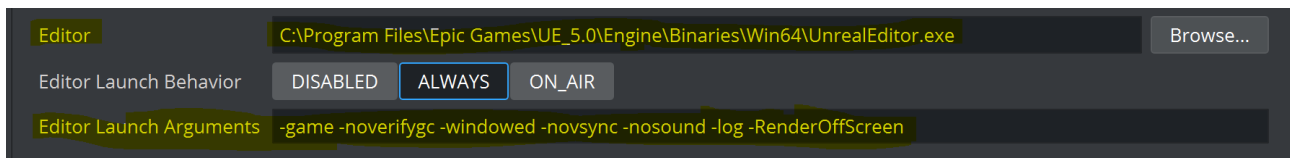

## 8.25 User Interface

This section describes the user interface settings. Some of these settings are also available in Viz Artist.

- [Various](#)
- [Tree Colors](#)
  - [To Change the Amount of Active Colors](#)
- [Shortcuts](#)
  - [To Edit a Shortcut](#)

### 8.25.1 Various

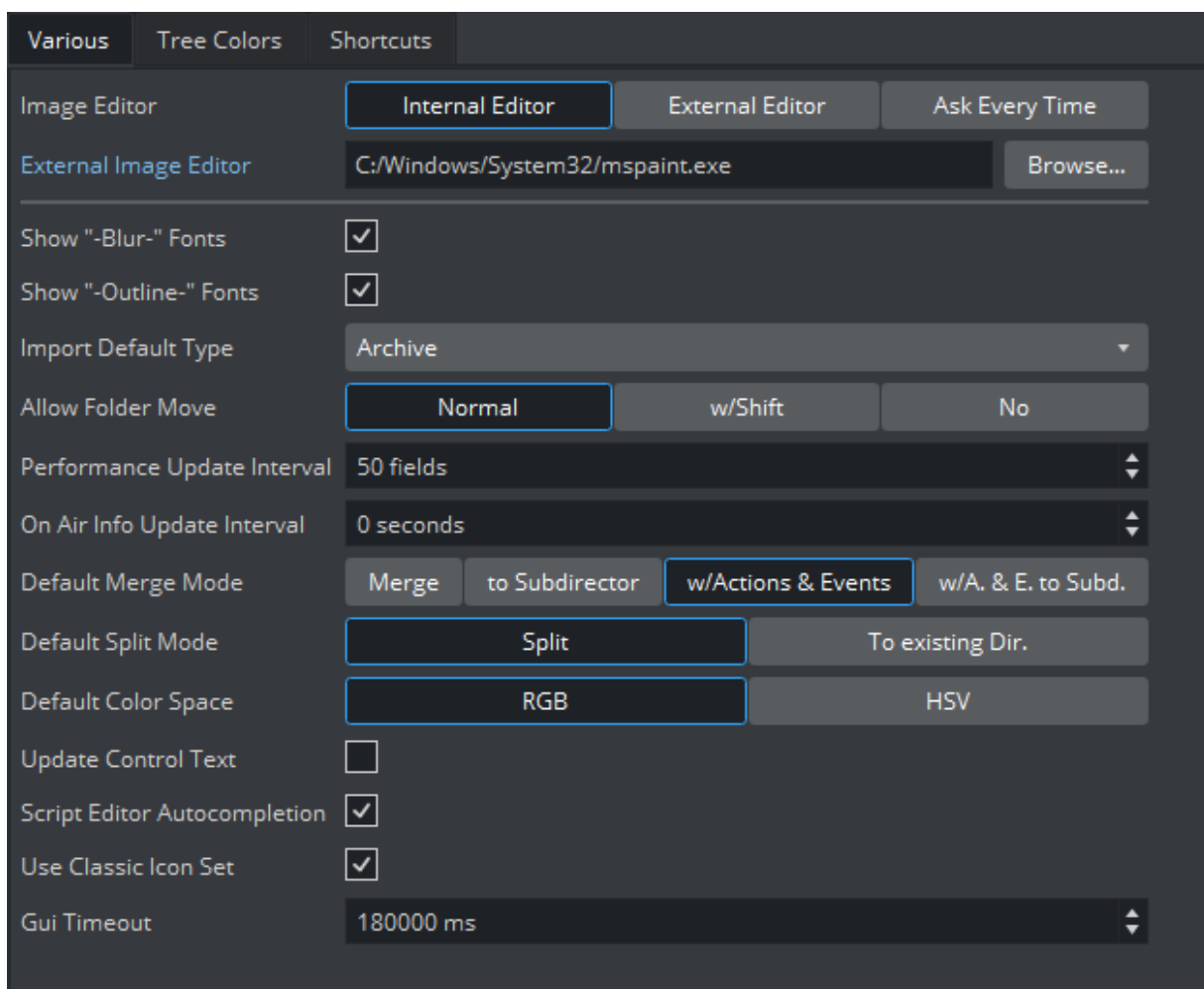

- **Image Editor:** Specifies whether to use the the built-in internal editor, an external editor or to always ask the user which one to use.
- **External Image Editor:** In case you prefer to edit your images not in the internal editor, provide the path to the external executable here.

- **Show “Blur” fonts:** Sets the default show or hide blur fonts in the Server area. The option can then be toggled with the **Item Context Menu** (see the [Viz Artist User Guide](#)).
- **Show “Outline” fonts:** Sets the default for showing or hiding the outline fonts in the Server area. The option can then be toggled with the **Item Context Menu** (see the [Viz Artist User Guide](#)).
- **Import Default Type:** Selects the default item type for imports, which is pre-selected in the GUI **Import Menu**. Options are:
  - **Fonts**
  - **Images**
  - **Geometries**
  - **Scenes**
  - **Audio**
  - **Archives**
- **Allow Folder Move:** Allows or restricts the user’s ability to move/organize projects and folders in a Graphic Hub. Options:
  - **Normal:** Drag folders freely, as required to move (Default setting).
  - **w/Shift:** Press **SHIFT** and drag to move folder or folders.
  - **No:** No folder movement allowed.
- **Performance Update Interval:** Sets how often Viz Engine should update the Performance Bar when it is opened.
- **On Air Info Update Interval:** Sets the update interval for the [On Air Information Panel](#) window. Note that a shorter interval decreases render performance. Setting to **0** means that no update occurs.
- **Default Merge Mode:** Sets the default merge behavior available in the Viz Artist user interface. Options are:
  - Merge
  - [Merge] to sub director
  - [Merge] w/actions & events
  - [Merge] w/actions and events to sub director (*w/A. & E. to Subd.*)
- **Default Split Mode:** Sets the default split behavior available in the Viz Artist user interface. Options are:
  - Split
  - [Split] to existing director
- **Default Color Space:** Selects RGB or HSV as the default color space for the Material editor
- **Update Control Text:** Makes Update Control Text active or inactive:
  - **Active:** Updates the Control text in Control Objects with every key stroke.
  - **Inactive:** Does not update the Control text in Control Objects with every key stroke.
- **Script Editor Autocomplete:** Toggles the autocomplete suggestions inside the script editor.
- **Use Classic Icon Set:** Uses the legacy icon set.
- **Gui Timeout (ms):** Defines the timeout threshold in milliseconds when awaiting command replies from the Engine. After the specified time, a timeout dialog is displayed. The minimum and default value **180000** , or 180 seconds.



**Tip:** Adjust the timeout value if timeouts occur when loading very large scenes in Viz Artist.

## 8.25.2 Tree Colors

The Colors tab gives the ability to change the colors for containers in the Scene Tree. A Container with a color code can be used as search criteria in the Scene Tree (see **Scene Tree Menu** in the [Viz Artist User Guide](#)).

**Example:** All text Containers can be colored gray and tagged Text, while all Containers that hold images can be colored green and tagged Image, and so on.

Four colors are configured and active by default with no text descriptions. Click **Set to Default** to set all color bars to their default setting. The color options are available in the GUI **Scene Settings** panel in the Tree Color Text setting, and available for use in the Scene Tree panel.

Use the **Highlight Complete Container** setting to select either the whole container or only a small stripe on the left side.

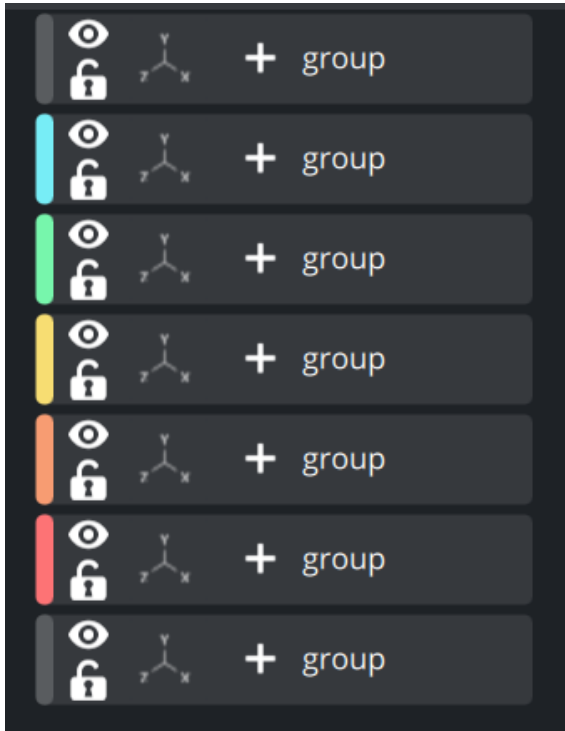
Highlight Container Setting	
Highlight Complete Container <input checked="" type="checkbox"/> ON	Highlight Complete Container <input type="checkbox"/> OFF
	



Click **Save** then restart Viz Artist for the changes to take effect.

### To Change the Amount of Active Colors

In the **Active Colors** field enter the amount of colors to be active. Up to 16 colors can be configured and made active.

### 8.25.3 Shortcuts

The shortcuts view shows all available shortcuts and their current mappings. Shortcuts can be modified and exported for personalization.

**Note:** Some shortcuts can not be modified, they are displayed in a slighter darker grey.

Shortcuts are grouped by their editors:

- General Application
- Archive View
- Asset View



- Import
- On Air + Render Editor
- Plugin List View
- Scene Editor
- Scene Tree
- Script Editor
- Stage
- Stage Tree

**Note:** On Air (Viz Artist) and Render Editor (Viz Engine) share the same functionality, however Render Editor shortcuts can be mapped different to achieve different behavior (for example, in videowall mode).

Action	Keybinding	Group
Open Viz Artist Documentation	F1	Application
Switch to Configuration View	F12	Application
Redo	CTRL + Y	Application
Switch to Import View	F8	Application
Switch to On Air View	F11	Application
Switch to Workspace View	F7	Application
Quit Viz Artist	ALT + Q	Application
Extend Selection Left	SHIFT + Left	Application
Switch to Post-Render View	F10	Application
Switch to Archive View	F9	Application
Save Scene	CTRL + S	Application
Show Video Output Configuration Window	ALT + V	Application
Show Viz Command Console	ALT + C	Application
Navigate Up	Up	Application
Navigate Down	Down	Application
Scroll Page Down	PgDown	Application
Navigate Left	Left	Application
Navigate Right	Right	Application
Undo	CTRL + Z	Application
Navigate Right Alt	CTRL + Right	Application
Navigate Up Alt	CTRL + Up	Application
Extend Selection Down	SHIFT + Down	Application
Scroll Page Up	PgUp	Application
Navigate Down Alt	CTRL + Down	Application

## To Edit a Shortcut

If a shortcut can be modified, an icon () is shown in the left row. Select it to show the dialog, or double click on the entry.

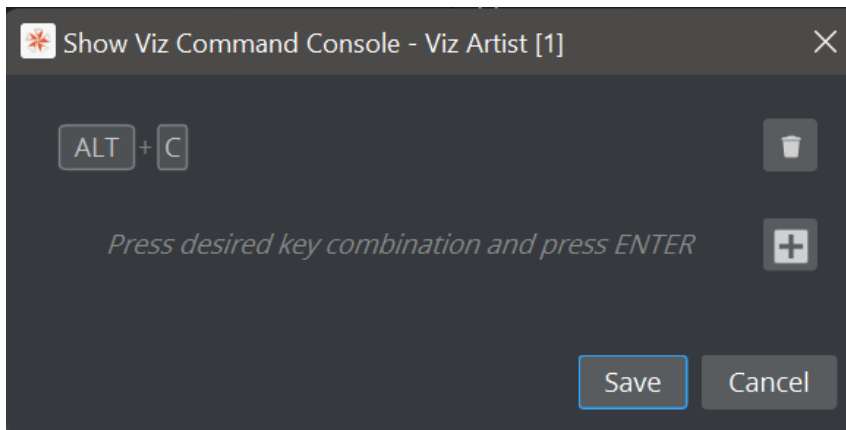

If you want to add an additional shortcut, press the desired combination and press the add (+) button. To remove a shortcut, press the trashcan (🗑️) button.

## 8.26 Video Board

This section is used to configure video input, output and clip playback related settings.

### 8.26.1 Video Board Properties

Loopthrough Delay (EE)

**⚠** Using a minimum delay of 7 frames, either by enabling 'Use Minimum Delay' or setting it to 7 frames, causes load spikes to result in frame drops quickly.

Use Minimum Delay

Output Delay

Use Watchdog

Watchdog Timeout

Watchdog Mode

Watchdog Reactivation

Check Video Card Bluefish  Aja  Matrox  User Defined

Software I/O Mode

Inline Video Mixer

Inline Audio Mixer

Loopthrough Delay (EE)

Videout Ring Buffer

Ring Buffer Size

Use Watchdog

Watchdog Timeout

Watchdog Mode

Watchdog Reactivation

Check Video Card Bluefish  Aja  Matrox  User Defined

Software I/O Mode

- **Loophrough Delay (EE):** Sets the delay for live video input (Bluefish boards only). This setting applies for all input channels. For Matrox, see Video Delay DVE in Video Properties.
- **Use Minimum Delay/Output delay:** Sets the number of frames between the earliest possible start of rendering and sending the frame. This mechanism is used with Matrox video boards, DSX Core, and software I/O mode NDI. The output delay includes the time for rendering, transfer of data from the GPU, and processing on the video board if required. The minimum output delay reserves one video unit for rendering. Using a higher output delay allocates the additional time to rendering. This can compensate for load spikes and prevent frame drops.

The minimum delay depends on these factors:

- **Matrox:** The hardware mixer of X.mio cards is the most important factor. If enabled, the minimum delay output delay is five frames in interlaced and six frames in progressive. This is necessary to synchronize DVE effects with graphics. If the hardware mixer is disabled or a DSX LE card is use, the minimum delay is two video units.
  - ⚠ The following settings increase the minimum delay by one additional frame:
    - Using UHD resolutions on an X.mio3 or DSX LE4 card.
    - Enabling clean feed.
  - **DSX Core:** The minimum delay is seven frames in interlaced and eight frames in progressive.
  - **NDI:** The minimum delay is two video units.
- **Videoout Ring Buffer:** This mechanism is used by all video classes that do not use the output delay. It sets the render buffer for video output. Helps to prevent frame drops on the video output during execution of commands or loading of objects. When enabled, the engine renders a number of graphics frames in advance and provide it to the video hardware. The number of frames rendered forwardly is defined by the ring buffer Size. Large buffer sizes delay the output and increase the input to output delay for video textures.
- **Ring Buffer size:** Sets the size of the ring buffer in frames.
- **Use Watchdog:** Activates or deactivates the watchdog functionality.
  - **Matrox:** See **Video IO Related Configuration and Features > Matrox Watchdog Configuration** in the [Viz Engine Administrator Guide](#).
  - **Bluefish:** See **Hardware Related Information > Video Boards > BlueFish444 > Special Configuration Options for Bluefish444** in the [Viz Engine Administrator Guide](#).
- **Watchdog Timeout:** Sets the time, in milliseconds, until the watchdog takes over control. This value should not be smaller than the time of two fields/frames. Default value is `999 ms`.
- **Watchdog Mode:** Sets the Watchdog mode:
  - **First Geom Load:** Activates Video Out when the first geometry is loaded.
  - **At Startup:** Activates Video Out at startup.
  - **First Geom Load/DVE:** Activates Video Out when the first geometry is loaded or an input or clip channel is set to DVE.
- **Watchdog Reactivation:** Activates the watchdog again if scenes are unloaded from renderer when set to `On`.
- **Check Video Card:** Selects which video cards to search for and use when Viz Artist/Engine is started. If a video card is not selected it is not used, even if it is installed in the system. All cards are enabled by default.

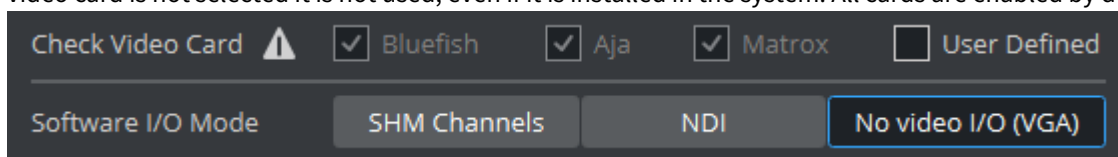

- **Select Individual Cards:** Selects/deselects video cards if **User Defined** is selected. Click on each listed card to select or deselect, as required.
- **User Defined:** Selects and uses individual cards.
- **None:** Makes all all connected video cards unavailable for Viz Engine and Viz Artist when selected. This can be used to run a Viz Artist for a different video platform version, even if video cards are installed. Possible use-cases for this are:
  - Dual channel Viz Trio One Boxes, which have three Viz Artist/Engine instances running and where only the first two should use the video board. The third Engine instance is exclusively for Viz Trio preview.
  - With TriCaster implementation.
- **Software I/O Mode:** Sets a specific Video I/O mode for setups without video hardware or configurations where **Check Video Card** is set to **None** .
  - **SHM Channels:** Sets I/O mode for third party software, utilizing the Viz SHMLib software library.
  - **NDI:** Uses the NewTek NDI input and outputs. Read more about using NDI with Viz Engine and Artist in the Third Party Applications and Files chapter of the [Viz Artist User Guide](#).
  - **No video I/O (VGA):** Disables all video version features, emulating the deprecated VGA version of Viz Engine.
- **Inline Video and Audio mixer:** Enables the zero frame delay mixer, which means that the surface (and audio) is copied directly from the input to the output.

*Auto*, the configured output resolution will be used. In case of a video wall setup (full screen or custom resolution), *Auto* falls back to 1080i and must be reconfigured if a different resolution is required.



**⊗ Caution:** Depending on various factors like used codec, disk performance, current load of the system, and more, not all of the Clip Channels might be usable for production. This might be different from system to system. Please test the scene and the system's overall performance before taking a scene On Air.

## 8.26.2 Clip Input Properties

*Auto*, the configured output resolution will be used. In case of a video wall setup (full screen or custom resolution), *Auto* falls back to 1080i and must be reconfigured if a different resolution is required.



**⊗ Caution:** Depending on various factors like used codec, disk performance, current load of the system, and more, not all of the Clip Channels might be usable for production. This might be different from system to system. Please test the scene and the system's overall performance before taking a scene On Air.

## 8.26.3 Clip Input Properties

## 8.27 Video Input: Clip Input

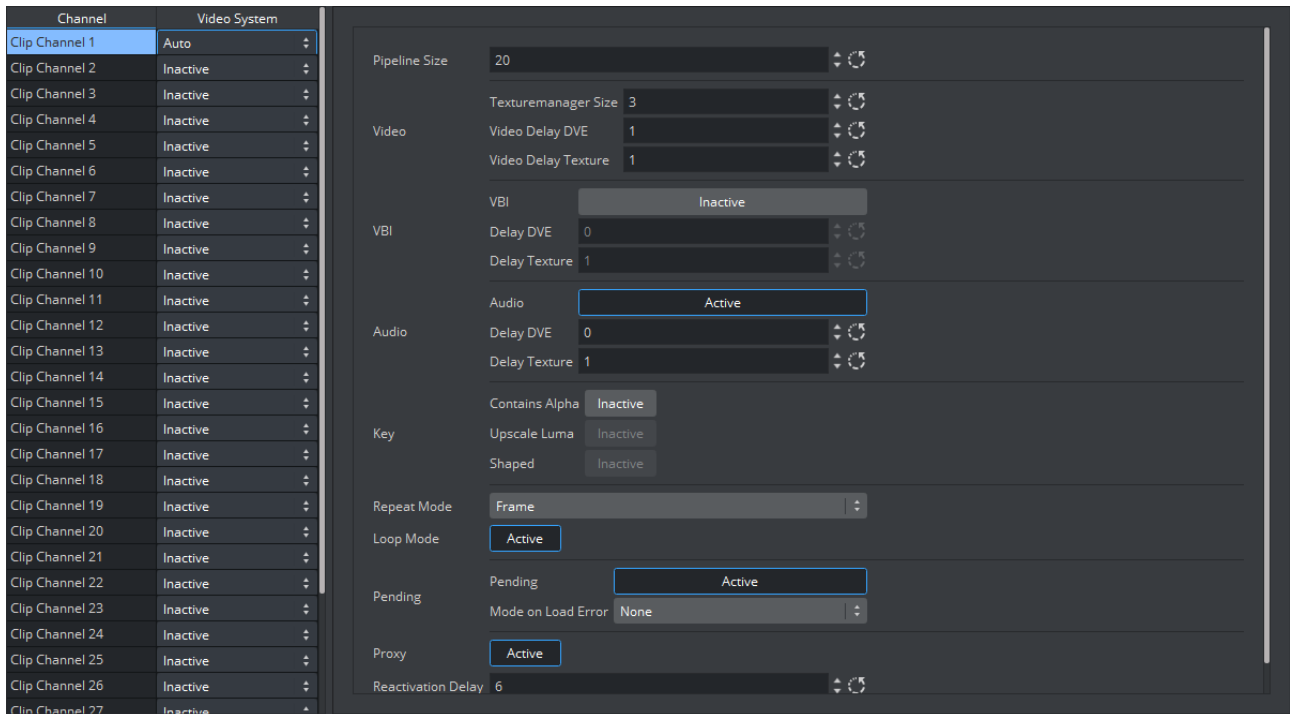

Use the Video Input: Clip Input panel to configure available playback channels. The left hand pane defines the number of usable clip channels and their respective resolution. If the Video System is set to *Auto*, the configured output resolution will be used. In case of a video wall setup (full screen or custom resolution), *Auto* falls back to 1080i and must be reconfigured if a different resolution is required.

**⊗ Caution:** Depending on various factors like used codec, disk performance, current load of the system, and more, not all of the Clip Channels might be usable for production. This might be different from system to system. Please test the scene and the system's overall performance before taking a scene On Air.

### 8.27.1 Clip Input Properties

- **Pipeline Size:** Defines the number of frames that the Matrox internal clip reader buffer should buffer in advance. Default value is `20`.
- **Texturemanager Size:** Sets texture download buffer size.
- **Video Delay DVE:** Sets DVE Delay of video when used as DVE.
- **Video Delay Texture:** Sets texture Delay of video when used as Texture.
- **VBI:** Defines whether VBI should be used for this channel. Set to Active or Inactive. Default mode is `Inactive`.
- **Delay DVE:** Sets the number of frames VBI should be delayed, before the clip can be used, in DVE mode. Default value is `0` (Off).

- **Delay Texture:** Sets the number of frames VBI should be delayed, before the clip can be used, in texture mode. Default value is `1`.
- **Audio:** Enables/disables audio for this channel. When set to `Inactive`, audio is disabled. Default value is `Active`.
- **Delay DVE:** Sets the number of frames the audio clip should be delayed in DVE mode before it can be mixed to the output. Default value is `4`.
- **Delay Texture:** Sets the number of frames the audio clip should be delayed in texture mode before it can be mixed to the output. Default value is `4`.
- **Contains Alpha:** Enables/disables playback of clips with alpha.
- **Upscale Luma:** Enables/disables the default for upscale luma. Per scene setting of this value is set per clip channel under Scene Settings and Video clip options.
- **Shaped:** Defines whether the fill from this channel, when the channel is used in DVE mode, should be interpreted as shaped video during DVE compositing. Default value is `Inactive`.
- **Repeat Mode:** Determines the behavior of the video input in case of capture drops. Options are:
  - **None:** Does not repeat. Input goes black.
  - **Field:** Repeats the last field.
  - **Frame:** Repeats the last frame.
- **Loop Mode:** Enables/disables default for loop mode. Per scene setting of this value is set per clip channel under Scene Settings and Video clip options.
- **Pending Enable:** Enables/disables pending clip player for this channel. The pending clip player allows clip loading of another clip while the clip channel is still using the current clip.
- **Mode on Load Error:** Determines the behavior of the current clip when loading of the pending clip fails. Options are:
  - **None:** Current clip mode is not changed.
  - **Stop:** Performs a Stop command on the current clip.
  - **Pause:** Current clip enters pause mode.
  - **Flush:** Unloads the current clip.
- **Proxy:** Allows playing video clips of a resolution different to the current configured resolution when set to `Active`. If set to `Inactive`, a video clip of a different resolution cannot be played.
- **Reactivation Delay:** Sets the minimum number of frames the texture contains black after the channel was activated to texture.
- **Delay After Input Graph:** Adds a surface delay to compensate the time needed for pose estimation.

#### See Also

- [Matrox](#)

## 8.28 Video Input: Live Input

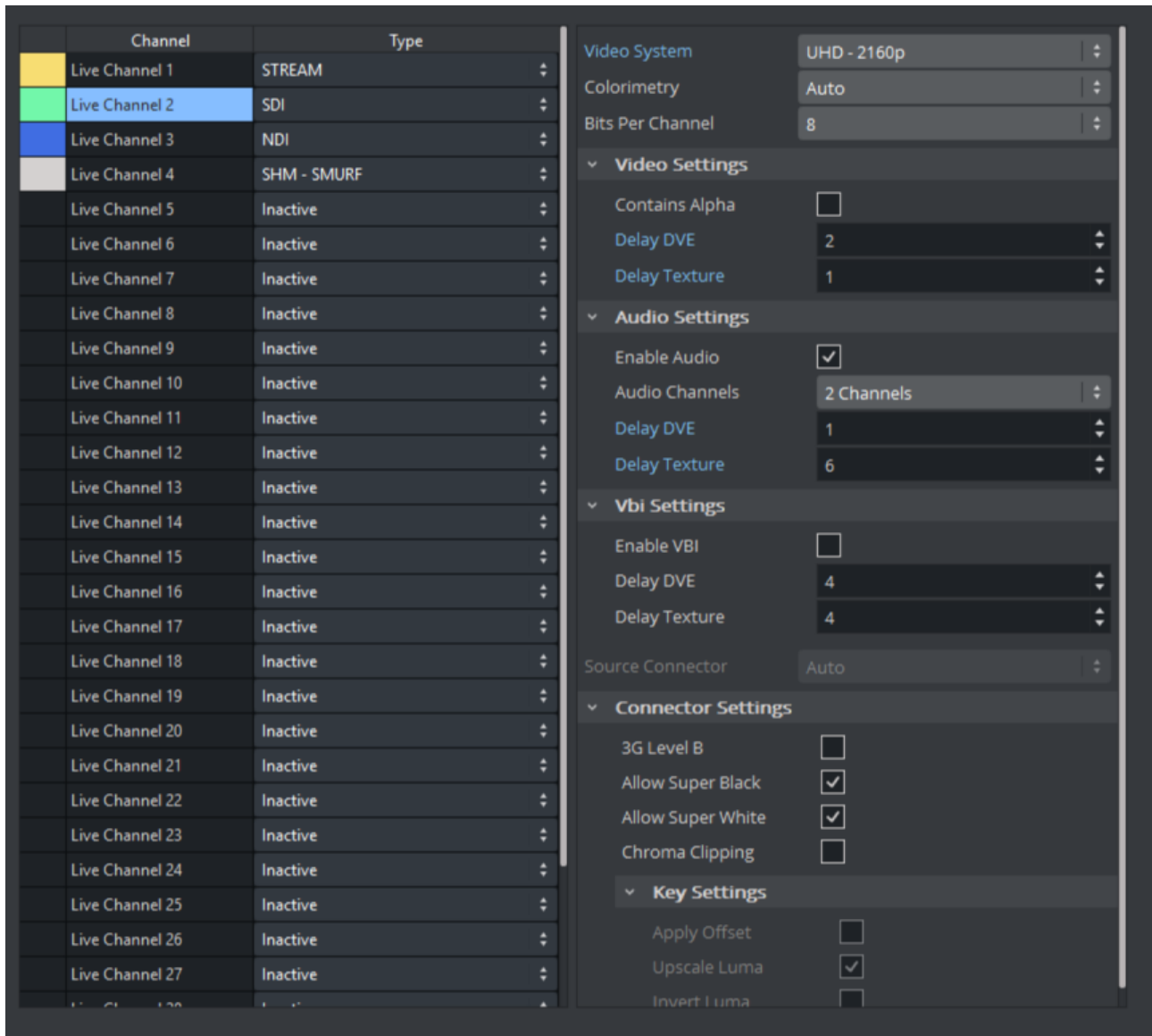

Channel	Type
Live Channel 1	STREAM
Live Channel 2	SDI
Live Channel 3	NDI
Live Channel 4	SHM - SMURF
Live Channel 5	Inactive
Live Channel 6	Inactive
Live Channel 7	Inactive
Live Channel 8	Inactive
Live Channel 9	Inactive
Live Channel 10	Inactive
Live Channel 11	Inactive
Live Channel 12	Inactive
Live Channel 13	Inactive
Live Channel 14	Inactive
Live Channel 15	Inactive
Live Channel 16	Inactive
Live Channel 17	Inactive
Live Channel 18	Inactive
Live Channel 19	Inactive
Live Channel 20	Inactive
Live Channel 21	Inactive
Live Channel 22	Inactive
Live Channel 23	Inactive
Live Channel 24	Inactive
Live Channel 25	Inactive
Live Channel 26	Inactive
Live Channel 27	Inactive
Live Channel 28	Inactive

**Video System** UHD - 2160p

**Colorimetry** Auto

**Bits Per Channel** 8

**Video Settings**

- Contains Alpha
- Delay DVE 2
- Delay Texture 1

**Audio Settings**

- Enable Audio
- Audio Channels 2 Channels
- Delay DVE 1
- Delay Texture 6

**Vbi Settings**

- Enable VBI
- Delay DVE 4
- Delay Texture 4

**Source Connector** Auto

**Connector Settings**

- 3G Level B
- Allow Super Black
- Allow Super White
- Chroma Clipping

**Key Settings**

- Apply Offset
- Upscale Luma
- Invert Luma

Use the Video Input: Live Input panel to configure channels utilizing external sources. The left hand pane defines the number of usable channels and their type. Depending on the video hardware you're using, the available types are:

- SDI
- IP (SMPTE ST 2110 or ST 2022-6)
- STREAM
- NDI
- Various Shared Memory inputs



**Information:** The number of usable channels depends mainly on the installed video hardware.

### 8.28.1 Live Input Properties: Type SDI

- **Video System:** Either the required resolution or *Auto* to use the configured output resolution. In case of a video wall setup (full screen or custom resolution), *Auto* falls back to 1080i and must be reconfigured if a different resolution is required.
- **Colorimetry:** This setting is only relevant for HDR workflows and available for resolutions from 1080p upwards. Available options are:
  - *ITUR\_BT\_709*
  - *ITUR\_BT\_2020*
  - *ITUR\_BT\_2100\_HLG*
- **Bits per channel:** Defines how many bits per channel are processed for an input.

**Note:** Bits per channel is not supported on SD channels.

- **Video Settings**
  - **Contains Alpha:** Enables alpha for this input. Only available on connectors that have an associated alpha connector.
  - **Delay DVE:** Sets DVE Delay of video when used as DVE.
  - **Delay Texture:** Sets texture Delay of video when used as Texture.

**Note:** Setting the texture delay of progressive inputs to 1 frame has a performance impact that scales with the aggregate bandwidth of the input signals.

- **Audio Settings**
  - **Enable Audio:** Toggles audio for this channel. When set to *Inactive*, audio is disabled. Default value is *Active*.
  - **Audio Channels:** Defines the number of Audio Tracks to be used on the channel. The number of available track configurations is dependent on the Video hardware being used.
  - **Delay DVE:** Sets the number of frames the audio clip should be delayed in DVE mode before it can be mixed to the output. Default value is 4.
  - **Delay Texture:** Sets the number of frames the audio clip should be delayed in texture mode before it can be mixed to the output. Default value is 4.
- **VBI Settings**
  - **Enable VBI:** Defines whether VBI should be used for this channel. Set to *Active* or *Inactive*. Default mode is *Inactive*.
  - **Delay DVE:** Sets the number of frames VBI should be delayed before the clip can be used in DVE mode. Default value is 0 (Off).
  - **Delay Texture:** Sets the number of frames VBI should be delayed before the clip can be used in texture mode. Default value is 1.

- **Source Connector:** Replaces *Map To Viz Channel* and assigns the selected physical connector to that channel.
- **Expert Settings**
  - **Delay After Input Graph:** Adds a surface delay to compensate the time needed for pose estimation.
- **Multiconnector Mode:** Defines which type of multiconnector mode is used when performing quad UHD or "None" in case a 12G channel is in use (A, B, C, D). Additionally, only channels A, E and I are allowed by Viz Engine to change this mode, although channels E and I can have only 2SI or Square Division set. Default value is *None* for channel A and *2SI* for E and I. Otherwise this control disabled. Only available when using an X.mio5 12G card and Video System is configured to an UHD resolution.
- **Connector Settings**
  - **3G Level B:** Toggles the Level B on that connector if configured to 1080p or higher.
  - **Allow Super Black:** Toggles super black on this connector.
  - **Allow Super White:** Toggles super white on this connector.
  - **Chroma Clipping:** Toggles chroma clipping on this connector.

## 8.28.2 Live Input Properties: Type IP

- **Video System:** Either the required resolution or *Auto* to use the configured output resolution. In case of a video wall setup (full screen or custom resolution), *Auto* falls back to 1080i and must be reconfigured if a different resolution is required.
- **Colorimetry:** This setting is only relevant for HDR workflows and available for resolutions from 1080p upwards. Available options are:
  - *ITUR\_BT\_709*
  - *ITUR\_BT\_2020*
  - *ITUR\_BT\_2100\_HLG*
- **Bits per channel:** Defines how many bits per channel are processed for an input. This is not supported on SD channels!
- **Video Settings**
  - **Contains Alpha:** Enables alpha for this input. Only available on connectors that have an associated alpha connector.
  - **Delay DVE:** Sets DVE Delay of video when used as DVE.
  - **Delay Texture:** Sets texture Delay of video when used as Texture.



**Note:** Setting the texture delay of progressive inputs to **1** frame has a performance impact that scales with the aggregate bandwidth of the input signals.

- **Audio Settings**
  - **Enable Audio:** Toggles audio for this channel. When set to **Inactive**, audio is disabled. Default value is **Active**.
  - **Audio Channels:** Defines the number of Audio Tracks to be used on the channel. The number of available track configurations is dependent on the used Video hardware.
  - **Delay DVE:** Sets the number of frames the audio clip should be delayed in DVE mode before it can be mixed to the output. Default value is **4**.

- **Delay Texture:** Sets the number of frames the audio clip should be delayed in texture mode before it can be mixed to the output. Default value is `4`.
- **VBI Settings**
  - **Enable VBI:** Defines whether VBI should be used for this channel. Set to Active or Inactive. Default mode is `Inactive`.
  - **Delay DVE:** Sets the number of frames VBI should be delayed, before the clip can be used, in DVE mode. Default value is `0` (Off).
  - **Delay Texture:** Sets the number of frames VBI should be delayed, before the clip can be used, in texture mode. Default value is `1`.
- **Source Connector:** Replaces *Map To Viz Channel* and assigns the selected physical connector to that channel.
- **Expert Settings**
  - **Delay After Input Graph:** Adds a surface delay to compensate the time needed for pose estimation.
- **Connector Settings**
  - **Allow Super Black:** Toggles super black on this connector.
  - **Allow Super White:** Toggles super white on this connector.
  - **Chroma Clipping:** Toggles chroma clipping on this connector.

**Warning:** Although any Source Connector chosen here is correctly saved, when Viz Engine starts, it checks whether the available bandwidth in the SFP's allows this configuration to be used. In case an SFP doesn't have enough bandwidth, Viz Engine tries to use the first available connector in the other SFP (if it is available). If the other SFP doesn't have enough available bandwidth either, this channel is completely discarded.

**Important:** If the bandwidth is exceeded or to move an input explicitly to the second SFP pair, see [Explicit Usage of the Second SFP Pair on Matrox X.mio5 Q25](#) for more details.

### 8.28.3 Live Input Properties: Type STREAM

- **Video System:** Either the required resolution or *Auto* to use the configured output resolution. In case of a video wall setup (full screen or custom resolution), *Auto* falls back to 1080i and must be reconfigured if a different resolution is required.
- **Stream Settings**
  - **Enable Audio:** If audio should be received or not
  - **URL:** URL of the stream in the format `[protocol]://@ip:port`. Possible protocol values are *RTP*, *RTSP*, *RTMP*, *UDP*, and *SRT* (for example, `udp://@239.0.1.10:50202`).
  - **NIC Address:** NIC that is receiving the stream.
- **RTSP and RTMP Settings:**
  - **SRC UDP Port:** Source port only used for RTSP. Must be different for every active RTPS stream.
- **SRT Settings:**
  - **Connection Mode**
  - **Remote URL and Password**
  - **Seconds To Wait For Connection:** Seconds to wait until a connection approach is being aborted, Latency in Ms.

- **Access Unit Aligned Input:** If `true`, the user application provides the decoder with data that is aligned on an access unit. Use if there are artifacts in input due to Open GOP.
- **Disable AV Sync:** Disables AV Sync. When there is no audio in the stream, this must be manually set to `true`.
- **Use SW Decoding:** Forces the use of Software Decoding even if M264 is available.
- **Expert Settings**
  - **Delay After Input Graph:** Adds a surface delay to compensate the time needed for pose estimation.

#### 8.28.4 Live Input Properties: Type NDI

- **Video System:** Either the required resolution or *Auto* to use the configured output resolution. In case of a video wall setup (full screen or custom resolution), *Auto* falls back to 1080i and must be reconfigured if a different resolution is required.
- **NDI Settings**
  - **Enable Audio:** If audio should be received or not
  - **Source:** The URL of the NDI source to be used.
- **Expert Settings**
  - **Delay After Input Graph:** Adds a surface delay to compensate the time needed for pose estimation.

#### 8.28.5 Live Input Properties: Type SHM - SMURF

- **Video System:** Either the required resolution or *Auto* to use the configured output resolution. In case of a video wall setup (full screen or custom resolution), *Auto* falls back to 1080i and must be reconfigured if a different resolution is required.
- **SHM Settings**
  - **Enable Audio:** If audio should be received or not
  - **SHM Key:** Shared Memory Key to be accessed.

#### 8.28.6 Mapping of Legacy StreamIn Channels

When using a configuration file created by Viz Engine versions 3.14.1 and older (StreamIn channels are part of the configuration file), the corresponding stream input channels are mapped to live input channels 9 and upwards by default, to avoid conflicts with existing live input channels.

This behavior can be overwritten to start the re-mapping at live in channel 1 by setting the following configuration flag: `no_stream_channel_mapping_offset = 1`.

 **Note:** To make the flag visible in the configuration file, Viz Engine needs to be started with `VerboseConfig = 1` once.

#### See Also

- [Matrox Stream](#)

## 8.29 Video Output

Use the Video Output section to configure special settings for video output, such as SPG settings and so on.

### 8.29.1 Video Output Properties

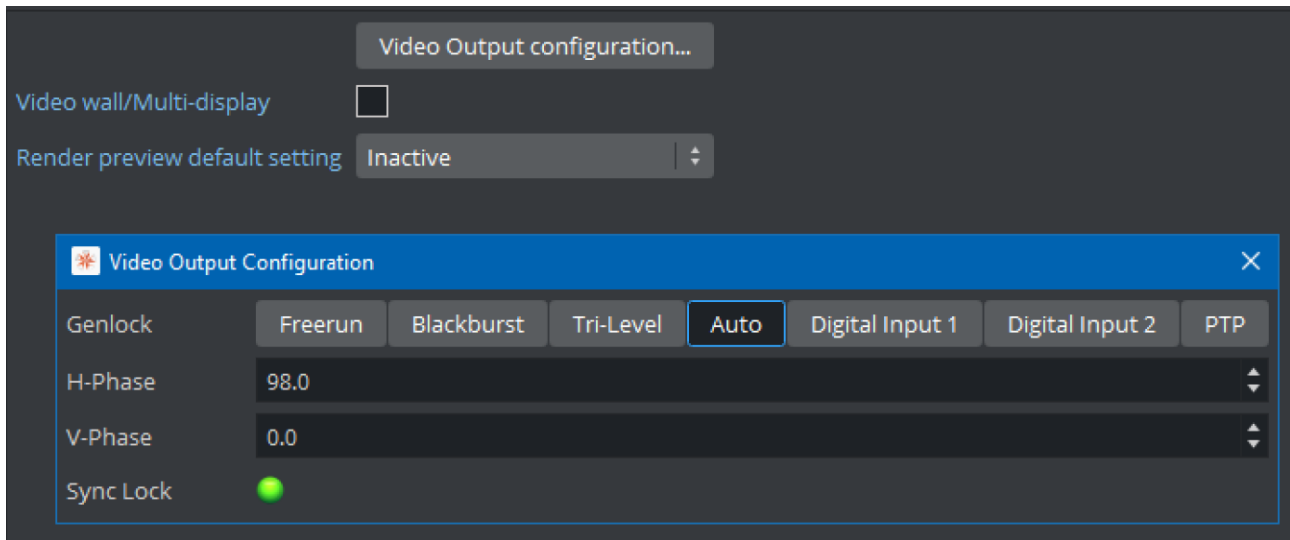

- **Show Video Output Config. Editor:** Opens the Video Output Editor. You can also open the Video Output Editor by pressing **ALT + V**.
- **Video wall/Multi-display:** Sets the main output to the Digital Visual Interface (DVI).

**✘ Important:** For videowall setups, this setting must be active and the output format must be set to **FULLSCREEN**.

- **Render preview default setting:** Sets the default value for the Preview button (see [Control Buttons](#)) when Viz Engine is in On Air mode.
  - **Inactive:** Renders only video out signals. This increases performance, as the renderer does not have to render into an editor on-screen and into pixel buffer.
  - **Active:** Renders both video out signals and on-screen (this decreases performance).
  - **Fullscreen:** Sets the On Air window to screen size.

### 8.29.2 Video Output Editor

The Video Output Editor defines the synchronization standard and the output signal phases.

- **Freerun:** Locks Viz Engine to a clock signal on the video board.
- **Blackburst:** Locks Viz Engine to a Blackburst GenLock signal.
- **Tri-level:** Locks Viz Engine to a Tri-Level GenLock signal.
- **Auto:** Auto detects the genlock signal and locks to it.
- **Digital Input 1 and 2:** Locks Viz Engine to the signal on Input 1 or 2.

- **PTP:** Uses a Precision Time Protocol source for synchronizing. Mainly used in IP networks.
- **H-Phase and V-Phase:** Shifts the output signal with respect to the sync signal.

 **Note:** The *Auto* option is only available on Matrox boards. On Matrox boards the h- and v-phase settings are updated automatically with default values based on the output resolution (Except IP based cards). It is still needed to measure the exact h- and v-phase for each setup.

## To Make the V- and H-Phase Values Coincide

1. Set the **V-phase value**.
  - The *V-granularity* is taken from the genlock.
  - The *V-delay* is calculated from  $V\text{-phase} * V\text{-granularity}$ .
  - The genlock is set with this *V-delay*.
2. Set the **H-phase value**. Note that there is a distinction whether the H-phase is a positive or a negative value.
  - If the **H-phase > 0**
    - The genlock *H-delay* is set to 0 .
    - The *H-granularity* is taken from the video out channel.
    - The *H-delay* is calculated from  $H\text{-phase} * H\text{-granularity}$ .
    - The fill and key channels are set with this *H-delay*.
  - If the **H-phase <=0**
    - The fill and key channel *H-delay* is set to 0 .
    - The *H-granularity* is taken from the genlock.
    - The *H-delay* is calculated from  $- H\text{-phase} * H\text{-granularity}$ .
    - The genlock is set with this *H-delay*.

 **Note:** The granularity and possible min/max values are printed to the Viz Artist/Engine console during startup.

It should be taken into account that when the genlock video format is different from the fill/key video format the value of the *V-delay* matches the genlock lines and not the video output lines. The same applies to *negative H-phase* values.

### See Also

- [Output Format](#)
- [Video Input Clip Input](#)
- [Video Input Live Input](#)

## 8.30 Video Output: Clip Output

Matrox Clip Out channel writes surfaces from your Matrox device into clip files. This can be used for example to record your output into a single clip file.

- [To Configure Clip Output](#)
- [Clip-out Channel Placeholders](#)
- [Sample Commands](#)
  - [1080i50 A MPEG-2 Codec / MpegIframe422ProfileHighLevel\\_WithAlpha with a Bitrate of 150 and 16 Channel Audio](#)
  - [1080p50 Video AVC-Intra Encoder / AVCIntraClass50 with Timecode, No Audio](#)
  - [720p DVCPRO 100 Codec / D12\\_720\\_4to3\\_422\\_Fr1 Four Channel Audio](#)
  - [UHD 2160p XAVC Eight Channel Audio with M264 Encoder](#)

### 8.30.1 To Configure Clip Output

In the Video Output: Clip Output panel, configure the available Clip Channel outputs.

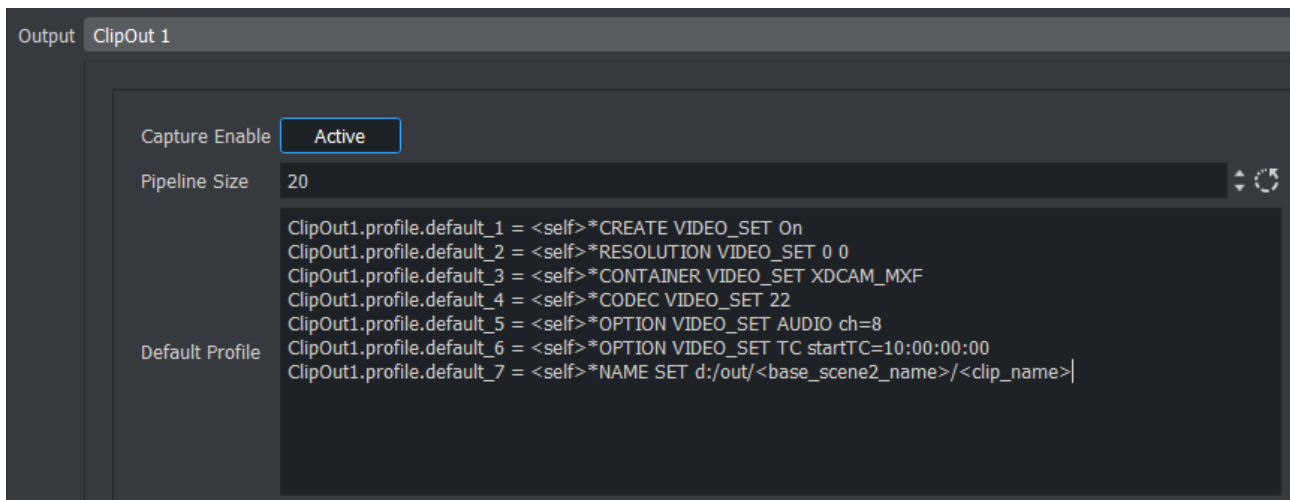

- **Capture Enable:** Enables or disables the clip writer functionality. The main use is to give control over host memory resources. When the clip writer functionality is not needed, the clip out channel does not need to be allocated.
- **Pipeline Size:** Controls the number of frames that the clip writer uses to handle a file. It is recommended to leave the default value.
- **Default Profile:** Contains a default profile that can be loaded on request, with the command

`RENDERER*VIDEO*CLIPOUT*1*PROFILE APPLY` . Example:

```
# the <self> placeholder gets replaced with the proper RENDERER*VIDEO*CLIPOUT*1
ClipOut1.profile.default_1 = <self>*CREATE VIDEO_SET On
ClipOut1.profile.default_2 = <self>*RESOLUTION VIDEO_SET 0 0
ClipOut1.profile.default_3 = <self>*CONTAINER VIDEO_SET XDCAM_MXF
```

```
ClipOut1.profile.default_4 = <self>*CODEC VIDEO_SET 22
ClipOut1.profile.default_5 = <self>*OPTION VIDEO_SET AUDIO ch=8
ClipOut1.profile.default_6 = <self>*OPTION VIDEO_SET TC startTC=10:00:00:00
ClipOut1.profile.default_7 = <self>*NAME SET d:/out/<base_scene2_name>/
<clip_name>
```

### 8.30.2 Clip-out Channel Placeholders

The available placeholders for clip-out channel are:

Variable	Definition
<hostname>	Expands to the host name.
<if0>	Expands to the IPV4 network address of the first network interface.
<if1>	Expands to the IPV4 network address of the second network interface.
<if2>	Expands to the IPV4 network address of the third network interface.
<absolute_scene_name>	Expands to the complete path of the loaded scene.
<absolute_scene2_name>	Expands to the complete path of the loaded scene2.

### 8.30.3 Sample Commands

1080i50 A MPEG-2 Codec / MpegIFrame422ProfileHighLevel\_WithAlpha with a Bitrate of 150 and 16 Channel Audio

```
RENDERER*VIDEO*CLIPOUT*1*CREATE VIDEO_SET ON
RENDERER*VIDEO*CLIPOUT*1*RESOLUTION VIDEO_SET 0 0
RENDERER*VIDEO*CLIPOUT*1*CONTAINER VIDEO_SET AVI
RENDERER*VIDEO*CLIPOUT*1*CODEC VIDEO_SET 36
RENDERER*VIDEO*CLIPOUT*1*OPTION VIDEO_SET AUDIO ch=16 bits=24/32
RENDERER*VIDEO*CLIPOUT*1*OPTION VIDEO_SET IFRAME bitrate=150
RENDERER*VIDEO*CLIPOUT*1*NAME SET "D:
\clipout\1080i50_MPEG-2__MpegIFrame422ProfileHighLevel_WithAlpha[ch=16 bits=24-32]
[bitrate=150]"
```



```

RENDERER*VIDEO*CLIPOUT*1*CONTROL START
...
RENDERER*VIDEO*CLIPOUT*1*CONTROL PAUSE
RENDERER*VIDEO*CLIPOUT*1*CONTROL FLUSH

```

### 1080p50 Video AVC-Intra Encoder / AVCIntraClass50 with Timecode, No Audio

```

RENDERER*VIDEO*CLIPOUT*1*CREATE VIDEO_SET ON
RENDERER*VIDEO*CLIPOUT*1*RESOLUTION VIDEO_SET 0 0
RENDERER*VIDEO*CLIPOUT*1*CONTAINER VIDEO_SET P2_MXF
RENDERER*VIDEO*CLIPOUT*1*CODEC VIDEO_SET 43
RENDERER*VIDEO*CLIPOUT*1*OPTION VIDEO_SET AVCINTRA profile=1
RENDERER*VIDEO*CLIPOUT*1*OPTION VIDEO_SET TC startTC=00:10:00:00
RENDERER*VIDEO*CLIPOUT*1*NAME SET "D:\clipout\1080p50_Video_AVC-
Intra_Encoder_AVCIntraClass50[TimeCode]"
RENDERER*VIDEO*CLIPOUT*1*CONTROL START
...
RENDERER*VIDEO*CLIPOUT*1*CONTROL PAUSE
RENDERER*VIDEO*CLIPOUT*1*CONTROL FLUSH

```

### 720p DVCPRO 100 Codec / D12\_720\_4to3\_422\_Fr1 Four Channel Audio

```

RENDERER*VIDEO*CLIPOUT*1*CREATE VIDEO_SET ON
RENDERER*VIDEO*CLIPOUT*1*RESOLUTION VIDEO_SET 0 0
RENDERER*VIDEO*CLIPOUT*1*CONTAINER VIDEO_SET AVI
RENDERER*VIDEO*CLIPOUT*1*CODEC VIDEO_SET 17
RENDERER*VIDEO*CLIPOUT*1*OPTION VIDEO_SET AUDIO ch=4 bits=24/32
RENDERER*VIDEO*CLIPOUT*1*NAME SET "D:
\clipout\720p60M_DVCPRO_100__D12_720_4to3_422_Fr1[ch=4 bits=24-32]"
...
RENDERER*VIDEO*CLIPOUT*1*CONTROL PAUSE
RENDERER*VIDEO*CLIPOUT*1*CONTROL FLUSH

```

### UHD 2160p XAVC Eight Channel Audio with M264 Encoder

```

RENDERER*VIDEO*CLIPOUT*1*CREATE VIDEO_SET On
RENDERER*VIDEO*CLIPOUT*1*CREATE AUDIO_SET Off
RENDERER*VIDEO*CLIPOUT*1*CREATE KEY_SET Off
RENDERER*VIDEO*CLIPOUT*1*RESOLUTION VIDEO_SET 0 0
RENDERER*VIDEO*CLIPOUT*1*CONTAINER VIDEO_SET XAVC_MXF
RENDERER*VIDEO*CLIPOUT*1*CODEC VIDEO_SET 47
RENDERER*VIDEO*CLIPOUT*1*OPTION VIDEO_SET AUDIO ch=8 bits=24/32
RENDERER*VIDEO*CLIPOUT*1*OPTION VIDEO_SET XAVC profile=HDItra100CBG use_hw=1
RENDERER*VIDEO*CLIPOUT*1*NAME SET "C:\test.mxf"

```

```
RENDERER*VIDEO*CLIPOUT*1*CONTROL RECORD 1000
```

**i Information:** To record in XAVC UHD, the output color depth must be set to 10-bit (*output\_bpc = 10*). Recording in XAVC UHD requires a M264 board. (OPTION VIDEO\_SET XAVC *profile=HDIIntra100CBG use\_hw=1*)

## 8.31 Video Output: SHM Output

Configure Shared Memory Output channels from this panel. The shared memory output is only available on systems with no video boards, or if **Check Video Card** is set to `None` in the [Video Board](#) section.

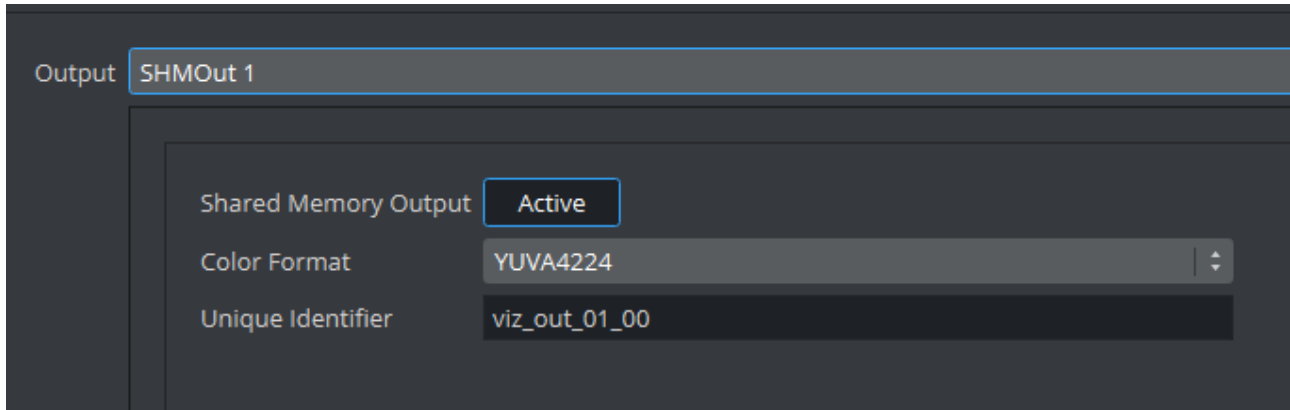

- **Shared Memory Output:** Sets the output mode for Shared Memory. Options are `Active` or `Inactive`.
- **Color Format:** The format the Shared memory texture is using: can be `YUVA4224` or `RGBA`.
- **Unique Identifier:** Changes the name of the Shared Memory if required. Used when connecting to services such as Viz Coder.

## 8.32 Viz License Configuration

The Viz License Configuration allows users to configure their Viz Engine for WIBU Licensing.

License	Count	Expiration
<input checked="" type="checkbox"/> v2 Engine Core	0/300	2023-01-31T13:00:00+0100
<input type="checkbox"/> v2 Artist	0/300	2023-01-31T13:00:00+0100
<input type="checkbox"/> v2 DVI out HD	0/300	2023-01-31T13:00:00+0100
<input type="checkbox"/> v2 NDI input/output single	0/300	2023-01-31T13:00:00+0100
<input type="checkbox"/> v2 MezzIP single	0/300	2023-01-31T13:00:00+0100
<input type="checkbox"/> v2 Frameserver single	0/300	2023-01-31T13:00:00+0100
<input type="checkbox"/> v2 SDI/IP Video Input Enablement (max)	0/300	2023-01-31T13:00:00+0100
<input type="checkbox"/> v2 NDI IN Upgrade (max)	0/300	2023-01-31T13:00:00+0100
<input type="checkbox"/> v2 MezzIP IN Upgrade (max)	0/300	2023-01-31T13:00:00+0100
<input type="checkbox"/> v2 SDI/IP OUT Channel	0/300	2023-01-31T13:00:00+0100
<input type="checkbox"/> v2 NDI OUT Channel	0/300	2023-01-31T13:00:00+0100
<input type="checkbox"/> v2 MezzIP OUT Upgrade (max)	0/300	2023-01-31T13:00:00+0100
<input type="checkbox"/> v2 4K Video Enablement	0/300	2023-01-31T13:00:00+0100
<input type="checkbox"/> v2 DVI OUT Max Resolution	0/300	2023-01-31T13:00:00+0100
<input type="checkbox"/> v2 Multiple Frameservers (max)	0/300	2023-01-31T13:00:00+0100
<input type="checkbox"/> v2 Chroma FX	0/300	2023-01-31T13:00:00+0100
<input type="checkbox"/> v2 Global Illumination FX	0/300	2023-01-31T13:00:00+0100
<input type="checkbox"/> v2 Vizrt Multi-touch Plugin Package	0/300	2023-01-31T13:00:00+0100
<input type="checkbox"/> v2 Bone&Skin Live Motion Capture	0/300	2023-01-31T13:00:00+0100
<input type="checkbox"/> v2 Cinema 4D Import	0/300	2023-01-31T13:00:00+0100
<input type="checkbox"/> v2 Dolby E Decoder License	0/300	2023-01-31T13:00:00+0100
<input type="checkbox"/> v2 Dolby E Encoder License	0/300	2023-01-31T13:00:00+0100
<input type="checkbox"/> v2 Viz Engine DNxHD Codec Support	0/300	2023-01-31T13:00:00+0100
<input type="checkbox"/> v2 RTT Shaders FX	0/300	2023-01-31T13:00:00+0100
<input type="checkbox"/> v2 Substance FX Authoring	0/300	2023-01-31T13:00:00+0100
<input type="checkbox"/> v2 ezGallery	0/300	2023-01-31T13:00:00+0100
<input type="checkbox"/> v2 ezPostFx	0/300	2023-01-31T13:00:00+0100
<input type="checkbox"/> v2 ezShaders	0/300	2023-01-31T13:00:00+0100
<input type="checkbox"/> v2 ezMesh	0/300	2023-01-31T13:00:00+0100
<input type="checkbox"/> v2 ezDeform	0/300	2023-01-31T13:00:00+0100
<input type="checkbox"/> v2 ezComposer	0/300	2023-01-31T13:00:00+0100
<input type="checkbox"/> v2 ezLogic	0/300	2023-01-31T13:00:00+0100
<input type="checkbox"/> v2 ezLink	0/300	2023-01-31T13:00:00+0100
<input type="checkbox"/> v2 ezTubular	0/300	2023-01-31T13:00:00+0100
<input type="checkbox"/> v2 DornaMT APP	0/300	2023-01-31T13:00:00+0100
<input type="checkbox"/> v2 DornaMT Plugin	0/300	2023-01-31T13:00:00+0100

Engine Features
<input checked="" type="checkbox"/> enable Engine Core
<input checked="" type="checkbox"/> Disable Watermark Overlay
<input type="checkbox"/> Disable Watermark Overlay PAL/SD max.
<input type="checkbox"/> enable UI Communication Port
<input type="checkbox"/> number of SDI Inputs
<input type="checkbox"/> number of NDI Inputs
<input type="checkbox"/> number of Mezzanine IP Inputs
<input type="checkbox"/> enable SDI Output
<input type="checkbox"/> enable NDI Output
<input type="checkbox"/> enable Mezzanine IP Output
<input type="checkbox"/> enable 2k-4k Resolution
<input type="checkbox"/> enable DVI Output 2k max.
<input type="checkbox"/> enable DVI Output All Resolutions
<input type="checkbox"/> enable Multiplexer Port
<input type="checkbox"/> enable Chroma FX
<input type="checkbox"/> enable Global Illumination
<input type="checkbox"/> enable Multitouch
<input type="checkbox"/> enable Motion Capture Data Reader
<input checked="" type="checkbox"/> enable Audio
<input checked="" type="checkbox"/> enable DVE
<input checked="" type="checkbox"/> enable After Effects Import
<input checked="" type="checkbox"/> enable Image FX
<input checked="" type="checkbox"/> enable Real FX
<input checked="" type="checkbox"/> enable Spline FX
<input checked="" type="checkbox"/> enable Text FX
<input checked="" type="checkbox"/> enable Pixel FX
<input checked="" type="checkbox"/> enable Graffiti FX
<input checked="" type="checkbox"/> enable Weather FX
<input checked="" type="checkbox"/> enable Social TV FX
<input checked="" type="checkbox"/> enable EVS Control
<input checked="" type="checkbox"/> enable Geo FX
<input type="checkbox"/> enable Cinema4D Import
<input type="checkbox"/> enable Dolby E Decoder
<input type="checkbox"/> enable Dolby E Encoder
<input type="checkbox"/> enable DNxHD Codec
<input type="checkbox"/> enable RTT Shaders

The container specifies the location the system searches for a WIBU license. These are all available containers provided by the Codemeter Runtime. If a license server is not listed here, be sure to check the Server Search List in your Codemeter Runtime Configuration.

**Information:** Retrieving the license information from your network sources requires some time and currently blocks the dialog.

The license configuration is split into two columns:

The left column allows you to specify which licenses you want to acquire from your selected container.

- **Core License** selects the Core a user must acquire to start Viz Engine. The can be either:
  - Engine Core
  - Preview Core
  - Artist Free
  - Viz Libero Core
  - Viz Arena Camera Tracking Engine

- Viz Eclipse Core

Additional Licenses can be enabled by setting the checkmark next to it.

The right column shows which Viz Engine application features are enabled by your selected licenses. Several features are automatically enabled when you select a core license. To check which features are enabled or disabled by which license, hover over the feature to get a description.

For additional details related to each license, see [WIBU Licensing System](#) in the Viz Engine Administrator manual.



**Important:** Any change in the license configuration requires a restart of Viz Engine.

---

## 8.33 Viz One

To enable data exchange between Viz One and Viz Engine, two services are required:

- A Viz One File System Monitor (Fsmon) Service (monitors files which are located in the Clip Data directory location ( `--root=d: /` )).
- A File Transfer (Mediaftp) Service (transfers files to the Viz Engine).

**Info:** Both **Mediaftp** and **Fsmon** have individual *.msi* installers rather than being included in the VizEngine *.msi* starting with Viz Engine version 4.0. They are included in the Viz Artist Bundle installer.

**IMPORTANT!** If the location of the Clip Data directory is changed after installation, remove and install the two services again. They automatically set to the new Clip Data Directory (see [Local Settings](#) ).

To search, view and select video clips from Viz One, configure the [Viz One Browser](#).

**Note:** Viz Artist features a *Viz One Transfer Status* pane that shows the progress of any active and finished clip transfers from Viz One. This pane requires the MediaFTP (File Transfer) and Fsmon (File System Monitor) services to be installed and running, and the correct configuration of the Viz One MessageQueue Server.

To use Viz One with Viz Artist, each Viz Artist/Viz One integration must be authenticated through the [Authentication](#) panel in the Viz Configuration. See [Integration with Viz One](#) for the Fsmon and Mediaftp install and remove procedures.

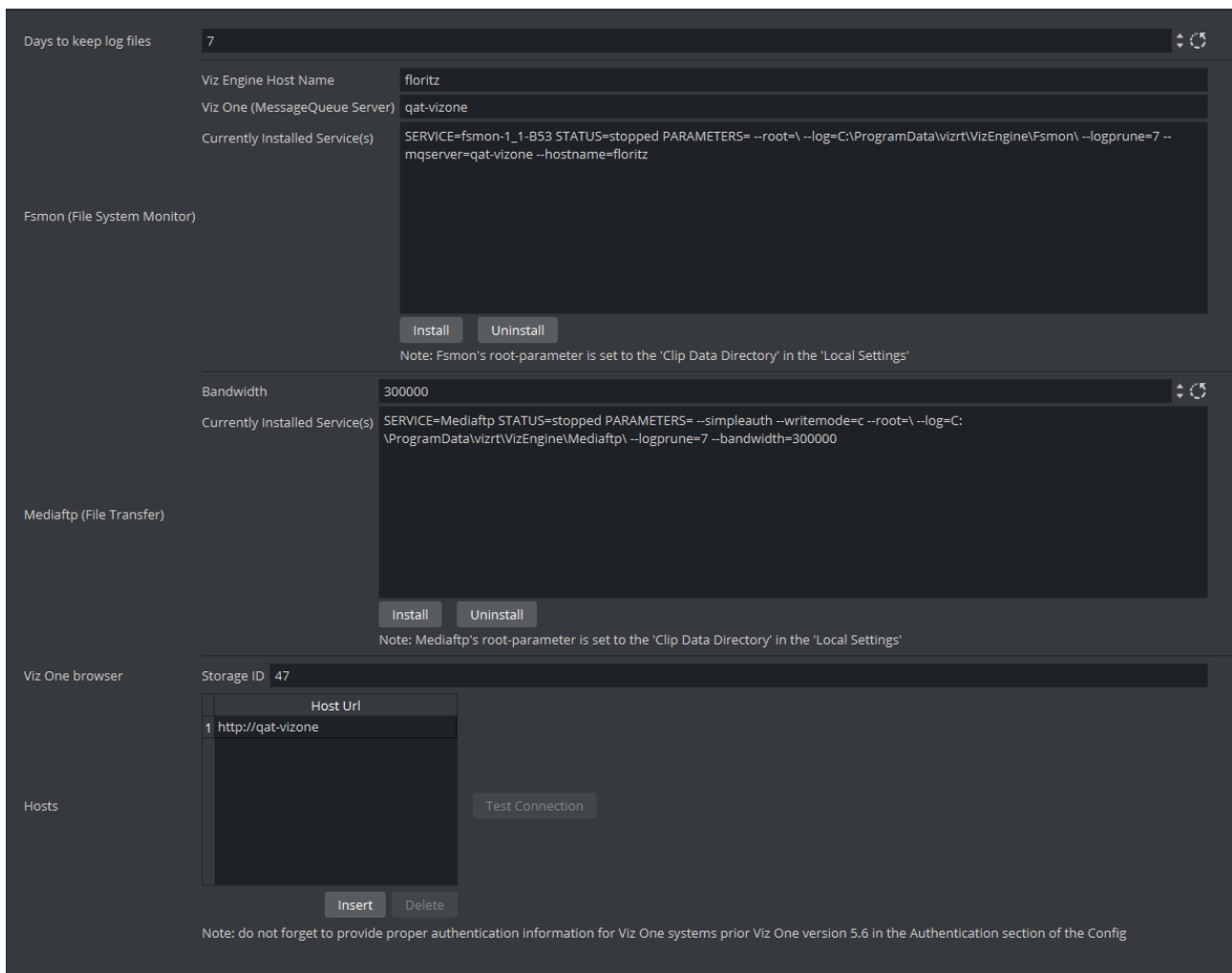

### 8.33.1 Viz One Properties

This section details the properties of the Viz One configuration panel.

- **Days to keep log files:** Sets the number of days to keep log files (default is seven days). Log files older than the set number of days are deleted.

#### Fsmon (File System Monitor)

- **Viz Engine Host Name:** Sets the name of the local host (local host name entered by default). Make sure that the host name is exactly the same as the string specified in the Viz One Server Configuration
- **Viz One (MessageQueue Server):** Sets the host name of the active Message Queue server (do not use a protocol prefix, for example, <http://>)

**✘ IMPORTANT!** To view and transfer files in Viz Artist, the host name entered in the **Viz One (MessageQueue Server)** must also be entered in the **Viz One Browser** panel.

- **Currently Installed Service(s):** Shows the currently installed Fsmom service, with its parameters.
- **Install/Uninstall:** Installs and removes Fsmom service.

**Note:** Any currently installed service must be removed before a new service can be installed.

## Mediaftp (File Transfer)

- **Band Width:** Sets the transfer bandwidth, in Kbits per second.
- **Currently Installed Service(s):** Shows the currently installed Mediaftp service with its parameters.
- **Install/Uninstall:** Installs and removes Mediaftp service.

**Note:** Any currently installed service must be removed before a new service can be installed.

## Viz One Browser

This is the configuration for the Viz One Browser in the Media Asset tab (see the Media Asset section of the [Viz Artist User Guide](#)).

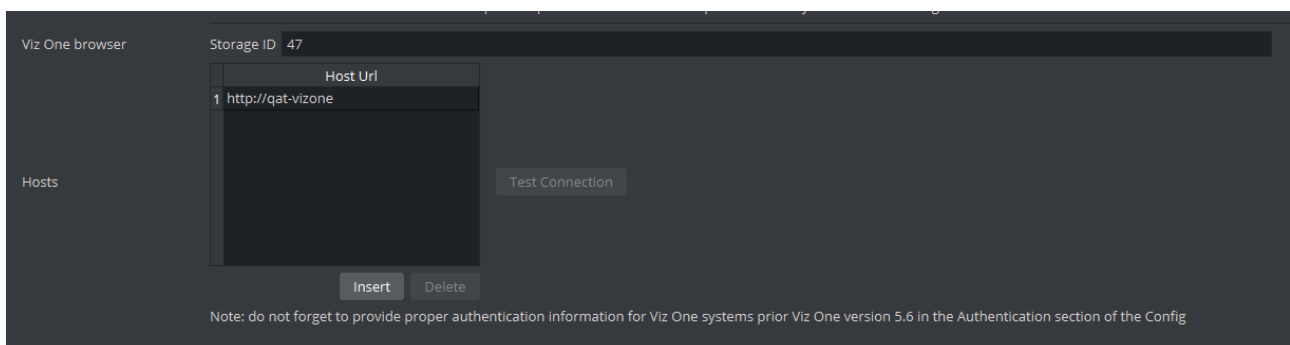

- **Storage ID:** Displays the Storage ID for Viz Artist as configured in Viz One.
- **Hosts:** Opens a dialog to provide Viz Engine with the host-name for the desired Viz One instance when the **Add** button is clicked. The host name must include the protocol prefix, for example: `http://vme57-sia`. To remove a previously configured Viz One instance, select it from the list of hosts and click the **Delete** button.
- **Test Connection:** Selects the desired host and click the **Test Connection** button to check if the configured Viz One connection is working correctly.
  - If Test Connection returns that the Viz Engine is not registered as a Video Server, the Engine must be added as a server in the Viz One Studio Administration. Please refer to the Viz One documentation for further information.



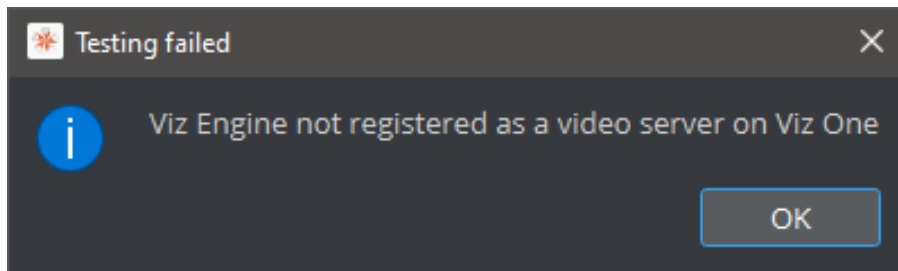

- If Test Connection returns a Storage ID mismatch, please adjust the **Storage ID** field accordingly.

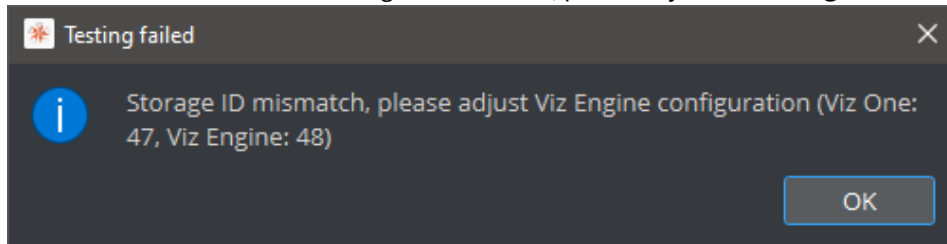

- If Test Connection returns that the connection is valid, the Viz One instance has been configured correctly and is ready for use with Viz Engine.

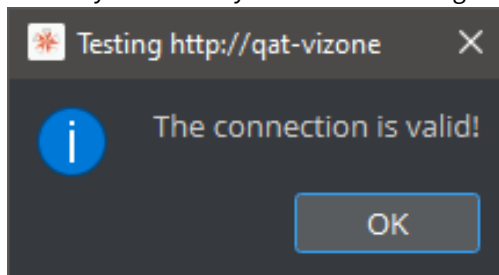

## 9 On Air Mode

The On Air interface may vary, depending on the software and hardware configuration used. In Viz Artist, designers can click the On Air button on the main menu to switch Viz Artist from a modeling tool to a render engine. The application then waits for control commands; however, scene animations can also be rendered by the use of the [Control Buttons](#) (top-left corner).

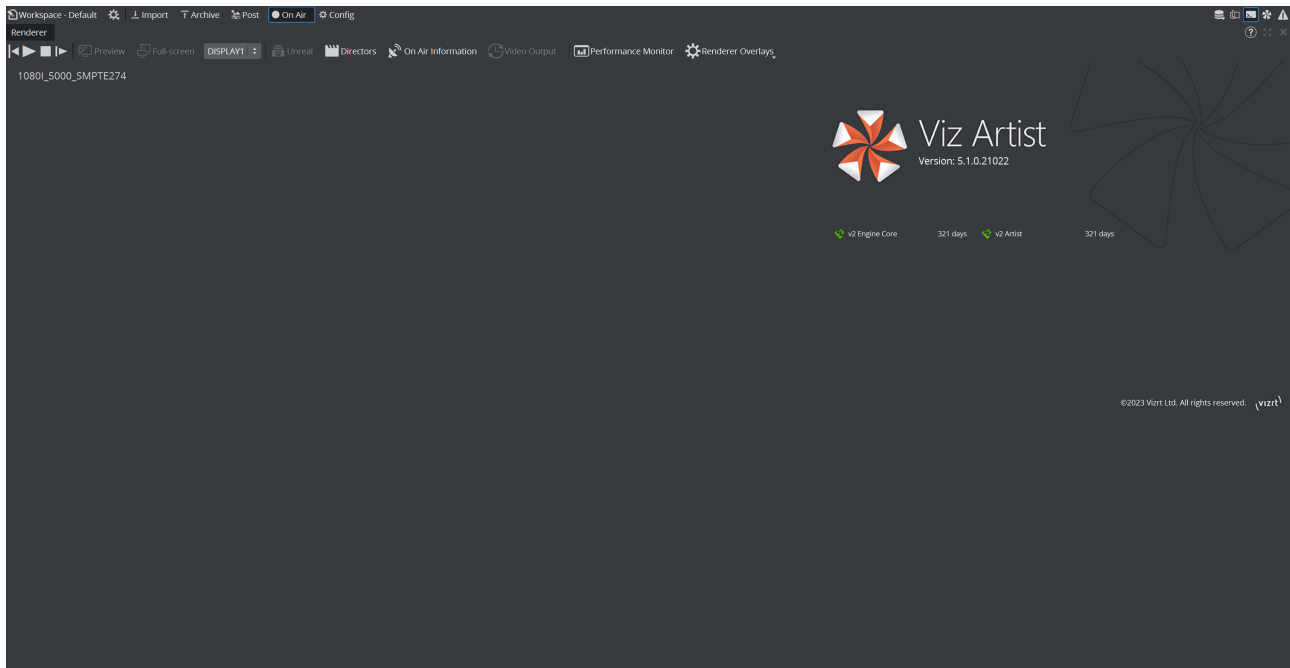

The top left of the On Air screen shows a set of [Control Buttons](#), as well as a [Performance](#) bar button. Depending on the software and hardware settings, additional buttons and information are available.

This section contains information on the following topics:

- [Director Control Pane](#)
- [Control Buttons](#)
- [Performance](#)
- [On Air Information Panel](#)
- [License Information](#)

## 9.1 Director Control Pane

When in On Air mode, the clapper board button opens the Director Control Panel window.

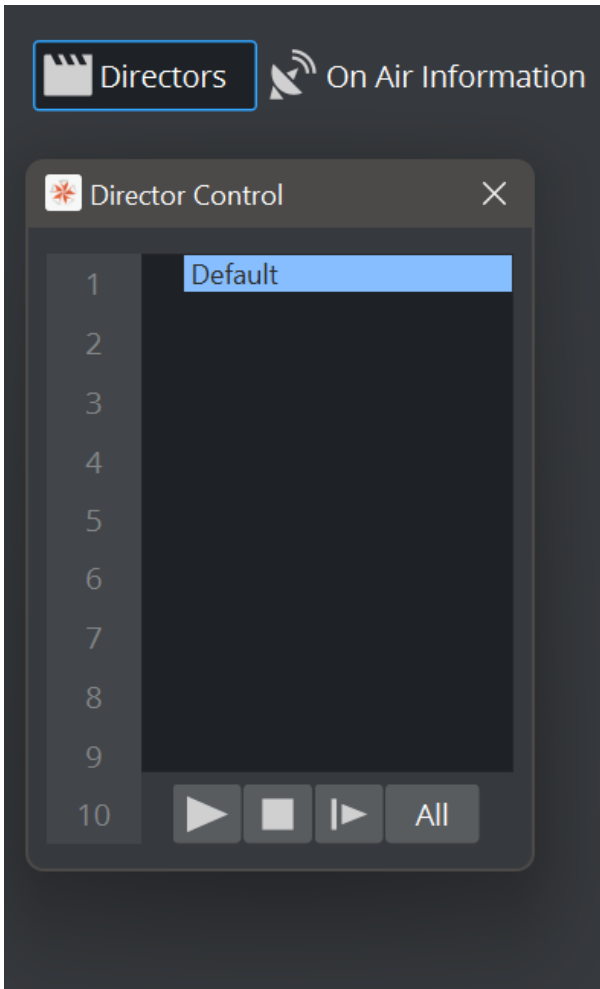

The Director Control Panel window can be used to select and animate one, multiple or all directors in the front, main or back layer. In addition, it can be used to set slots and to animate a combination of director(s).

See the **Director Control Panel** page in **The Stage for Animation** section of the [Viz Artist User Guide](#) for a detailed description of the Director Control Panel.

## 9.2 Control Buttons

This section contains information on the Controls Buttons, which include the Play and the On Air buttons.

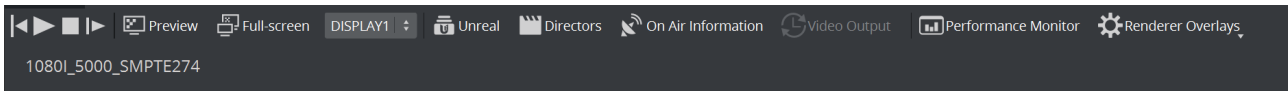

- **Back:** Jumps to the beginning of the animation in the scene.
- **Play:** Starts the animation of the scene.
- **Stop:** Stops the animation of the scene.
- **Continue:** Continues the animation after it stopped at a stop point.
- **Render Preview:** Shows or hides the VGA Preview window. The keyboard shortcut for activating or deactivating this window is **SHIFT + BACKSPACE**.

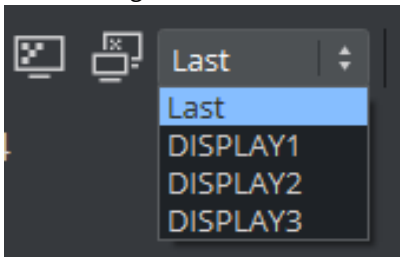



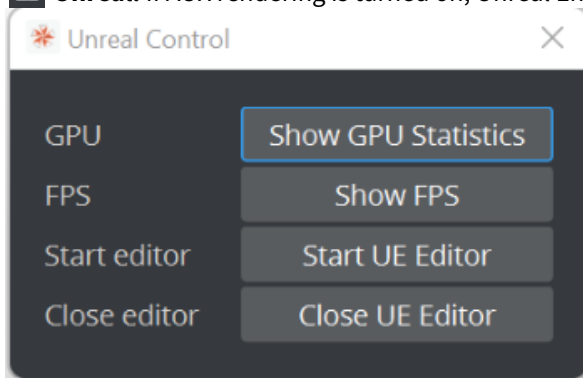

The state of the VGA Preview window depends on how the **Render preview default setting** in the **Video Output** section of Viz Config is configured:

- **Inactive:** Does not display by default.
- **Active:** Displays by default.
- **Fullscreen:** Sets the On Air window to screen size.
- **Unreal:** If AUX rendering is turned on, Unreal Engine Control can be enabled:

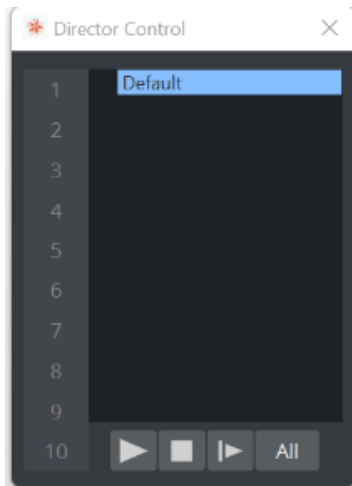

- **Directors:** Shows or hides the [Director Control Pane](#) window.



-  **On Air Information:** Shows or hides the [On Air Information Panel](#) window.
-  **Video Output:** Shows the video sync settings.
-  **Performance Monitor:** Shows or hides the [Performance Bar](#).
-  **Renderer Overlays:** Allows to enable on of the following overlays:
  - Performance Bar
  - Camera Stats
  - Center Shift Monitor
  - Audio Levels

## 9.3 Performance

Analyzing the performance of Viz Artist/ Viz Engine can be done with two tools:

- **Performance Monitor:** Closely monitors a range of parameters for analyzing real-time performance.
- **Performance Analyzer:** Monitors key performance and camera parameters, as a head-up display in the renderer window.

### 9.3.1 Performance Monitor

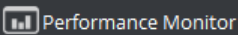
To open the Performance monitor click on the  toolbar button.

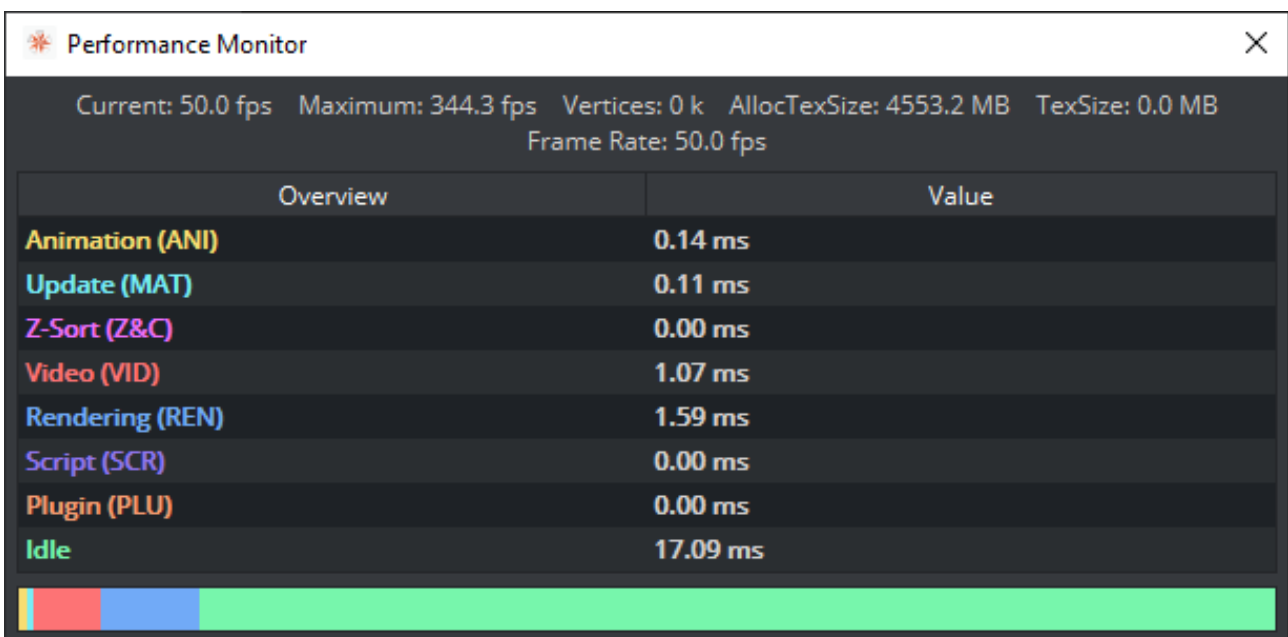

The performance bar gives an idea of the current scene rendering performance (frames per second).

- **Current (CUR):** Shows how many frames per second the scene renders in On Air mode. The number should be above 50 (PAL) or 60 (NTSC), according to the rate that has been specified in the **Output Format** section of the [Viz Engine Administrator Guide](#).
- **Maximum (MAX):** Shows how many frames per second the scene can render at without waiting for vertical retrace. The higher the maximum value, the more performance is left. If the maximum value is reduced to below 50 or 60, the scene is not rendering in real-time.
- **Vertices (VER):** Shows the number of vectors in the scene.
- **AllocTexSize (TET):** Shows the total allocated size of texture memory.
- **TexSize (TEC):** Shows the size of the currently used texture memory.
- **Animation (ANI):** Shows how many microseconds all active directors and animation channels take. This indicator is linked to the yellow bar.
- **Update (MAT):** Transforms each container in the scene into world coordinate space. This indicator is linked to the cyan bar.

- **Z-Sort (Z&C):** Refers to Z-sort and Culling, and sorts all containers for correct transparency drawing and determines if containers are visible in the current camera view. This indicator is linked to the pink bar.
- **Video (VID):** Shows how many microseconds video input (live video texture) and video output take. De-interlaced video inputs take longer time than progressive and interlaced. The only way to improve this value is to use a faster system. This indicator is linked to the red bar.
- **Rendering (REN):** Shows how many microseconds it takes to render all objects on the screen. A faster graphics card improves this value. This indicator is linked to the blue bar.
- **Script (SCR):** Shows the consumed time in microseconds from all active scripts. This indicator is linked to the dark green bar.
- **Plugin (PLU):** Indicates how much time in microseconds all active plug-ins spend in each render cycle. This indicator is linked to the orange bar.
- **Idle:** Shows available resources in microseconds the renderer has available. This indicator is linked to the light green bar.

### 9.3.2 Renderer Overlays

To select which performance data to show in the renderer window, click on the **Render Overlays** tool button then select the options to show:

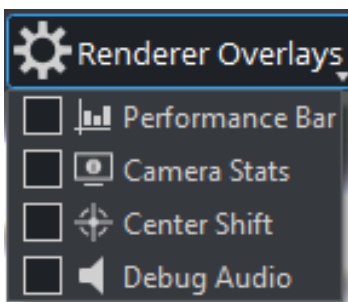

- **Performance Bar:** Shows the a detailed Performance analyzer.
- **Camera Stats:** Enables the head-up display (HUD) showing the following parameters in the renderer view:
  - **Camera 1-n:** Shows the currently selected camera.
  - **Position:** Shows the camera's X, Y and Z position.
  - **Pan/Tilt/Twist:** Shows the camera's pan, tilt and twist parameters.
  - **FovX/FovY:** Shows the camera's field of view (FOV) for the horizontal (X) and vertical (Y) plane.
  - **Center Shift:** Shows the X and Y position of the camera's center shift.
- **Center Shift:** Shows the center shift marker as a cross hair in the renderer.
- **Debug Audio:** Turns on/off a visual representation of the audio mixing.

#### Performance Bar (Classic)



The performance bar gives an idea of the current scene rendering performance (frames per second).

The values shown are the same as described in the [Performance Monitor](#) section above.

## Performance Bar and Analyzer (Viz Engine Render Pipeline)

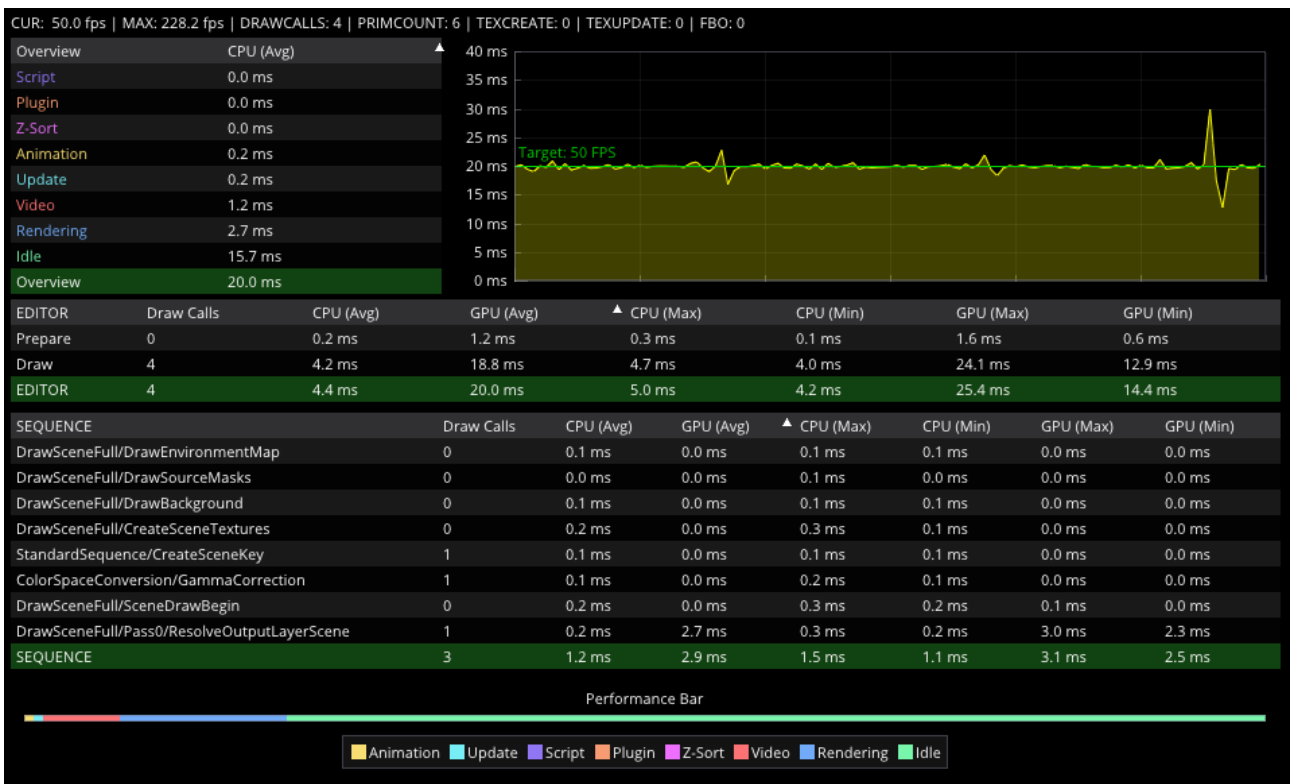

The Viz Engine Render Pipeline shows more detailed information about:

- Current and Maximum Framerate.
- Segmented render time and historic data.
- Timing information for all used Sequence pipelines.
- Performance Bar.



## 9.4 On Air Information Panel

The On Air Information panel shows the required parameters to send external control commands and all connected clients, with the IP address, host name and Viz Port.

**Note:** Polling for On Air information can decrease the performance. For information on how to adjust the On Air Update Interval, see the [User Interface](#) page of Viz Configuration.

### 9.4.1 Basic Tab

In the Basic tab, the parameters required to send external control commands are shown:

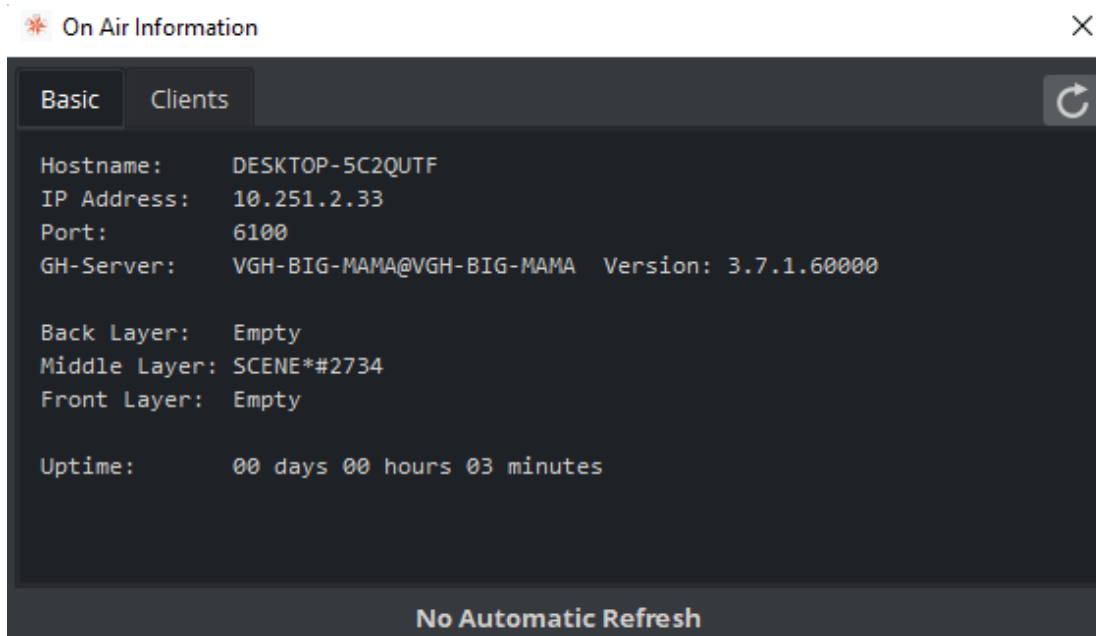

- **Refresh button:** Refreshes the status information.
- **Hostname:** Shows the name external control programs can use to communicate with Viz Artist.
- **IP Address:** Shows the IP address external control commands can communicate with Viz Artist.
- **Port:** Shows the port Viz Artist is using. Default port is `6100`, but may be changed in the **Communication** section of Viz Configuration.
- **GH-Server:** Shows the Graphic Hub Manager server Viz Artist is connected to.
- **Back Layer:** Shows the name of the scene that is defined to run in the background of the middle and front layer scene(s).
- **Middle Layer:** Shows the name of the scene that is defined to run in the middle between the back and front layer scene(s).
- **Front Layer:** Shows the name of the scene that is defined to run in the foreground of the back and middle layer scene(s).
- **Uptime:** Shows the time elapsed since Viz was started.

## 9.4.2 Clients Tab

In the Clients tab, all connected clients are shown with the IP address, host name and Viz Port.

✱ On Air Information ✕

BasicClients↻

IP-Address	Host-Name ▲	Port	Viz-Port

External: 0   Isolated: 0   Shared: 0   SharedFixed: 0   Preview: 0

**No Automatic Refresh**

## 9.5 License Information



The license information listing shows licensed features and how many days a given license has left before it must be renewed.

---

## 10 Video IO Configuration And Features

These chapters list some common Video IO related configurations which mainly apply to Matrox boards unless stated differently.

This section contains information on the following topics:

- [Basic IO Configuration](#)
- [High Dynamic Range](#)
- [Mixed Mode Video Support](#)
- [Frame Accurate Output](#)
- [Shared Usage of Input Channels](#)
- [Dynamic Channel Allocation](#)
- [Matrox Supported Codecs](#)
- [DVE Performance](#)
- [Watchdog](#)
- [NDI Output from GFX Channel](#)
- [Clip Player Pro Features](#)

---

## 10.1 Basic IO Configuration

A new way to configure and map your input sources to Viz Engine Live Sources, allowing proper migration from existing workflows to new standards like 2110 or NDI.

### 10.1.1 General Information

The section for enabling/disabling inputs was removed completely, and all other Video Input sections have been concentrated in the two sections for Clip Input and Live Input. Configuration for Output can still be found in the Matrox section.

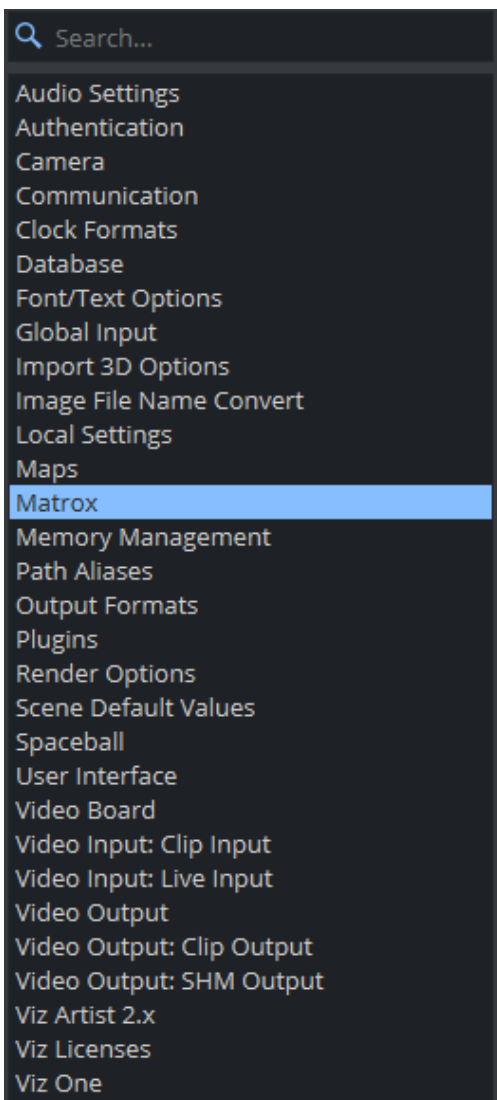

## 10.1.2 Clip Input Channels

The only change for configuring the Clip Input channels is the location to enable single channels, which can be done now directly in the [Video Input: Clip Input](#) section of Viz Config. The Video System can either be set to the desired resolution family or to the new system *Auto*, which configures the system equivalent to the selected Output Format. Explicit selection of anything other than *Auto* is only necessary in mixed setups (for example, 1080p clip channel in a 1080i environment) or for video wall and full screen setups, where the resolution doesn't match standard broadcast formats.

**Information:** The fallback resolution is 1080i.

Channel	Video System
Clip Channel 1	HD - 1080i
Clip Channel 2	Inactive
Clip Channel 3	Inactive
Clip Channel 4	Inactive
Clip Channel 5	Inactive
Clip Channel 6	Inactive
Clip Channel 7	Inactive
Clip Channel 8	Inactive
Clip Channel 9	Inactive
Clip Channel 10	Inactive
Clip Channel 11	Inactive
Clip Channel 12	Inactive
Clip Channel 13	Inactive
Clip Channel 14	Inactive
Clip Channel 15	Inactive
Clip Channel 16	Inactive

Matrox Settings for Clip Input Channel

Pipeline Size	20
Texturemanager Size	3
Video Delay DVE	1
Video Delay Texture	1
VBI	Inactive
Delay DVE	0
Delay Texture	1
Audio	Active
Delay DVE	0
Delay Texture	1
Contains Alpha	Inactive
Upscale Luma	Inactive
Shaped	Inactive
Repeat Mode	Frame
Loop Mode	Active
Reverse Fields	Inactive
Pending	Active
Mode on Load Error	None
Proxy	Active
Reactivation Delay	6
Ringbuffer	Inactive

## 10.1.3 Live Input Channels

This section now includes all inputs (except clip channels) and allows a mix of different resources, like SDI or IP inputs, and various streaming and shared memory sources. With the correct mapping, it is possible to use the same scene containing Live Inputs on both SDI and IP systems, without the need to adapt the scene for IP (previously StreamIn) input channels.

Just like Clip Input Channels, the Live Input Channels can be set to use the Video System *Auto*. This configures the input resolution based on the Output System. Explicit selection of a resolution is only necessary for video wall or full screen setups, if the resolution doesn't match any broadcast standard.

**Information:** The fallback resolution is 1080i.

*Map To VizChannel* was replaced by the setting *Source Connector*. For SDI and IP channel types the physical connector, which should be used as input on the video board, needs to be selected.

Channel	Type
Live Channel 1	IP
Live Channel 2	IP
Live Channel 3	IP
Live Channel 4	IP
Live Channel 5	IP
Live Channel 6	IP
Live Channel 7	Inactive
Live Channel 8	Inactive
Live Channel 9	Inactive
Live Channel 10	Inactive
Live Channel 11	Inactive
Live Channel 12	Inactive
Live Channel 13	Inactive
Live Channel 14	Inactive
Live Channel 15	Inactive
Live Channel 16	Inactive
Live Channel 17	Inactive
Live Channel 18	Inactive
Live Channel 19	Inactive
Live Channel 20	Inactive
Live Channel 21	Inactive
Live Channel 22	Inactive
Live Channel 23	Inactive
Live Channel 24	Inactive

Video System	Auto
Colorimetry	ITUR_BT_709
<b>Video Settings</b>	
Contains Alpha	<input type="checkbox"/>
Delay DVE	1
Delay Texture	3
<b>Audio Settings</b>	
Enable Audio	<input checked="" type="checkbox"/>
Audio Channels	2 Channels
Delay DVE	4
Delay Texture	4
<b>Vbi Settings</b>	
Enable VBI	<input type="checkbox"/>
Delay DVE	4
Delay Texture	4
Source Connector	IP video IN 1
<b>Connector Settings</b>	
3G Level B	<input type="checkbox"/>
Allow Super Black	<input checked="" type="checkbox"/>
Allow Super White	<input checked="" type="checkbox"/>
Chroma Clipping	<input type="checkbox"/>

---

## 10.2 High Dynamic Range

High Dynamic Range (HDR), often in combination with wide color gamut (WCG), is a way to improve the colors shown on screens.

**Info:** HDR support is implemented on 1080p or higher resolutions only. For hardware limitations check the corresponding section below.

### 10.2.1 Introduction

There are several implementations and standards that define High Dynamic Range video as input, output or a combination with rendered content. The following is a short overview of the most common standards:

SDR	HDR
<a href="#">ITU-R BT.601</a>	<a href="#">ITU-R_BT.2100 PQ</a>
<a href="#">ITU-R BT.709</a>	<a href="#">ITU-R_BT.2100 HLG</a>
<a href="#">ITU-R_BT.2020</a>	<a href="#">ITU-R_BT.2100 SLOG3</a>

#### BT.2020

BT.2020 is a color space with a WCG. It covers a larger subset of visible colors than, for example, BT.709. Currently, all HDR settings in Viz Engine use the BT.2020 color space with ten bits per component (bpc) color depth.



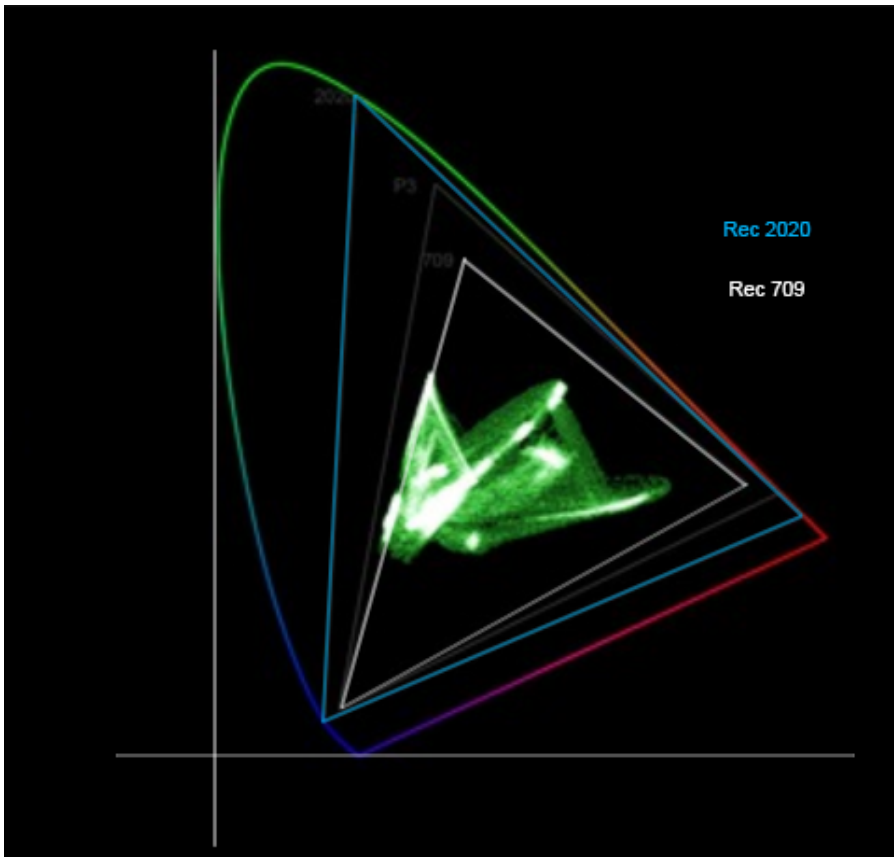

### PQ (Perceptual Quantization)

PQ is standardized as SMPTE ST 2084. PQ defines the luminance levels up to 10,000 cd/m<sup>2</sup> (nit).

### HLG (Hybrid Log-Gamma)

HLG provides a relative value tied to the gamma and logarithmic curve. This system supports practical luminance levels from 1,000 up to 2,000 cd/m<sup>2</sup>. HLG is compatible with conventional SDR systems, which means that TVs that do not support HDR are able to reproduce HDR.

### S-LOG3

S-Log is a gamma curve with a wide dynamic range optimized under the assumption that grading is performed in the post-production process. S-Log3 provides better reproduction of gradation characteristics in shadows and in the mid-tone range than previous S-Log versions; it has characteristics closer to those of scanned film.

## 10.2.2 HDR Support in Viz Engine with Matrox Boards

Viz Engine supports the following use cases:

- DVE pass-through of HDR signals in SDI and ST 2110 (since 3.12 or higher).

- Pass-through of HLG (since 3.12 or higher) and S-Log3 (since 5.3 or higher) texture inputs as scene background.
- SDR overlay on HLG (since 3.12 or higher) or S-Log3 (since 5.3 or higher) content.

## Requirements

- Matrox X.mio3 or newer video board.
- 1080p or UHD resolution.
- P6000 or higher GPU.
- Super-Black and Super-White settings need to be set accordingly.

## Limitations

- Expect higher delays when using HDR in UHD environments due to increased processing requirements; in that case, the ring buffer needs to be enabled but can be set lower than the default value of 5 (for example, =1).
- Rendering for HDR requires much more GPU power than SDR does.
- Only live (SDI & ST 2110) and clip inputs are currently supported.
- No conversions between different frame rates or resolutions are currently supported when HDR is used. Clip input channels can only play clips that have the same resolution.
- Ringing Filter is not available in HDR.
- The number of available DVE layers is lower when using 10-bit inputs.

**Note:** Due to hardware limitations X.mio3 does not support HDR with 2160p resolutions. For UHD/HDR resolutions and higher, an X.mio5 is required.

## 10.2.3 How to Configure HDR

Most of the settings required for HDR are not yet exposed in the GUI. These settings must be changed in the Viz Engine config file.

- Set the output format to 1080p or UHD.
- Set the colorimetry of the output: `output_colorimetry = ITUR_BT_2100_HLG` or `output_colorimetry = ITUR_BT_2100_SLOG3`.
- Set the bits per component of the output: `output_bpc = 10`.
- Set the renderer to use 16 bits per channel : `bits_per_channel = 16`.
- Set the color space conversion to shader: `rgb_2_yuv = 1`.

## For Inputs

- Set the input to the same resolution, frame rate and colorimetry as the output.
- Set input bits per component to 10 if required. Example: `clip_bpc1 = 10`.

## For SDR Overlays

- Enable **Color LUT** in configuration **Render Options**.
- Select the conversion to use. You can use a built-in conversion for HLG or use a custom conversion by providing a LUT as a cube file.
  - Select **Display-referred direct mapping of SDR to HLG** to use the built-in LUT
  - or provide a file path in the config file: `color_lut_filepath = C:\path\to\file.cube` .

If a LUT file path is set in the configuration file, that LUT is used instead of the build-in one.

## SDR Overlay in HDR Environment

To maintain the appearance of SDR signals in an HDR environment, the signals must be converted. This is useful for rendering existing overlays on HDR content. Viz Engine currently supports this conversion in HLG environments. The recommended scene design is an input as scene background or DVE with an SDR overlay. Depending on the render sequence, the conversion is applied to keyed elements of a scene. The conversion is not applied on additional GFX Channel DVE layers.

## Additional Information for S-Log3

A proper LUT needs to be provided when using S-Log3 HDR.

**Note:** As the Sony documentation is somewhat unclear whether any given value encoded in the LUT is meant to be used in narrow (64 to 940) or full range (0 to 1023) scaling, it is dependent on the used LUT. To compensate, use the configuration setting `color_lut_scale_to_full_range = 1` if necessary.

## 10.2.4 HDR Support in Viz Engine with NDI

Viz Engine 5.3 supports pass-through of HLG texture inputs as scene background and SDR overlays with NDI.

**Note:** HDR with NDI requires software I/O mode NDI and does not work with Classic scenes

## 10.2.5 How to Configure HDR with NDI

Most of the settings required for HDR are not yet exposed in the GUI. These settings must be changed in the Viz Engine config file.

- Select software I/O mode NDI in section Video Board.
- Output:
  - Set the output format to 1080p or UHD.
  - Set the colorimetry of the output to HLG: `output_colorimetry = ITUR_BT_2100_HLG` .
  - Set the renderer to use 16 bits per channel: `bits_per_channel = 16` .
- Input:
  - Set Type to NDI.
  - Set Bits Per Channel to 16.

 **Note:** NDI input streams are only treated as HLG if the streams metadata is set accordingly by the sender.

## SDR Overlay in HDR Environment

The scene design rules for HDR in SDI environments also apply to NDI environments, with two notable differences:

1. Hardware DVE is not available.
2. S-Log3 is not supported.

## 10.3 Mixed Mode Video Support

This section gives an overview of the Matrox mixed mode video support. The tables are valid for both genlock families in Viz Engine. One is 25/50 (for example, PAL/720p50/1080i25/1080i50) and the other is 30M/60M (for example, NTSC/720p60M/1080i30M/1080i60M).

The genlock family refers to the used house signal (for example, black burst) frequency, typically PAL for the first and NTSC for the latter. Please observe that genlock families can not be mixed.

The following contain information on the following topics:

- [Source: PAL or NTSC](#)
  - [Video In to DVE and Texture](#)
  - [Clip In to DVE and Texture](#)
- [Source: 720p](#)
  - [Video In to DVE and Texture](#)
  - [Clip In to DVE and Texture](#)
- [Source: 1080i](#)
  - [Video In to DVE and Texture](#)
  - [Clip In to DVE and Texture](#)

### 10.3.1 Source: PAL or NTSC

The first two tables show video in to DVE and texture output capabilities, while the next two tables show clip in to DVE and texture output capabilities. Please observe that genlock families can not be mixed.

#### Video In to DVE and Texture

Output DVE	Video In		
	PAL/NTSC	720p	1080i
PAL/NTSC	OK	-	-
720p	-	-	-
1080i	OK	-	-
Output Texture	Video In		
	PAL/NTSC	720p	1080i
PAL/NTSC	OK	-	-
720p	OK	-	-

Output Texture	Video In		
1080i	OK	-	-

## Clip In to DVE and Texture

Output DVE	Clip In		
	PAL/NTSC	720p	1080i
PAL/NTSC	OK	-	-
720p	-	OK	-
1080i	OK	OK	-

Output Texture	Clip In		
	PAL/NTSC	720p	1080i
PAL/NTSC	OK	-	-
720p	OK	OK	-
1080i	OK	OK	OK

## 10.3.2 Source: 720p

The first two tables show video in to DVE and texture output capabilities, while the next two tables show clip in to DVE and texture output capabilities. Please observe that genlock families can not be mixed.

## Video In to DVE and Texture

Output DVE	Video In		
	PAL/NTSC	720p	1080i
PAL/NTSC	-	-	-
720p	-	-	OK
1080i	-	-	OK

Output Texture	Video In		
	PAL/NTSC	720p	1080i
PAL/NTSC	-	OK	-
720p	-	OK	-
1080i	-	OK	-

## Clip In to DVE and Texture

Output DVE	Clip In		
	PAL/NTSC	720p	1080i
PAL/NTSC	OK	-	-
720p	-	OK	-
1080i	OK	OK	OK

Output Texture	Clip In		
	PAL/NTSC	720p	1080i
PAL/NTSC	OK	OK	-
720p	OK	OK	-
1080i	OK	OK	OK

## 10.3.3 Source: 1080i

The first two tables show video in to DVE and texture output capabilities, while the next two tables show the clip in to DVE and texture output capabilities. Please observe that genlock families can not be mixed.

## Video In to DVE and Texture

Output DVE	Video In		
	PAL/NTSC	720p	1080i
PAL/NTSC	-	-	-
720p	-	-	-
1080i	-	-	OK
Output Texture	Video In		
	PAL/NTSC	720p	1080i
PAL/NTSC	-	-	OK
720p	-	-	OK
1080i	-	-	OK

## Clip In to DVE and Texture

Output DVE	Clip In		
	PAL/NTSC	720p	1080i
PAL/NTSC	OK	-	-
720p	-	OK	-
1080i	OK	OK	OK
Output Texture	Clip In		
	PAL/NTSC	720p	1080i
PAL/NTSC	OK	-	OK
720p	OK	OK	OK



Output Texture	Clip In		
1080i	OK	OK	OK

## 10.4 Frame Accurate Output

This section contains information on the following topics:

- [FAO Prerequisites](#)
- [Commands](#)
- [General Purpose IO Commands](#)
- [Timed Command Execution](#)

## 10.4.1 FAO Prerequisites

Frame accurate playout can be achieved by using a Timecode Reader card (for example, Plura AVPCL) and sending timed commands from any control application (like Media Sequencer). Scenes need to be loaded and cued some time ahead and then taken On Air at a given timecode. To make sure clip handling is fast, the system has to be configured to use either a RAID-0 hard disc configuration or SSDs.

Plura AVPCL boards can be used by Viz Engine if the driver is installed correctly. Please note that the config file needs to be modified to enable the Timecode sources within Viz Engine:

- The Timecode Reader Card for Viz Engine needs to be enabled in the Viz Config File by setting `TCReaderUsage = 2`.
- The correct timecode source must be set by using **TCReaderSource**. Viz Engine supports *LTC*, *VITC*, *ATC\_LTC*, *ATC\_VITC*, *HANC\_LTC*, *HANC\_VITC*, and *FIELDS*. To specify multiple sources the format would be: `TCReaderSource = LTC | VITC`.

Frame accuracy is only supported on Matrox boards.

Currently the following is supported:

Source	Notes	Supported
Live Input as Texture	Inputs need to be enabled in the scene and activated.	✓
Live Input as DVE		✓
Clip Playback as DVE	Currently not supported. Will be fixed in one of the next versions.	✗
Clip Playback as Container Texture	Currently only ClipTexturePlayer Renderer is supported.	✓

**⚠ Note:** Frame accurate Clip Playback using the Matrox player as DVE target is currently not supported.

**⚠ Note:** Initializing any Clip player can take a while. Therefore it is required to increase the output delay to prevent any framedrops.

## 10.4.2 Commands

To enable frame accurate handling of clips, it is necessary to preload the next scene by using the CUE command:

```
SCENE*<Scene Name> CUE
```

Because the loading time of clips is affected by disc speed and the used codec, allow at least a one second head start for the CUE command. The earlier you cue the next scene the more likely all of the clips are prepared when needed.

After the initial CUE command it is/could be necessary to send the following commands. If the scene was saved at another position than 0, send:

```
SCENE*<Scene Name>*STAGE SHOW 0.0
```

The following is always needed to finally set and activate the scene:

```
RENDERER SET_OBJECT SCENE*<Scene Name>
```

If the director is not configured to auto start you should use:

```
MAIN_SCENE*STAGE START
```

 **Note:** The first and last commands are optional.

### To Use the ClipTexturePlayer

The ClipTexturePlayer introduced in Viz Engine 5.3 allows to play a various range of broadcast and non broadcast clip formats (including transparency) without the need to utilize a certain clip channel. They can be used for promotion clips or similar.

The following prerequisites are needed:

- Add the clip to the stage by dragging the ClipTexturePlayer to a director within the stage.
- **Disable Liveplay** and animate the frames within the director.
- The Frames-per-second need to match the output frequency.

### Limitations

- ClipTexturePlayer is only available in Viz Engine Render Pipeline scenes, Classic Render Pipeline scenes are not supported.
- Audio is not supported (yet).

### 10.4.3 General Purpose IO Commands

Viz Engine can send and receive frame accurate commands via General Purpose input/output (GPIO), provided the following requirements are met:

- PCI or PCI Express Sealevel I/O device with eight, 16 or 32 digital inputs installed. Devices connected via Ethernet or USB cannot be used.
- Viz Engine 3.3 (rev 8394) or later to receive commands.
- Viz Engine 3.8.2 to send commands.
- A Matrox X.mio-series video board is required for getting the actual field which is played out.

This section contains information on the following topics:

- [Input Functionality](#)
- [Flow of the GPI signal](#)
- [Output Functionality](#)
- [Commands](#)
  - [Pin Command - Set](#)
  - [Command - Clear](#)
  - [Information - Get](#)
  - [Pin Command - Test](#)
  - [Enable - Set](#)
  - [GPO Command - Set](#)

#### Input Functionality

Currently, there are five commands available which enable you to queue commands for execution when a pin on the Sealevel board shows a raising or falling edge. For every Pin, an arbitrary amount of commands can be queued for the raising and falling event. Every command can be armed with a counter which tells Viz Engine how often the command should be executed before it is removed from the queue. A counter of 0 tells Viz Engine that the command should never be removed from the queue.

The following diagram illustrates the [Flow of the GPI signal](#) from the sender until the consequences of the executed command are rendered into the correct position in the Matrox ringbuffer. As soon as a **GPI sender** changes the status of a pin, connected to the **Sealevel device**, the change is reflected in an internal register of the card. In Viz Engine, a **thread** polls this register every millisecond. As soon as a change is found it calculates the timestamp for when the command should be executed.

The thread looks for the pin command in the **Command map** and queues the command into the **Timestamped commands** queue. As the actual depth of the Matrox ringbuffer, known the render loop, checks every field if it is time to execute a command from the queue. This guarantees that the command is executed at the correct field, no matter how large or full the ringbuffer actually is.

### Flow of the GPI signal

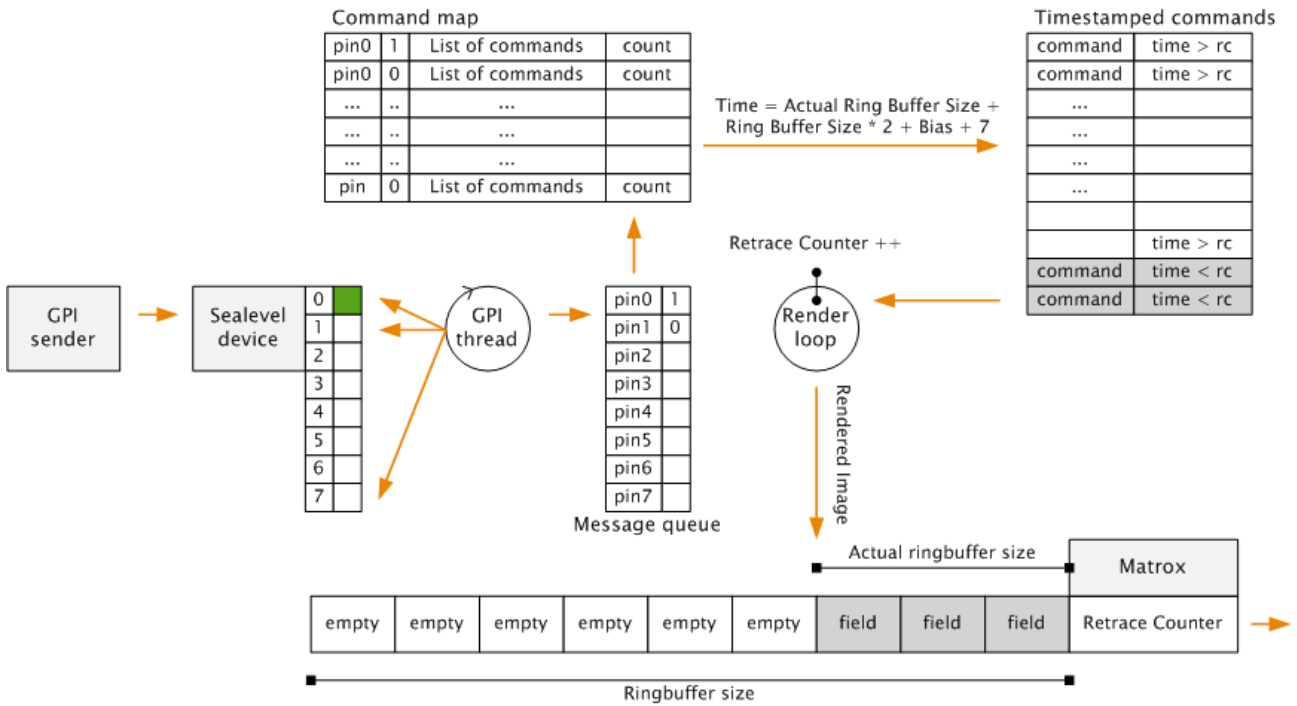

### Output Functionality

Since version 3.8.2, Viz Engine is able to send external triggers via GPIO on systems with a supported Sealevel GPI/O card installed, using the [GPO Command - Set](#). Depending on the GPI/O card configuration in the Sealevel driver, the first configured output channel could reside in a higher bank. For example, bank 2 -> first channel = 16.

**Note:** Only one channel can be sent at a time.

### Commands

The following are the available GPIO commands:

#### Pin Command - Set

```
VIZ_COMMUNICATION*GPI_PIN_COMMAND SET "<Command ID> <Command>" <PIN> <UP_DOWN> <COUNT>
```

Adds a command to the queue.

**Example:** `VIZ_COMMUNICATION*GPI_PIN_COMMAND SET "-1 RENDERER*MAIN_LAYER*STAGE START" 0 1 0`

- **<Command ID>**: The command ID specifier.
- **<Command>**: Command string which should be queued.
- **<PIN>**: Input pin number (valid from 0-31 ) where the first Pin is 0 .
- **<UP\_DOWN>**: 0 means the command should be executed on a falling edge, 1 means the command should be executed on a raising edge.
- **<COUNT>**: Executes the command <Count> times. The command executes once per event and NOT <Count> times per event. A value lower or equal to 0 means that the command is never removed from the queue.
- **Remarks**: After the GPI event occurs, the execution time of the command is calculated. The execution time is calculated in the following way:  $\text{Ring\_Buffer\_Size} \times 2 + 7 + \text{Delayed\_Command\_Bias}$  .  
The **<Delayed\\_Command\\_Bias>** can be set in the Viz Config file.  
Therefore,  $\text{Ring\_Buffer\_Size} \times 2 + 7$  is the minimum delay for GPI triggered commands.

## Command - Clear

```
VIZ_COMMUNICATION*GPI_PIN_COMMAND CLEAR <PIN> <UP_DOWN>
```

Clears all commands from the queue.

- **<PIN>**: Input Pin number (valid from 0-31 ) where the first Pin is 0 .
- **<UP\_DOWN>**: 0 simulates a command executed on a falling edge, 1 simulates a command executed on a raising edge.

## Information - Get

```
VIZ_COMMUNICATION*GPI_INFO GET
```

Sends information on the installed GPI device. If a valid device is present, the command returns the number of available GPI Banks. Therefore a value of 1 means that one bank (eight inputs) is available. If the command returns 0 no valid GPI device is present.

## Pin Command - Test

```
VIZ_COMMUNICATION*GPI_PIN_COMMAND TEST <PIN> <UP_DOWN>
```

Sends all queued commands for the pin and signal to the Viz Engine. The counter for the commands is not decremented.

- **<PIN>**: Input Pin number (valid from 0-31 ) where the first Pin is 0 .
- **<UP\_DOWN>**: 0 means the command should be executed on a falling edge, 1 means the command should be executed on a raising edge.

## Enable - Set

```
GLOBAL*GPI_ENABLE SET <1 or 0>
```

Enables or disables GPI commands for the Viz Engine. All functionality is available except of sending the commands on a GPI signal. If disabled, the command is shown in the console and a warning is shown, that GPI is disabled. The TEST command is working as usual, even if GPI is disabled.

- 1 enables GPI execution
- 0 disables GPI execution

## GPO Command - Set

```
VIZ_COMMUNICATION*GPO_BIT SET <bit> <state>
```

Sets the specified output channel to either **On** or **Off** :

- 1 is On .
- 0 is Off .

The command can be sent directly via the Viz Engine command line, via an action keyframe, or DataPool plug-ins.

 **Example:** send VIZ\_COMMUNICATION\*GPO\_BIT SET 17 1

 **IMPORTANT!** The bit count starts at 0 .



## 10.4.4 Timed Command Execution

To achieve frame accurate output at a certain time, Viz Engine utilizes a time code reader board and special commands. Viz Engine records certain commands and executes them at the exact time that the time code reader board hits the timestamp.

This section contains the following information:

- [Time Code Related Commands](#)
- [Prerequisites](#)
- [Configuration](#)

**Note:** Viz Engine can only guarantee a frame accurate output, not a field accurate output.

### Time Code Related Commands

Time Code	Description
TC*TC_INFO GET	Gives you all available time codes in the system. The return is a list of indexes and strings. Every time code source is identified by a unique index.
TC*TC_ACTIVE GET	Gives all time codes which have been updated in the last two fields.
TC*TC GET <index>	Returns the time code for the index.
TC*USED_TC GET	Returns the current used timecode by index
TC*USED_TC SET	Sets the timecode source by index.

Time Code	Description
<pre>TC*TC_COMMAND SET_TC &lt;index&gt; &lt;HH&gt;:&lt;MM&gt;:&lt;SS&gt;:&lt;FF&gt; F&gt; -1 COMMAND</pre>	<p>Queues a Command for execution on a specific time.</p> <p><b>&lt;index&gt;</b>: Index of the timecode.  <b>&lt;HH&gt;:&lt;MM&gt;:&lt;SS&gt;:&lt;FF&gt;</b>: The timecode in Hours, Minutes, Seconds and Fields.  <b>&lt;#&gt;</b>: Command answer identifier (currently only a value of <code>-1</code> is supported).  <b>COMMAND</b>: The Command to be executed.</p> <div style="border: 1px solid #ccc; padding: 10px; margin: 10px 0;"> <p><b>Example:</b> <code>TC*TC_COMMAND SET_TC 1 12:07:10:00 -1 RENDERER SET_OBJECT SCENE*&lt;9D1F7526-CFEF-C844-848279FE076E9104&gt;</code></p> </div> <p>Activates scene <code>&lt;9D1F7526-CFEF-C844-848279FE076E9104&gt;</code> at exactly 12:07:10:00.</p>
<pre>TC*TC CLEAR &lt;index&gt;</pre>	<p>Clears all queued commands for the time code source with index <code>&lt;index&gt;</code>.</p>
<pre>TC*DELETION_THRESHOLD SET &lt;TC&gt;</pre>	<p>Defines a time frame after which a command is removed when it has not been executed. The threshold needs to be defined as <code>hh:mm:ss:ff</code>. <code>&lt;TC&gt;</code> is a valid timecode.</p> <div style="border: 1px solid #ccc; padding: 10px; margin: 10px 0;"> <p><b>Example:</b> <code>TC*DELETION_THRESHOLD SET 00:00:10:00</code></p> </div>
<pre>TC*ACTIVATION_THRESHOLD SET &lt;TC&gt;</pre>	<p>Defines a time frame until when a command has to be executed (even if the given timecode has already passed). The threshold needs to be defined as <code>hh:mm:ss:ff</code>. <code>&lt;TC&gt;</code> is a valid timecode.</p>
<pre>TC*INSERT_THRESHOLD SET &lt;TC&gt;</pre>	<p>Defines a time frame into the future during which command are allowed to be executed when inserted. The threshold needs to be defined as <code>hh:mm:ss:ff</code>. <code>&lt;TC&gt;</code> is a valid timecode.</p> <div style="border: 1px solid #ccc; padding: 10px; margin: 10px 0;"> <p><b>Example:</b> <code>TC*INSERT_THRESHOLD SET 01:00:00:00</code></p> </div>

## Prerequisites

The following prerequisites are required:

- The system must be equipped with a Plura TC Reader board. This needs to be enabled in the Viz Config File by setting `TCReaderUsage = 2`.
- The correct TC source must be set by using `TCReaderSource`. Viz Engine supports LTC, VITC, ATC\_LTC, ATC\_VITC, HANC\_LTC, HANC\_VITC. To specify multiple sources the format would be: `TCReaderSource = LTC | VITC`.
- Commands need to be sent with a timecode.  
For example: `TC*TC_COMMAND SET_TC 1 12:00:00:00 -1 RENDERER*MAIN_LAYER SET_OBJECT SCENE*<9968FF26-35B0-4C01-AE5A4F8D11D1543B>`. This ensures that the mentioned scene is shown on the output exactly at 12:00:00:00.
- The Output delay should be set to a certain number of frames to prevent any frame drops (for example, to initialize clip codec, etc.).

**Note:** To verify this, make sure the final output device (Recorder, Monitor) can display the same timecode as attached to the Viz Engine.

## Configuration

To configure correct field accurate timeout, a few parameters need to be set. Three important values are responsible for the proper layout of Graphics, DVE Live sources and DVE Clips:

### Timed Command Bias

Command: `TC*TC_BIAS SET n (in fields)`  
Config Setting: `delayed_command_bias = n`

This represents the overall delay in fields, the commands are sent if the time code hits the timestamp. For instance, if your output appear two frames too late, you need to use `delayed_command_bias= -2`.

**Note:** The Command `TC*TC_BIAS SET n` immediately takes effect for all TC commands sent after this one, without restarting Viz Engine.

The correct sequence to bring a scene On Air exactly at 12:00:00:00 with clips prepared would then be:

```
SCENE*<uuid> LOAD
SCENE*<uuid> CUE

TC*TC_COMMAND SET_TC 1 12:00:00:00 -1 RENDERER*MAIN_LAYER SET_OBJECT SCENE*<uuid>
TC*TC_COMMAND SET_TC 1 12:00:00:00 -1 RENDERER*STAGE START
```

## 10.5 Shared Usage Of Input Channels

This feature allows two or more instances of Viz Engine on one system to show the same content by using the same physical input without the need for a distribution amplifier.

### 10.5.1 Configuration

To share the input, all instances must have their corresponding input channels configured the same to be used.

**Example:** `live_type1 = SDI1`

The Viz Engine instance hosting the physical input needs the following value set in the config file:

```
Matrox.InputHost = 1
```

**Important:** Using shared inputs and setting this configuration value increases the overall in-to-out delay by 1 frame.

### 10.5.2 Important

The first instance of Viz Engine that is started owns the physical connector of the input. All other instances started after share the content on the video board. If the first instance (in control of the input connector) is closed, all other instances referring to that connector lose their content as well, and need to be closed and restarted again. There is no automatic recovery when the owning instance of Viz Engine crashes.

**Note:** It is imperative that the first engine fully boots before the others can allocate the shared resource.

Watchdog configuration is also not supported in this case.

**Info:** This feature is available on system topology SDI boards only (x.mio3, DSX.LE4 and successors).

**Info:** This feature also works if the requested connector is physically allocated by a Channel Recorder instance.

### 10.5.3 Sharing Inputs on X.mio5 ST 2110 Boards

This feature works differently on ST 2110 boards. It is possible to subscribe to the same multicast address on multiple connectors. Network switches won't send the same IP packet twice, so no bandwidth is lost. In an NMOS environment, this is straight forward by connecting the same sender to different receivers. For static (and potentially some SDN) setups, it is necessary to configure the same multicast address on the inputs in *ipconfig.xml*.

The important benefit of this approach compared to the dual channel SDI setup is that the inputs work individually, and the shutdown or stopping of one Viz Engine instance doesn't influence the other.

---

## 10.6 Dynamic Channel Allocation

As of now, whenever you need an additional input or clip channel, you need to open the configuration, set the channel to the desired resolution on the Video Input page and restart Viz Engine. Only after that, the channel becomes available.

The dynamic allocation allows to dragging the resource from the Media Assets to your scene for immediate use. It uses the default values and the output resolution for configuration. If you need a different resolution for that specific channel, enter Video Input configuration, and select the resolution. The Media Asset can be used afterwards, without the need to restart Viz Engine.

### 10.6.1 Limitations

- Only dynamic adding of channels is supported at the moment. Removal is possible only by setting the channel to `Invalid` in the configuration, then restarting Viz Engine.
- The maximum number of channels has not changed.
- Dynamic allocation is only supported for inputs. Outputs cannot be acquired on demand.

 **Note:** This feature is meant to be used during design mode only!

---

## 10.7 Matrox Supported Codecs

The Matrox X.mio series cards all support a selection of different codecs for both SD and HD. Certain codecs require certain card classes. Depending on the card class, a license upgrade may be required to extend the range of codecs supported by the installed video card. The Matrox video cards have a built-in license dongle used by the Matrox codecs to determine licensing rights.

- For the Matrox X.mio and DSX LE video cards, the following classes apply:
  - **100 class:** No clip playback.
  - **500 class:** SD and HD clip playback.
  - **550 class:** SD and HD clip playback, including support for Apple ProRes codecs.

 **IMPORTANT!** The Codec DNxHD requires its own license, issued by Vizrt.

All codecs are implemented in the software. For all full detailed overview of supported codecs, please refer the **Supported Codecs** page in the **Media Assets** section of the [Viz Artist User Guide](#).

## 10.8 DVE Performance

This section contains information on the following topics:

- [General Information](#)
- [X.mio5](#)
- [X.mio3](#)
  - [Single Channel Performance \(1080i50\)](#)
  - [Dual Channel Performance \(1080i50\)](#)

### 10.8.1 General Information

The number of DVE channels that can be used in Viz Engine depends on the video hardware. The limiting factor is the amount of memory on the card, but also the available bandwidth for transfers between the FPGA and the on-board memory. For example, on a [Matrox X.mio3](#) card, you can scale eight 1080i surfaces to 99.9% and compose those eight surfaces at the same time. If the scaling factor is reduced, the overall DVE performance increases, due to the lowered amount of bandwidth needed. At a certain point, it might even be possible to add an additional DVE input. Looking at a single channel system fit with an X.mio3, nine inputs can be used as DVE, as one is always consumed by the background layer. However, setting the system up as dual channel, reduces the amount of DVE layers to three in each channel, considering that two background layers are used.

### 10.8.2 X.mio5

**Input mapping used : 11in1out**

Rate	Scaling	Foreground/ Background	Inputs possible without significant performance issues
UHD 50 Hz	100%	1	4 UHD + 2 FullHD
UHD 50 Hz	100%	0	5 UHD + 1 FullHD / 4 UHD + 5 FullHD
UHD 50 Hz	99%	1	4 UHD + 2 FullHD
UHD 50 Hz	99%	0	5 UHD + 1 FullHD / 4 UHD + 5 FullHD
UHD 50 Hz	50%	1	5 UHD
UHD 50 Hz	50%	0	5 UHD + 1 FullHD
UHD 50 Hz	33%	1	5 UHD + 1 FullHD
UHD 50 Hz	33%	0	5 UHD + 1 FullHD

Rate	Scaling	Foreground/ Background	Inputs possible without significant performance issues
UHD 60 Hz	100%	1	3 UHD + 3 FullHD
UHD 60 Hz	100%	0	4 UHD + 1 FullHD
UHD 60 Hz	99%	1	3 UHD + 3 FullHD
UHD 60 Hz	99%	0	4 UHD + 1 FullHD
UHD 60 Hz	50%	1	4 UHD + 1 FullHD
UHD 60 Hz	50%	0	4 UHD + 1 FullHD
UHD 60 Hz	33%	1	4 UHD + 1 FullHD
UHD 60 Hz	33%	0	4 UHD + 2 FullHD

### 10.8.3 X.mio3

#### Single Channel Performance (1080i50)

The maximum number of DVE Assets (excluding Fore- and Background layer) on **X.mio3**:

Size	Maximum
100%	9
99%	9
33%	10 (Break even point ~95%)

#### Dual Channel Performance (1080i50)

The maximum number of DVE Assets (excluding Fore- and Background layer) on **X.mio3** for each single channel:

Size	Maximum
100%	4
99%	4



Size	Maximum
33%	4

 **Note:** The asterisk (\*) denotes measurements are done with DSX Utils 9.8.0.22112 on Viz Engine 3.9.0.66266.

## 10.9 Watchdog

A watchdog is essentially a timer that allows a system to continue video pass-through when an application has crashed or there is a system failure. Matrox X.mio3 boards have a built-in watchdog capability; however, the bypass only works for video (including optional embedded audio), while AES audio is not bypassed.

 **Note:** The watchdog feature is only available on the X.mio3 board.

This section contains the following topics and procedures:

- [Mechanical Bypass](#)
- [Hardware Bypass](#)
- [Transition from Watchdog to Video](#)

### 10.9.1 Mechanical Bypass

A relay (input to output) that works in case of a power loss.

### 10.9.2 Hardware Bypass

Operates in a powered machine state (input to the board's output). In hardware bypass mode the incoming video and reference signals must be compliant to provide the correct watchdog functionality.

 **Tip:** The hardware bypass introduces an h-phase on the output. The value of this phase depends on the video output format.

### 10.9.3 Transition from Watchdog to Video

There are three possible settings which control when to deactivate the watchdog after Viz Engine is restarted.

- **0:** Deactivated as soon as the first geometry is loaded to Viz Engine.
- **1:** Deactivated as soon as Viz Engine finished the startup process. In this case, black plays out as no scene is loaded yet.
- **2:** Deactivated as soon as either the first geometry is loaded to Viz Engine or a live input as DVE is used in the scene, or both.

When watchdog is deactivated (with `video_loopthrough_mode=2`) and a scene with DVE input is loaded, a few black frames are shown. The watchdog should be activated after the input channel is ready. To provide a glitch free transition from watchdog to video, configure the watchdog's deactivation delay by setting the delay in fields for the watchdog to wait before deactivation.

## 10.10 NDI Output From GFX Channel

This allows to send content from any GFX Channel in a scene to a separate NDI output stream. The resolution of the NDI output stream is equal to the resolution of the GFX Channel itself, with the width rounded down to the nearest even number. The scan mode of the NDI stream is always progressive, and it does not include audio. The possible number of concurrent outputs depends on resolution, CPU performance and available network bandwidth.

**✘ Important:** The Parallel Outputs license is necessary to use this feature.

**✘ Important:** Parallel Outputs supports GFX channels only in Texture mode. If the resolution of the scene in the GFX channel exceeds 2048 pixels in either direction, the 4K Video Enablement license is required in addition. Exceeding 4096 pixels is not supported.

### 10.10.1 Configuration

The name of the NDI sender can be configured per GFX Channel in the Viz Engine configuration file and defaults for example to `# Gfx1.NDIAuxName = VizEngine-0 GFX-1` for GFX Channel 1 on Viz Engine instance 0.

### 10.10.2 Operation

To enable the NDI output stream, either click the checkbox in the pane shown (screenshot below) or send the following command (with  $n$  being the number of the GFX Channel):

```
MAIN_SCENE*GFX*n*NDI_AUX*MODE SET SEND
```

To stop sending untick the checkbox again or send the command (with  $n$  being the number of the GFX Channel):

```
MAIN_SCENE*GFX*n*NDI_AUX*MODE SET INACTIVE
```

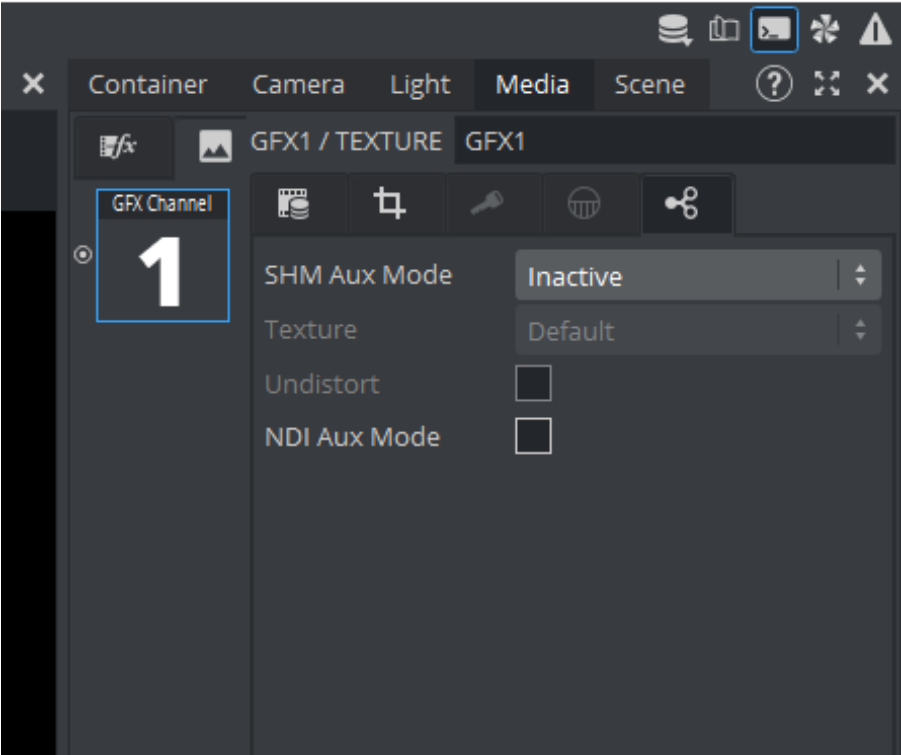

## 10.11 Clip Player Pro Features

Viz Engine supports new codecs using the VML clip player.

**Important:** The Clip Player Pro license is required to use these codecs.

### 10.11.1 H.265

HEVC/H.265 encoded clips can be played using the VML clip player. The clips are decoded on the CPU, which might result in a high CPU load depending on the clip resolution. If hardware-accelerated playback is enabled, it is possible to decode it using GPU; however, not all GPU supports decoding of H.265 encoded clips. It is recommended that the duration of a GOP does not exceed 0.5s.

### 10.11.2 HAP

The VML clip player in Viz Engine currently supports HAP 1, HAP 5 and HAP Y encoded clips. Clips using these codecs can directly be used by the GPU, which results in minimal CPU performance impact. However, due to the size of the clips, disk performance and general data throughput of the system are affected.

### 10.11.3 GPU Hardware Acceleration / NVDEC

VML clip player supports NVDEC hardware acceleration for supported codecs like H.264 or H.265. A Clip Player Pro license is required to enable the GPU clip decoding. Without a license, decoding is done on the CPU.

#### GPU Requirements

Tested on:

1. NVIDIA GA104 [GeForce RTX 3070 Ti] (Ampere Architecture)
2. NVIDIA RTX 4000 SFF Ada generation (Ada Lovelace)
3. NVIDIA RTX A2000 (Ampere Architecture)

Details of architecture/family can be found here: <https://docs.nvidia.com/video-technologies/video-codec-sdk/12.1/nvdec-video-decoder-api-prog-guide/index.html>.

- **Supported Codecs:** H.264, H.265, AV1
- **Supported Pixel Formats:** NV12, YUV420p, P016, YUV420p10le
- **Supported Containers:** MP4
- **Bit Depth:** 8-bit and 10-bit
- **Audio Codec:** AAC, PCM

#### Enable Hardware Accelerated Playback

```
## Allow using NVDEC to decode clips
#* clip_use_NVDEC: Default=0
```

```
# clip_use_NVDEC = 0  
clip_use_NVDEC = 1
```

## Limitations

1. 12-bit bit depth not tested or supported.
2. Interlaced is not supported for hardware-accelerated video decoding.

 **Note:** The clip channel must be configured manually to progressive to be able to play with NVDEC.

3. It is not possible to choose which GPU to use (for decoding clips) in a multi-GPU setup.

---

## 11 SMPTE 2110 Information

The following chapters include an introduction into SMPTE 2110 standard as well as some common practices, guides and troubleshooting sections:

- [General Information and Introduction](#)
- [Configuring a Static Network](#)
- [Working with NMOS](#)
- [Troubleshooting SMPTE ST2110 and NMOS](#)
- [Explicit Usage of the Second SFP Pair on Matrox X.mio5 Q25](#)

## 11.1 General Information And Introduction

### 11.1.1 General Description

From a pure Viz Engine viewpoint, the main standards we have to deal with are SMPTE ST 2110-20 (video), -30 (audio) and -40 (ancillary data) as well as SMPTE ST 2059-2 (synchronization profile). Those elements are transported in the essence network. If NMOS is also part of the infrastructure, a separate management network might be available. In addition to the standards mentioned before, other IT infrastructure elements, like DNS and DHCP, could be available.

A typical SMPTE ST 2110 network consists of various endpoint devices connected to one or more switches. The switches might be arranged in a spine-leaf architecture, with high bandwidth backbone switches and lower bandwidth leaf switches where the devices connect to. Additionally, one or more PTP clocks are required for synchronization. Having DHCP and/or DNS servers running in your network could increase manageability.

In NMOS controlled networks, an RDS and a Network Orchestrator/Controller might be part of the infrastructure as well, although not all NMOS Controllers need a registration server, as they are sending RESTful calls directly to the devices.

### 11.1.2 Standards

#### SMPTE ST 2110

Standard	Definition
2110-20	Uncompressed video flows.
2110-21	Defines traffic shaping and delivery timing. Defines terms like Narrow Sender/Receiver and Wide Sender/Receiver.
2110-22	Constant Bit-Rate Compressed video flows.
2110-30	Uncompressed audio flows.
2110-31	Compressed audio flows according to AES3.
2110-40	Ancillary data flows.



Standard	Definition
2110-41	Fast metadata flows (WIP).

## AMWA NMOS



Id	Name	Description
IS-04	Discovery & Registration	Allows control and monitoring applications to find the resources on a network.
IS-05	Device Connection Management	Provides a transport-independent way of connecting Media Nodes.
IS-06	Network Control	Lets broadcast control applications manage what happens on the network itself.
IS-07	Event & Tally	Provides an IP-friendly mechanism to carry time-sensitive information, like tally or event data. Is similar to GPIO in a traditional broadcast environment.
IS-08	Audio Channel Mapping	Allows channel-level operations within NMOS environments like channel muting, language swapping,...
IS-09	System Parameters	Allows an NMOS Node to obtain global configuration parameters that are common across the system.
IS-10	Authorization	Allows an API server to accept or reject requests depending on what a client is authorized to do.
IS-11	Sink Metadata Processing	Provides information about physical devices called Sinks associated with Receivers. Allows to configure media parameters of Senders based on information about Sinks.
MS-04	ID & Timing Model	Documents a model for identity and timing that applies to AMWA NMOS specifications that apply to content
MS-05-01	NMOS Control Architecture Framework	Defines a system for modelling various types of devices which interrelates with existing NMOS Specifications and the JT-NM Reference Architecture.

Id	Name	Description
BCP-0 02-01	Natural Grouping	Documents best practice and recommendations for how to indicate and handle “Natural Groups” of Resources in AMWA NMOS APIs.
BCP-0 03-01	Secure Communications in NMOS Systems	Documents best practice for using secure transport for NMOS API communications.
BCP-0 03-02	Authorization in NMOS Systems	Documents best practice for an API server to accept or reject requests depending on what a client is authorized to do.
BCP-0 03-03	Certificate Provisioning in NMOS Systems	Documents best practice for automated provisioning of TLS Server Certificates to NMOS APIs.
BCP-0 04-01	Receiver Capabilities	Allows an IS-04 Receiver to express parametric constraints on the types of streams that it is capable of consuming.
BCP-0 05-01	EDID to Receiver Capabilities Mapping	Provides a scheme and guidelines for expressing EDID information via Receiver Capabilities.

See [Networked Media Open Specifications](#) for more details.

### 11.1.3 Definition of Terms

Term	Definition/Explanation
SMPTE ST 2110	A <a href="#">series of specifications</a> covering various aspects of transporting media content over IP, as well as describing the related infrastructure topics.
AMWA NMOS	<a href="#">Advanced Media Workflow Association Networked Media Open Specification</a> A family of specifications that enable interoperability between media devices on an IP infrastructure.
IGMP	The <a href="#">Internet Group Management Protocol</a> is a communication protocol used by hosts and adjacent routers on IPv4 networks to establish multicast group memberships. It is an integral part of IP multicast and allows the network to direct multicast transmissions only to hosts that have requested them.
SDP	The Session Description Protocol is a format for describing multimedia communication sessions. NMOS IS-05 uses the SDP to describe the content and format of the sender flow, to which a receiver should connect to.

Term	Definition/Explanation
SFP	<p>A Small Form-Factor Pluggable is a compact, hot-pluggable network interface module used together with a Fiber-Optics cable to connect SMPTE ST 2110 devices to a switch.</p> 
AOC	<p>Active Optical Cable have the optical electronics already connected, eliminating the connectors between the cable and the optical module.</p> 
DAC	<p>Direct Attach Copper use twin-axial copper cables directly attached to the SFP.</p>
FEC	<p><a href="#">Forward Error Correction</a> is a technique used for controlling errors in data transmission.</p>
PTP	<p><a href="#">Precision Time Protocol</a> is a protocol used to synchronize clocks throughout a computer network. For broadcast media systems the PTP profile defined in SMPTE 2059-2 is required.</p>
BMCA	<p>The Best Master Clock Algorithm is a method to determine the best clock based on a series of properties.</p>
<a href="#">In-Band</a>	<p>Describes the method to send management data on the same network as the media data.</p>
<a href="#">Out-of-Band</a>	<p>Describes the method to send management data over a network separated from the media data network.</p>
DHCP	<p>The <a href="#">Dynamic Host Configuration Protocol</a> is a network management protocol used for automatically assigning IP addresses.</p>
DNS	<p>The <a href="#">Domain Name System</a> is a hierarchical and decentralized naming system for computers, services, or other resources connected to the network.</p>

Term	Definition/Explanation
DNS-SD	<a href="#">DNS-based Service Discovery</a> allows clients to discover a named list of service instances and to resolve those services to hostnames using standard DNS queries.
RDS	A Registration & Discovery Server is used to register Nodes, Devices, Senders and Receivers in a centralized place using NMOS IS-04.
SDN	Software-defined networking technology is an approach to network management that enables dynamic and efficient configuration.
REST	<p><a href="#">Representational state transfer</a> defines a set of constraints for how the architecture of a big network infrastructure should behave.</p> <p>A web API that obeys the REST constraints is informally described as RESTful and is typically loosely based on HTTP methods to access resources via URL-encoded parameters and the use of JSON or XML to transmit data.</p>
NIC	A Network Interface Controller is a computer hardware component that connects a computer to a computer network.
MAC addresses	A Media Access Control address is a unique identifier assigned to a NIC for use as a network address in communications within a network segment.

---

## 11.2 Configuring A Static Network

### 11.2.1 What is a Static IP Setup

When talking about static IP networks for SMPTE ST 2110, we need to distinguish between static TCP/IP addresses for the ports and static multicast address assignment for the single flows.

#### Static TCP/IP Address Assignment

If no DHCP server is available for your essence and management networks, IP address, subnet mask and gateway address need to be assigned statically in the various network settings. Proper planning of the network segments is essential to minimize the risk of conflicts. However, the danger of incorrectly assigned addresses is generally high in such an environment.

#### Static Configuration of Matrox IP Video Boards

Matrox X.mio3 IP does not support DHCP and IP address, subnet mask and gateway for the PTP network segment need to be configured in *ipconfig.xml* located in `\\%ProgramData%\vizrt\VizEngine`.

Matrox X.mio5 IP supports DHCP for both the PTP network (*ipconfig.xml*) and the Windows network stack. In case of static configuration, *DhcpEnable* needs to be set to false and IP address, subnet mask and gateway must be set manually for every used SFP section in *ipconfig.xml*. Additionally, every Matrox related NIC must be configured statically in the Windows network configuration section.



**Important:** Every port (SFP) of a Matrox X.mio5 has two different MAC addresses and thus **must** have two separate IP addresses for each, Windows NIC and PTP settings.

#### Static Multicast Address Assignment

Some of the routers/switches available for SMPTE ST 2110 infrastructure still work like a classical SDI router, and rely on static assignment of the multicast addresses of the different senders and receivers. The switching is done by the router and not by subscribing to different sender multicast addresses.

In such an environment, the multicast addresses and ports for every sender and receiver must be configured in the *ipconfig.xml*. The *EnableFlow* flag must also be set to true in that case.

It is recommended to turn on *AutoRecovery* also, to make sure all changes made during run-time are written back to *ipconfig.xml*.

### 11.2.2 Examples

Static config in *ipconfig.xml*:

```

<SFP name="SFP A">
  <IPv4Address>10.10.10.2</IPv4Address>
  <IPv4Gateway>10.10.10.1</IPv4Gateway>
  <IPv4Netmask>255.255.255.0</IPv4Netmask>
  <Smpte2059SfpSettings>
    <DhcpEnable>false</DhcpEnable>
</SFP name="SFP A">

<Video name="IP video IN 1">
  <EnableFlow>true</EnableFlow>
  <RtpPayloadId>96</RtpPayloadId>
  <GroupHint>IP In Channel 1</GroupHint>
  <Label>IP Video In 1</Label>
  <Description>IP Video In 1</Description>
  <Primary>
    <DstAddress>239.9.20.1</DstAddress>
    <DstUdpPort>50020</DstUdpPort>
  </Primary>
</Video name="IP video IN 1">

```

Static config in Windows network settings:

#### Internet Protocol Version 4 (TCP/IPv4) Properties

General

You can get IP settings assigned automatically if your network supports this capability. Otherwise, you need to ask your network administrator for the appropriate IP settings.

Obtain an IP address automatically

Use the following IP address:

IP address:	10 . 10 . 10 . 3
Subnet mask:	255 . 255 . 255 . 0
Default gateway:	10 . 10 . 10 . 1

Obtain DNS server address automatically

Use the following DNS server addresses:

Preferred DNS server:	10 . 10 . 10 . 1
-----------------------	------------------

---

## 11.3 Working With NMOS

### 11.3.1 What is NMOS

The Networked Media Open Specifications provide an open and simple to use control - plane solution that enables interoperability and management of IP connected audio and video devices. They let you find, connect and configure media devices to enable video and audio on your IP network. NMOS is open, industry developed, free of charge and available to everyone. Initially, it was designed to support SMPTE ST 2110, with the possibility for other transport standards as well. NMOS is a fundamental part of the JT - NM technical recommendation, JT - NM TR - 1001, enabling operational efficiency through automation and by reduction of manual overhead in setting up networked systems.

### 11.3.2 A Typical NMOS Environment

The central part in a typical NMOS setup is the Registration & Discovery Server. Every node, device, sender and receiver is registered there and can be discovered using NMOS IS-04. NMOS controllers/orchestrators can then be used to create NMOS IS-05 requests by use of SDPs to tell a receiver to subscribe to a certain sender's multicast address. The NMOS controller can also be used to assign multicast addresses to the senders, which allows centralized management of the multicast address/port assignment.

### 11.3.3 How to Configure NMOS on Viz Engine Systems

#### Settings Related to the Matrox Driver

By default, NMOS control is turned off. To enable it, a file which is part of the Matrox driver installation, needs to be edited. The file can be found in `%PROGRAMFILES%\Matrox DSX-TopologyUtils\System64`. Its name is the serial number of your Matrox board followed by the extension `.json` (for example, `A654321.json`).

The following value must be set to true as shown:

```
"enabled": true,
```

Additionally, the registration server must be configured in case DNS-SD is not enabled (example):

```
"fallback registration server": {  
  "api version": "auto",  
  "host name": "10.1.1.127",  
  "port": 50000  
},
```

DNS service discovery can be enabled or disabled using that flag:

```
"use service discovery": true,
```

All other values are either not relevant for Viz Engine setups yet, or are set by Viz Engine when started for the first time.

## Settings Related to Viz Engine

Certain settings in *ipconfig.xml* are related to NMOS, and can be edited directly in that file. If they are not changed, default values are being used. The following values are used for registering the node and device (examples):

```
<!--Name of the NMOS IS-04 node to be used.-->
<NmosNode>Vizrt Node on hostname</NmosNode>
<!--Name of the NMOS IS-04 device to be used.-->
<NmosDevice>Vizrt Device on hostname</NmosDevice>
```

Every sender and receiver now uses two values to identify it at the registration server (examples):

```
<Label>IP Video Out 1</Label>
<Description>IP Video Out 1</Description>
```

json etc..



## 11.4 Troubleshooting SMPTE ST2110 And NMOS

### 11.4.1 Known Issues

Issue	Solution
Audio does not work anymore after upgrade to Viz Engine 4.3.0 (or higher)	Viz Engine 4.3.0 introduces Group Hints to group together video, audio and ancillary data flows. Flows with the same group hint create a channel based on the hint of the video flow. If no audio flow uses the same group hint, no audio connector will be created. <b>Advance notice:</b> The next major version of Viz Engine will introduce Group Hints which are conformant with NMOS specifications. Free of choice group hints can still be used, but they cannot be sent to registration servers.
NMOS does not work anymore after a Matrox driver upgrade	Matrox changed the structure of the <i>serial.json</i> in their latest driver versions. Please verify all the settings in this file, especially the <i>enabled</i> setting.
My static network settings are changed after a driver upgrade	Unfortunately uninstalling the Matrox driver deletes all settings of the NICs created for X.mio5. This is expected, as Windows is removing all related devices when the drivers are removed. Please check and reapply the IP settings for the Matrox ethernet adapters after installing the new driver. <b>Advance notice:</b> Future Matrox drivers will try to preserve the Windows network settings if a static configuration is used.

### 11.4.2 SMPTE ST 2110

Issue	Possible Solution
Matrox board doesn't lock to Blackburst	<ul style="list-style-type: none"> <li>X.mio3: make sure the cable is properly connected and that a stable sync signal is available.</li> <li>X.mio5: although early X.mio5 boards still have a genlock connector, Blackburst should not be used with this boards, as the driver doesn't support proper locking anymore.</li> </ul>

Issue	Possible Solution
Matrox board doesn't lock to PTP	<ul style="list-style-type: none"> <li>• Make sure SFPs and fiber optics are properly installed and attached. The status of the SFPs can be checked in X.info.</li> <li>• Make sure that you have a valid link. Green LEDs on the board and on the switch show a correct link. At least SFP A needs to be used.</li> <li>• Make sure that both sides of the connection use SFPs with the same nominal transfer rate, and the same range classification.</li> <li>• Make sure you use the correct combination of cable and SFPs - Short Reach or Long Reach.</li> <li>• Make sure the correct IGMP join type is set in the IP config file. This needs to match the settings on the IP switch.</li> <li>• Make sure that the correct IP address, gateway if necessary, and subnet mask is set in the IP config file, if you don't use DHCP, or that DHCP is enabled in the IP config file.</li> <li>• Make sure the master clock domain number is set correctly in the IP config file.</li> <li>• Make sure the ports on the IP switch are configured to route PTP, or that the switch has PTP enabled at all.</li> </ul>
Matrox board doesn't receive flows on the inputs	<ul style="list-style-type: none"> <li>• Make sure the flow is enabled. You can use <code>MAIN*CONFIGURATION*CHANNELS*LIVEIN_n*ENABLEDSTATE GET</code> to verify.</li> <li>• Make sure destination address and UDP port are set correctly and match the sender. You can use <code>MAIN*CONFIGURATION*CHANNELS*LIVEIN_n*DSTADDRESS GET</code> and <code>...*DSTUDPPORT GET</code> to verify.</li> <li>• On X.mio3 make sure the sender is a narrow sender.</li> <li>• For audio on X.mio5 make sure the configuration matches exactly the flow settings - number of channels, audio packet duration.</li> <li>• Make sure the correct IGMP join type is set in the IP config file. This needs to match the settings on the IP switch.</li> <li>• Make sure SFPs and fiber optics are properly installed and attached. The status of the SFPs can be checked in X.info.</li> <li>• Make sure that you have a valid link. Green LEDs on the board and on the switch show a correct link. At least SFP A needs to be used.</li> <li>• Make sure that both sides of the connection use SFPs with the same nominal transfer rate, and the same range classification.</li> <li>• Make sure you use the correct combination of cable and SFPs - Short Reach or Long Reach.</li> <li>• Make sure you have a valid SDI/IP input license.</li> </ul>

Issue	Possible Solution
Output of Matrox board cannot be received on other devices	<ul style="list-style-type: none"> <li>• Make sure the flow is enabled. You can use <code>MAIN*CONFIGURATION*MATROX*VIDEOOUT_n*ENABLEDSTATE GET</code> to verify.</li> <li>• Make sure you have configured a valid source address on your SFPs and UDP port on your outputs. You can use <code>MAIN*CONFIGURATION*MATROX*VIDEOOUT_n*SRCADDRESS GET</code> and <code>...*SRCUDPPORT GET</code> to verify.</li> <li>• Make sure you have configured valid destination multicast addresses and ports for your outputs. You can use <code>MAIN*CONFIGURATION*MATROX*VIDEOOUT_n*DSTADDRESS GET</code> and <code>...*DSTUDPPORT GET</code> to verify.</li> <li>• Make sure SFPs and fiber optics are properly installed and attached. The status of the SFPs can be checked in X.info.</li> <li>• Make sure that you have a valid link. Green LEDs on the board and on the switch show a correct link. At least SFP A needs to be used.</li> <li>• Make sure that both sides of the connection use SFPs with the same nominal transfer rate, and the same range classification.</li> <li>• Make sure you use the correct combination of cable and SFPs - Short Reach or Long Reach.</li> <li>• Make sure you have a valid SDI/IP output license.</li> </ul>
Matrox board doesn't work at all, when using UHD resolution	<ul style="list-style-type: none"> <li>• X.mio3: UHD is not supported on X.mio3</li> <li>• X.mio5: Make sure to use SFPs with a nominal transfer rate of 25GbE on both your switch and the video board. The switch must support 25GbE transfer rates as well.</li> </ul>
Matrox has trouble detecting SFP when switching between 10GbE and 25GbE SFPs	<ul style="list-style-type: none"> <li>• Make sure you do a restart or a cold reboot.</li> </ul>

## 11.4.3 NMOS

Issue	Possible Solution
Neither the node nor the device shows up in the registry	<ul style="list-style-type: none"> <li>• Check, if NMOS is enabled in the JSON file associated with that device. The file <i>serialnumber.json</i> can be found in <i>%ProgramFiles%\Matrox DSX-TopologyUtils\System64</i>.</li> <li>• Make sure to set either <i>use service discovery</i> to true or to enter a valid <i>registration server IP</i> and <i>registration server port</i>.</li> <li>• Verify that your device can be registered by opening <i>http://localhost:port/x-nmos/node/v1.3/devices/</i>. The <i>port</i> is also defined in the JSON with <i>control port</i>.</li> </ul>
Neither senders nor receivers show up in the registry	<ul style="list-style-type: none"> <li>• Senders and receivers are only registered when they are used. Start Viz Engine to register all used outputs and inputs. Senders and receivers will be unregistered when Viz Engine is closed.</li> <li>• Verify that your senders/outputs can be registered by opening <i>http://localhost:port/x-nmos/node/v1.3/senders/</i>. <i>port</i> is also defined in the JSON with <i>control port</i>.</li> <li>• Verify that your receivers/inputs can be registered by opening <i>http://localhost:port/x-nmos/node/v1.3/receivers/</i>. <i>port</i> is also defined in the JSON with <i>control port</i>.</li> </ul>
NMOS IS-05 connection requests are ignored	<ul style="list-style-type: none"> <li>• Check Viz Engine console for error messages.</li> <li>• Requests are only accepted, if the incoming flow matches the configuration in regard to resolution, frame rate and scan mode.</li> <li>• IS-05 requests can be used to schedule a change for a later point in time. Make sure to wait until this time is reached.</li> </ul>

---

## 11.5 Explicit Usage Of The Second SFP Pair On Matrox X.mio5 Q25

If the total bandwidth of all connections exceeds the available bandwidth or if an input or output needs to be moved explicitly to the second SFP pair, the following applies:

Connectors on the second SFP pair start at the values listed below:

- Video connectors on SFP C start at 17.
- Audio connectors on SFP C start at 129.
- Ancillary data connectors on SFP C start at 33.

 **Information:** For inputs this happens automatically during configuration based on the nominal bit rate of the selected resolution.

### 11.5.1 Examples

#### Example 1

Single Channel setup with ten 1080p inputs, input configuration:

- Input channel 1 - 8 mapped to IP input 1 - 8.
- Input channel 9, 10 mapped to IP input 17, 18.

#### Example 2

Dual Channel setup in UHD with fill/key, output configuration:

- Viz Engine 1 program output mapped to IP output 1, IP output 2 is used by the key.
- Viz Engine 2 program output mapped to IP output 17, IP output 18 is used by the key.

---

## 12 Audio In Viz Engine

This section contains the technical description of the Viz Engine audio system, and contains the following information:

- [Overview](#)
- [Device Recognition and Selection](#)
- [Timing Behavior and Delay Settings](#)
- [Audio Plug-in](#)
- [Clip Formats](#)
- [Speaker Names](#)
- [Emergency Alert System](#)
- [Shared Memory Integration of Channel Volume Levels](#)
- [Dolby E Configuration](#)
- [Channel Setup and Clip Channel Routing](#)
- [Matrox Audio](#)

## 12.1 Overview

There are two ways to capture audio in the Viz Engine, through Matrox or a DirectSound compatible device.

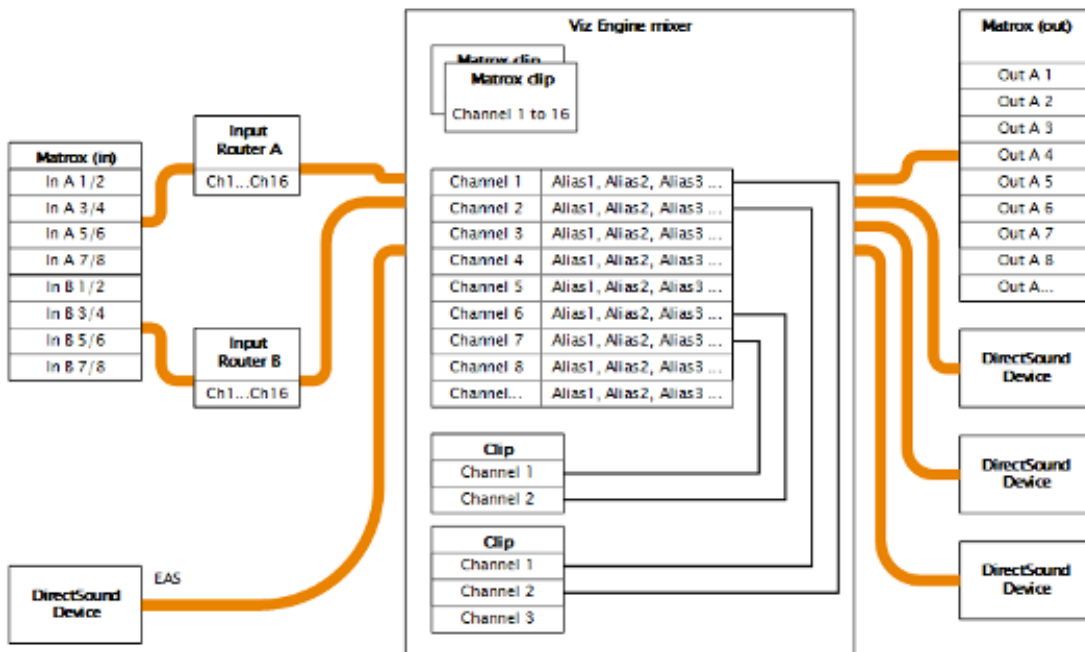

This page contains information on the following topics:

- [Channels](#)
  - [Audio Channels](#)
  - [Matrox Input Channels](#)
  - [Output Channels](#)
- [Matrox Routing](#)
  - [Matrox Live Input Routing](#)
  - [Matrox Clip Routing](#)
- [DirectShow](#)
  - [DirectShow Filters](#)
  - [DirectSound Input](#)
  - [DirectSound Audio Card](#)

### 12.1.1 Channels

#### Audio Channels

Viz Engine handles up to 16 audio channels for both input and output. This corresponds to the maximum number of embedded audio channels on an HD-SDI video source. Every channel can be given one or more user-defined aliases.

## Matrox Input Channels

If using Matrox video hardware, the 16 input channels are available as AES/EBU input or embedded audio.

## Output Channels

After mixing, the Viz Engine writes the audio data to the available output devices.

### 12.1.2 Matrox Routing

#### Matrox Live Input Routing

On Matrox cards, it is possible to route live input channels to any internal Viz Engine output channel. Several channels can be routed to a single internal channel, but it is not possible to duplicate input channels.

#### Matrox Clip Routing

Audio from Matrox clips are mapped one by one to the internal Viz Engine channels; hence, no routing is possible. Audio from audio clips played through the stage is routed to the internal audio channel. This can be done automatic or manually.

### 12.1.3 DirectShow

#### DirectShow Filters

Viz Engine is able to play any audio file for which a DirectShow filter is installed. DirectShow provides a set of default filters that install automatically with Microsoft Windows. These filters support many data formats while providing a high degree of hardware independence.

All the filters supported by the DirectShow Software Development Kit (SDK) are listed on the Microsoft Developer Network (MSDN) website. If a filter appears in GraphEdit but is not documented by the MSDN on-line reference, it means the filter has either been installed by a third party or is used internally by some other Microsoft technology. Such filters are not supported by the DirectShow SDK.

#### DirectSound Input

Microsoft DirectSound provides a system to capture sounds from input devices and play sounds through various playback devices using advanced 3-dimensional positioning effects, and filters for echo, distortion, reverberation, and other effects.

A DirectSound compatible card is an alternative for designers that use laptops with no video card installed, or if analog audio is needed. Viz supports DirectSound compatible cards that support DirectX version 8 or later.

 **Note:** Matrox are only able to output digital audio.



## DirectSound Audio Card

Viz Engine is able to use any DirectSound capable dual-channel audio card installed in the system.

If a Matrox board is installed on the system, Viz Engine synchronizes the audio output of the DirectSound cards to the video sync signal coming in to the video card.

### **See Also**

- [Channel Setup and Clip Channel Routing](#)
- [Device Recognition and Selection](#)

## 12.2 Device Recognition And Selection

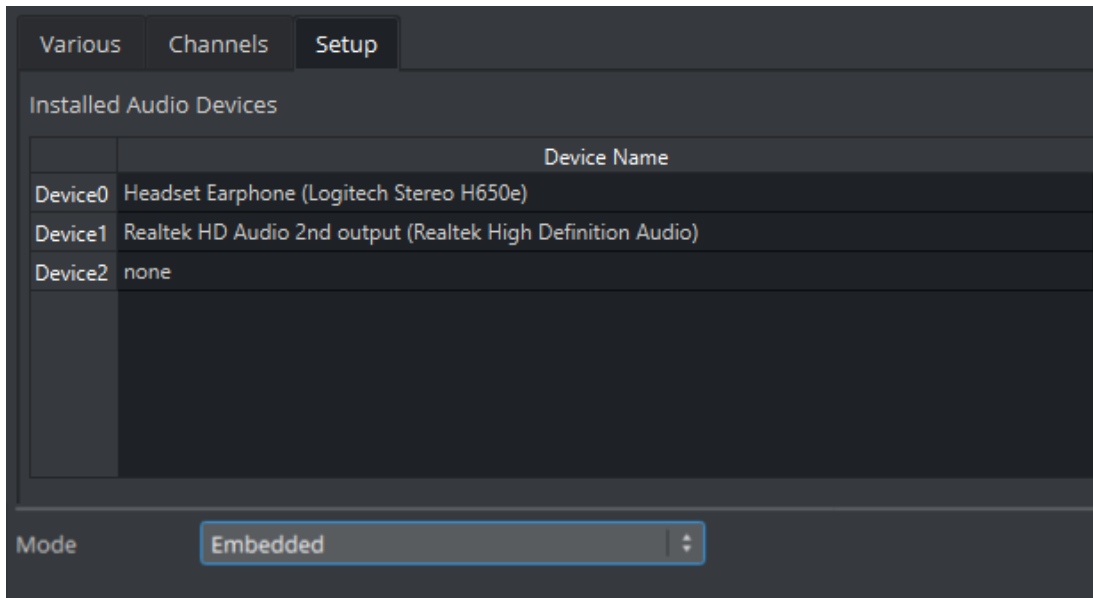

The audio system is able to use any installed DirectSound capable audio device. On every device, up to 16 channels can be used.

- **Mode:** Refers to the audio mode of the Matrox board. Options are:
  - **Embedded:** Captures audio from the Live video input connectors and is made available to the Viz Engine audio mixer, to mix it with other audio sources. Then output as embedded audio on the live video output connectors.
  - **AES:** Captures audio from the AES input connectors and is made available to the Viz Engine audio mixer, to mix it with other audio sources. Then output on the AES output connectors.
  - **Embedded -> AES:** Captures embedded audio from the live video input connectors and is made available to the Viz Engine audio mixer, to mix it with other audio sources. Then output on the AES output connectors.
  - **AES -> Embedded:** Captures audio from the AES input connectors and is made available to the Viz Engine audio mixer, to mix it with other audio sources. Then output as embedded audio on the live video output connectors.
  - **Loop:** Loops audio through. No audio is mixed.
  - **Default:** Captures audio, but no output on the Matrox card.

During the startup process Viz Engine tests all available audio cards installed on the system. Manual activation of audio devices is done in **SECTION AUDIO\_CONFIG** of the Viz Config file. By default a one to one channel assignment from the first audio device is done when a new device is selected.

## 12.3 Timing Behavior And Delay Settings

Timing behavior can only be set for each activated DirectSound. The default values should work for most devices; however, differences may occur between devices.

### 12.3.1 Latency Adjustment on the DirectSound Audio Device

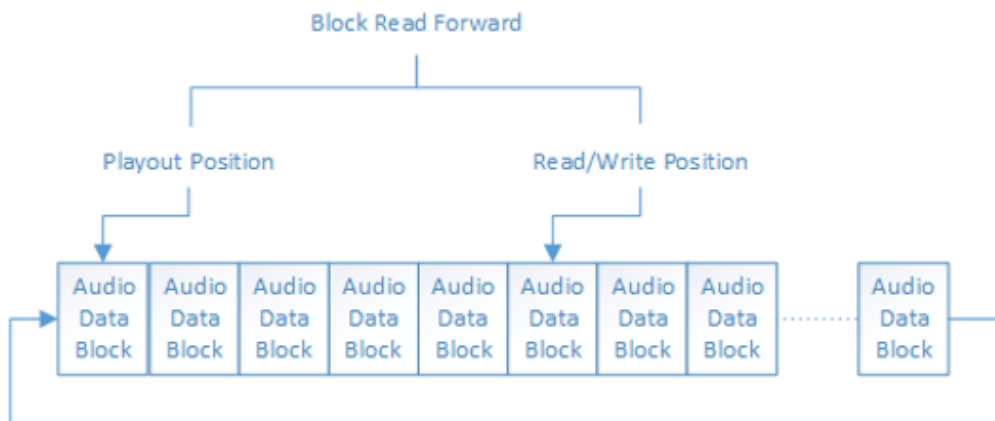

All sound devices use a ringbuffer that stores data until it is sent out to the audio channels, and this ringbuffer is organized in blocks of data. All sound hardware defines a distance in blocks (or bytes) that needs to be maintained. For almost all devices on the market a distance of six blocks is sufficient to have a clean output without artifacts.

✓ **Tip:** Try to decrease the *Block Read Forward* value down to 3 to accomplish less delay for the output. Viz Engine creates a ringbuffer of one second which is split in 60 blocks. This gives an output delay of ten milliseconds when the *BlockReadForward* value is 6 (see the Viz Config file's SECTION AUDIO\_CONFIG).

⚠ **Note:** An audio card which is not synchronized always runs faster or than a synchronized video or audio card. There is a mechanism needed to keep all audio cards synchronized with each other. The mechanism, shown below, is used by Viz Engine to fulfill this condition:

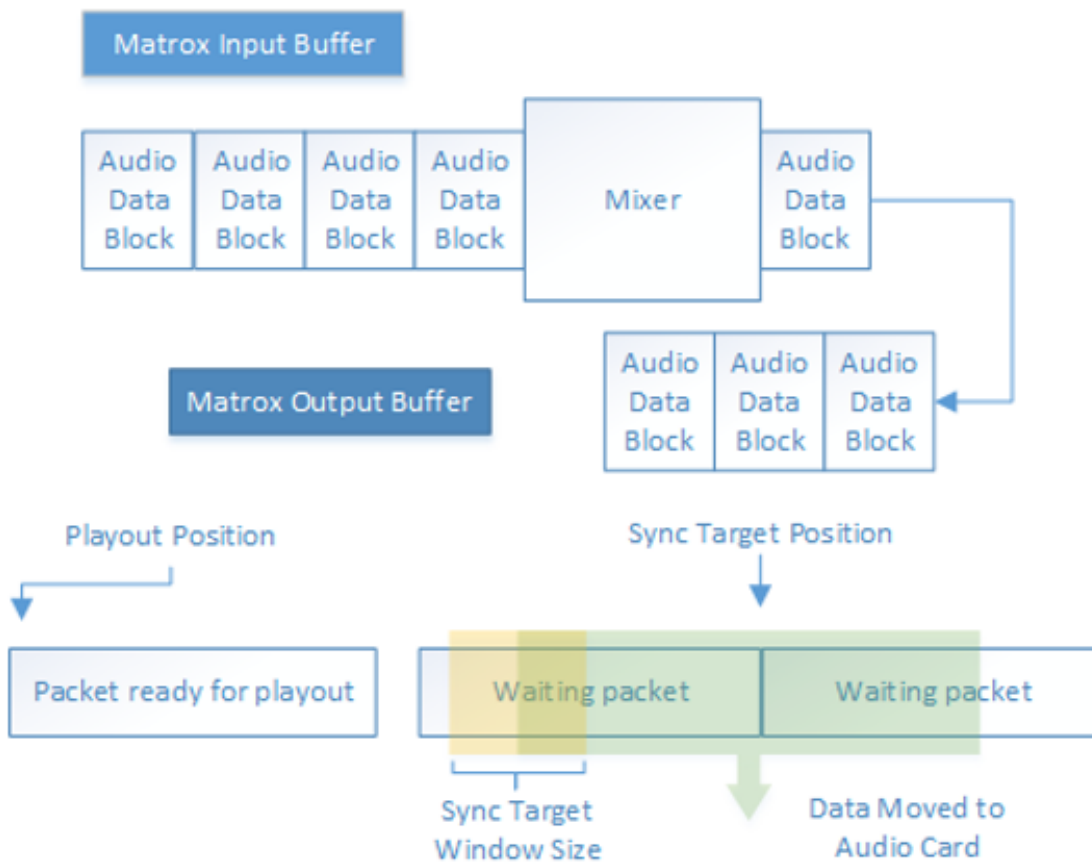

After mixing the packages received from the Matrox board, the blocks of audio data are moved to the Matrox output buffer. This buffer is organized as a ringbuffer and holds one second of data and this is the maximum delay that can be achieved with the described mechanism.

The `SyncTargetPosition` parameter, set in `SECTION AUDIO_CONFIG`, defines the position relative to the playout position of the Matrox board where the audio data for the direct sound cards are branched. If the card is running slower than the reference card, the synchronized position moves away from the playout position. If it is faster, `SyncTargetPosition` moves to the playout position. The `SyncTargetWindowSize` parameter defines the border, when Viz Engine starts to re-sample the DirectSound data to bring `SyncTargetPosition` back in place. The predefined value of 250 samples is a good compromise between performance and quality. If a cheap audio card is used and small artifacts can be heard, try to increase this value. Good ranges are from 250 up to 600.

`SyncTargetPosition` is used to synchronize the different audio cards to each other. Every audio card shows a specific delay behavior. Increase or decrease this value if one card is faster than the other. If the value is too small, artifacts occur; however, most audio cards work fine with the predefined values. `SyncTargetPosition` and `SyncTargetWindowsSize` are configurable settings that can be set separately for every activated audio card.

## Channel Device and Channel Track settings

In Viz Engine, it is possible to combine two or more devices for playout of the Viz Engine's internal audio channels. Note that Viz Engine internally can use up to 16 channels. On many professional multichannel cards the channels are organized in virtual devices with two channels. A good example is the following configuration:

```
Available2 = M-Audio Delta 66 1+2
Available3 = M-Audio Delta 66 3+4
```

In Viz Engine it is possible to combine these two devices and create a quad speaker configuration as shown below:

```
VIZChannelDevice0 = M-Audio Delta 66 1+2
VIZChannelDevice1 = M-Audio Delta 66 1+2
VIZChannelDevice2 = M-Audio Delta 66 3+4
VIZChannelDevice3 = M-Audio Delta 66 3+4
VIZChannelDevice4 = Realtek HD Audio output
VIZChannelDevice5 = Realtek HD Audio output
VIZChannelDevice6 = Realtek HD Audio output
VIZChannelDevice7 = Realtek HD Audio output
VIZChannelDevice8 = none
VIZChannelDevice9 = none
VIZChannelDevice10 = none
VIZChannelDevice11 = none
VIZChannelDevice12 = none
VIZChannelDevice13 = none
VIZChannelDevice14 = none
VIZChannelDevice15 = none
VIZChannelTrack0 = 0
VIZChannelTrack1 = 1
VIZChannelTrack2 = 0
VIZChannelTrack3 = 1
VIZChannelTrack4 = 4
VIZChannelTrack5 = 5
VIZChannelTrack6 = 6
VIZChannelTrack7 = 7
VIZChannelTrack8 = 0
VIZChannelTrack9 = 0
VIZChannelTrack10 = 0
VIZChannelTrack11 = 0
VIZChannelTrack12 = 0
VIZChannelTrack13 = 0
VIZChannelTrack14 = 0
VIZChannelTrack15 = 0
```

### See Also

- The Viz Config file, **SECTION AUDIO\_CONFIG**.

---

## 12.4 Audio Plug-In

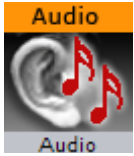

The Audio plug-in allows a designer to configure audio channels.

Go to **Audio** in Container Plugins (see the Container Plugins section of the [Viz Artist User Guide](#)), for more information on the Audio plug-in.

This plug-in is located in Viz Artist (**Built-ins > Container Plugins > Global**) and can be applied to any container.

---

## 12.5 Clip Formats

The recommended audio format is WAVE, as it gives the least decoding time and the best performance. Additionally, it is the only format that matches the Viz Engine support for 16 channels.

Video clips can have interleaved audio in it. The format is limited to 24-bit and 48 khz. There needs to be at least two channels in it, as mono is not supported. Again, the maximum channels are 16.

SDI in, break-out box (BOB) out is supported as well as BOB in and SDI out. It can be controlled by the video/clip channels controls.

Viz Engine is able to import and play the following Formats:

- **WAVE:** Up to 96 kHz, 24-bit and 16 Channels.
- **MP3:** All Formats (Stereo only).
- **OggVorbis:** All Formats, up to 16 Channels.

### See Also

- [Audio Settings](#)
- [Matrox configuration](#)

---

## 12.6 Speaker Names

Viz Engine understands the following default speaker names:

- *FRONT\_LEFT*, *FRONT\_RIGHT* and *FRONT\_CENTER*
- *LOW\_FREQUENCY*
- *BACK\_LEFT*, *BACK\_RIGHT*, and *BACK\_CENTER*
- *FRONT\_LEFT\_OF\_CENTER* and *FRONT\_RIGHT\_OF\_CENTER*
- *SIDE\_LEFT* and *SIDE\_RIGHT*
- *TOP\_CENTER*, *TOP\_FRONT\_LEFT*, *TOP\_FRONT\_CENTER*, *TOP\_FRONT\_RIGHT*, *TOP\_BACK\_LEFT*, *TOP\_BACK\_CENTER* and *TOP\_BACK\_RIGHT*
- *SPEAKER\_RESERVED*

### See Also

- [Audio Settings](#)
- [Matrox](#) configuration interface



---

## 12.7 Emergency Alert System

The Emergency Alert System (EAS) is a national warning system used in the United States that supersedes the Emergency Broadcast System (EBS) and the CONELRAD System. EAS is jointly coordinated by the Federal Communications Commission (FCC), Federal Emergency Management Agency (FEMA) and the National Weather Service (NWS). The official EAS is designed to enable the President of the United States to speak to the citizens of the United States within ten minutes.

In Viz Engine, the analog audio input through the DirectSound device is reserved for the Emergency Alert System (EAS) for broadcasters in the United States of America. If the EAS is activated, all audio is muted, and the source from the first analog audio card installed in the system is played through the [Matrox](#) board. The behavior is supported with the Text-to-Speech plug-in, as well as audio clips which are recorded prior to sending. These clips can be added dynamically. Viz Engine then adds them directly into predefined audio channels and also mute the other channels.

### 12.7.1 To Specify Output Channels for EAS

1. Open [Audio Settings](#) and select the **Channels** tab.
2. In the **Out Channel** list, enter the keywords `EAS0` and `EAS1` for the left and right channels, respectively. If either keyword is used in any channel, explicit mapping is used.

Several output channels may be pointed to by the same EAS channel. If no explicit mapping is set, Viz Engine defaults to output channels zero and one. Empty mapping is not allowed for the EAS system.

## 12.8 Shared Memory Integration Of Channel Volume Levels

The volume level of Live Input Channels like SDI, IP or NDI as well as clip channels can be exposed to a Shared Memory Variable. This could be used, for example, to visualize a level meter of an input source.

Any change to the input level is written into a shared memory variable in the System.Map. The naming convention is the following:

- *AudioLevel.LiveIn0\_0* for the **first Live Input** and the **first channel**.
- *AudioLevel.LiveIn0\_1* for the **first Live Input** and the **second channel**.
- *AudioLevel.LiveIn1\_0* for the **second Live Input** and the **first channel**.
- *AudioLevel.LiveIn1\_1* for the **second Live Input** and the **second channel**.
- *AudioLevel.LiveIn5\_63* for the **sixth Live Input** and the **sixty fourth channel**.
- *AudioLevel.ClipIn0\_0* for the **first Clip** and the **first channel**.
- etc....

To specify how often these values are updated, you can either specify a fixed value in the Viz configuration file:

```
#####
SECTION AUDIO_CONFIG
#####

## 0: No calculation of VU meter values at all (default), > 0: frequency of frames
when calculation happens (every X frame(s)).
AudioLevelMeterUpdateInterval = 2
```

or you can send a command to change it during runtime:

```
MAIN*CONFIGURATION*AUDIO*LEVEL_METER_UPDATE_INTERVAL GET / SET
```

 **Information:** A setting of 0 means to not send values anymore.

 **Note:** That the value you receive is in decibel, which is a logarithmic value between -0 and -120.

A sample script to generate a volume meter:

```
dim mySrc as string
Sub OnSharedMemoryVariableChanged(map As SharedMemory, mapKey As String)
    dim tmp as array[string]
    dim normal_val as double
    If mapKey.StartsWith("AudioLevel") Then
        dim val = Cdbl(map[mapKey])
        normal_val = calculate(val)
        mapKey.Split("_",tmp)
        dim idx = cInt(tmp[-1])
```

```

    if ChildContainerCount >= idx then
        GetChildContainerByIndex(idx).scaling.y = normal_val
    end If
End If
End Sub

function calculate(db as double) as double
    dim myval as double
    calculate = 10 ^ (db/20.00)
end function

sub OnInitParameters()
    RegisterParameterString("source","Source","LIVE1",20,20,"")
end sub

Sub OnParameterChanged(parameterName As String)
    if parameterName = "source" Then
        if mySrc<>" Then
            system.map.UnregisterChangedCallback("AudioLevel."&mySrc&"_0")
            system.map.UnregisterChangedCallback("AudioLevel."&mySrc&"_1")
        end If
        mySrc = GetParameterString("source")
        system.map.RegisterChangedCallback("AudioLevel."&mySrc&"_0")
        system.map.RegisterChangedCallback("AudioLevel."&mySrc&"_1")
    end If
end Sub

```

This script generates an input field, that specifies the source (for example, ClipIn0). Any change in the shared memory map for AudioLevel.Clip0\_0 or AudioLevel.Clip0\_1 (Stereo) is applied to y-scaling of two subcontainers:

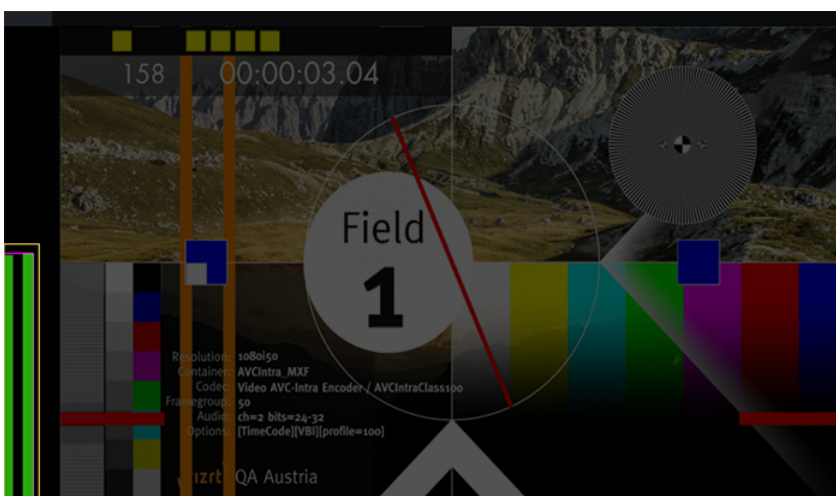
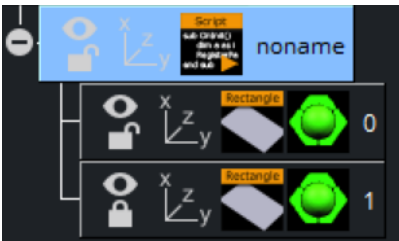

## 12.9 Dolby E Configuration

**✘ Important:** Currently there is no verified Dolby E support in Viz Engine.

This section explains how to consistently set up a Viz Engine for use with the DolbyE audio codec.

- [Enable DolbyE](#)
- [Prepare for DolbyE Decoding](#)
- [Prepare for DolbyE Encoding](#)
- [Decode Plus Encode](#)
- [Pass-through Mode](#)

**⚠ Note:** We use zero-based channel numbering in this configuration (channels zero through 15).

One most important prerequisite is a dongle containing a license from Minnetonka, the firm which makes the Surcode encoder/decoder SDK. You must have audio setup for 16-channel embedded mode in Viz. The inputs containing a DolbyE stream should also be configured for 16-channel, or at least 8-channel, depending on how many other audio channels are in the SDI audio track.

### 12.9.1 Enable DolbyE

There is one global flag for this in the Viz config file, this must be set for decoding or encoding.

```
DolbyEEnabled = 1
```

### 12.9.2 Prepare for DolbyE Decoding

DolbyE uses two audio channels on input. These channels must be a contiguous pair (i.e. 0/1, 2/3, 4/5, or 6/7). On the transmit side SDI audio does work mainly with audio pairs, as well as groups.

The decoded data is always eight channels, and is always written to the upper eight channels, eight through 15.

You must specify two pieces of information:

- The video channel (which live input to use).
- The first audio channel in the pair.

For the first:

```
ChannelDolbyEnabled__0 = 1 // video live input 1 contains the DolbyE data, or
ChannelDolbyEnabled__3 = 1 // video live input 4 contains the DolbyE data
```

For the second, you specify the first channel in an audio pair:

```
ChannelDolbyPos__1 = 4 // video live input 2 contains the DolbyE data on channels 4/5
```

The channels containing the DolbyE stream are muted on output. For example, if your input consists of PCM audio on channels 0-5, and DolbyE data on channel 6-7, you get 14 channels of audio on output (given no other audio routing settings):

```
0 = input 0
1 = input 1
2 = input 2
3 = input 3
4 = input 4
5 = input 5
6 = silence - dolby data is muted
7 = silence - dolby data is muted
8 = decoded 0
9 = decoded 1
10 = decoded 2
11 = decoded 3
12 = decoded 4
13 = decoded 5
14 = decoded 6
15 = decoded 7
```

### 12.9.3 Prepare for DolbyE Encoding

In this case, we go from eight channels of PCM audio to two channels for the DolbyE stream. For input to the Dolby code, you can choose from two banks of eight channels: the lower eight (zero through seven) or the upper eight (eight through 15). The config field:

```
DolbyEOutput = 0 // No encoding
DolbyEOutput = 1 // Encode the lower eight, 0..7
DolbyEOutput = 2 // Encode the upper eight, 8..15
```

For output, you must give the first audio channel in a pair, which contains the DolbyE stream, for example:

```
DolbyEMixInPosition = 4 // goes out on channels 4/5
```

### 12.9.4 Decode Plus Encode

It is possible to perform a scenario which uses both encoding and decoding.

### 12.9.5 Pass-through Mode

There are settings which enables a DolbyE data stream to go through the Viz audio mixer untouched. Normally, if you send integer data through the mixer, the bits are changed on output, as the mixer uses floating point math, with a conversion on input and output. This renders the DolbyE stream unusable. The DolbyE data goes through the audio mixer unconverted to floating point along the way.

```
ChannelDolbyEEnabled__0 = 1
ChannelDolbyEPos__0 = 0
ChannelDolbyEEnabled__1 = 1
ChannelDolbyEPos__1 = 2
ChannelDolbyEEnabled__2 = 1
ChannelDolbyEPos__2 = 4
ChannelDolbyEEnabled__3 = 1
ChannelDolbyEPos__3 = 6
ChannelDolbyEEnabled__4 = 1
ChannelDolbyEPos__4 = 8
ChannelDolbyEEnabled__5 = 1
ChannelDolbyEPos__5 = 10
ChannelDolbyEEnabled__6 = 1
ChannelDolbyEPos__6 = 12
ChannelDolbyEEnabled__7 = 1
ChannelDolbyEPos__7 = 14
DolbyEOutput = 0
DolbyEEnabled = 1
DolbyEMixInPosition = 0
DolbyELoop = 1
```

 **Note:** For a simple pass-through no Dolby dongle is required.

## 12.10 Channel Setup And Clip Channel Routing

Channel setup is configured in the [Audio Settings](#) section in Viz Configuration. To get a correct mixing of clip channels, to the Viz Engine internal channels it is important to set the audio channels in a correct way.

The [Audio Settings](#) section of Viz Configuration is used to configure audio channels and channel routing, and [To Add Multi-language Audio Channels](#). The latter allows the same scene with the same audio clips to output English, German, French and background music on three different machines. It is also possible to create 3D and other channel configurations for as many environments as needed. Stereo is configured by default.

From Viz Artist, a scene designer is able [To Add Multiple Audio Channel Configurations](#), test the audio channel setup, and switch between the different local setups matching for example one or several remote Viz Engine audio setups. Configurations can also be tested separately or all together.

### 12.10.1 To Test Audio Channel Setup

1. Start Viz Artist.
2. Create a new Scene.
3. Add a group container to the Scene Tree.
4. Add the [Audio Plug-in](#).
5. Open the Audio plug-in editor.
6. Add an audio clip to the *Test Clip* drop-zone.
7. Click **Play**.

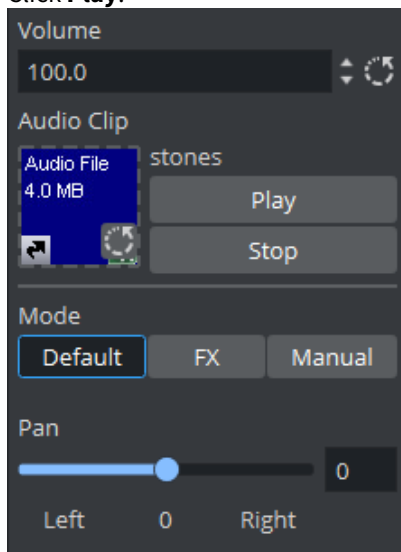

**Tip:** Always have a set of test clips that provide audio for the different channel setups.

---

## 12.11 Matrox Audio

The Matrox card is able to use up to 16 channels for capture and playout. The audio can be embedded into the video signal or be an external signal through the AES/EBU connectors. The available AES/EBU connectors depend on the Matrox version.

On the X.mio cards, there are balanced 75 Ohm connectors.

### 12.11.1 To Enable Matrox Audio

1. Open **Viz Config**.
2. Click on [Audio Settings](#).
3. In the **Various** tab, Enable Audio Active. This must be done for AES/EBU audio as well.
4. Click on the **Setup** tab.
5. Set a **Mode**. Select from:
  - Embedded
  - AES
  - Embedded AES
  - AES Embedded
  - Loop
6. Click on **Matrox**.
7. Select **VideoIn A** or **VideoIn B**.
8. In the **Audio** section:
  - Set **Audio** to **Active**.
  - Set the required **Channels**.
  - Set the required **Delay**.
9. Click **Save**.
10. Close **Viz Config**.



**Tip:** Use the provided configuration templates for a proper Audio Video delay. These templates are stored in **C:\Program Files\Vizrt\Viz3\Configuration Profiles**, you can easily access them by clicking on **Load** and **Installed Profile**.



---

## 13 Viz Engine Shared Memory

A local `VizCommunication.Map` in each Viz Engine (as part of a cluster), collects and stores data. This data can be internal data, like a scene script pushing data to the map, or data from external control applications through TCP or UDP.

This section contains information on the following topics:

- [Viz Engine SHM Synchronization](#)
- [Viz Engine SHM External Data Input](#)
- [Viz Engine Internal Data Interactive Scene](#)
- [Viz Engine SHM Snapshot](#)

### See Also

- [Data Sharing](#) (see the [Viz Artist User Guide](#))

## 13.1 Viz Engine SHM Synchronization

If a Viz Engine is restarted or added to the cluster of Viz Engines for playout, the *VizCommunication.Map* data is not available on this Viz Engine. The local map on a new or restarted Viz Engine can be synchronized with the local map on another running Viz Engine in the same cluster.

A start-up Viz Engine can be synchronized through:

- TCP
- UDP
- An External Control Application
- Commands

**Example:** If Viz Engine 1 restarts it looks to Viz Engine 3 to update its local *VizCommunication.Map*.

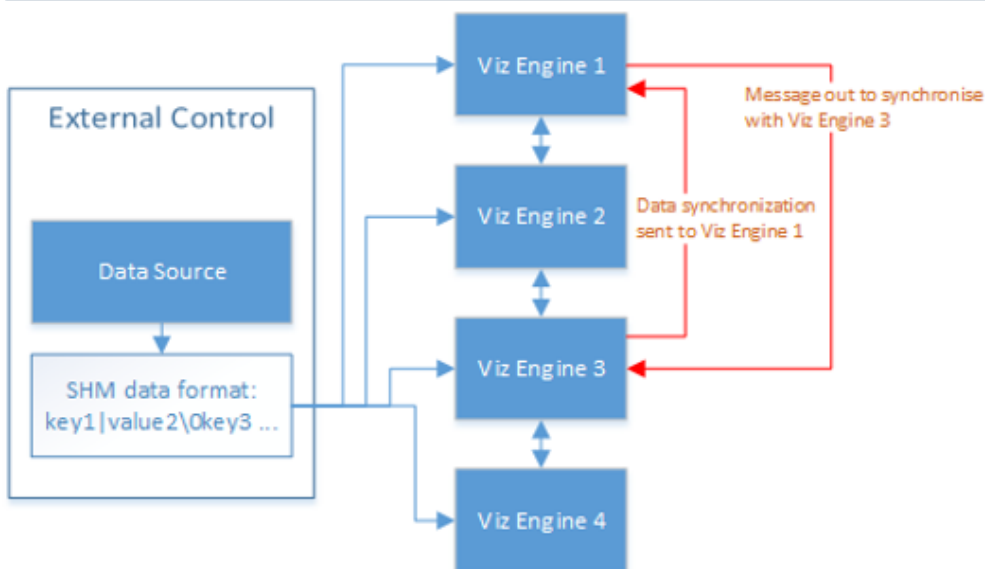

This section contains information on the following topics:

- TCP and UDP Synchronization
  - To Synchronize a Viz Engine with TCP or UDP
- External Control Synchronization
  - From a Command Interface
  - Through TCP Communication
  - Through UDP Communication
- Command Synchronization
  - To Synchronize a Start-up Viz Engine with Commands

### 13.1.1 TCP and UDP Synchronization

Use the procedure detailed below to synchronize a restarted or added Viz Engines, in a cluster, with the TCP or UDP protocol:

- **TCP:** The recommended communication protocol to synchronize maps on start-up because it is reliable and efficient (see [SHM over TCP](#)).
- **UDP:** For fast communication, but has drawbacks. For instance, packets can get lost (see [SHM over UDP](#)).

### To Synchronize a Viz Engine with TCP or UDP

Multicast IP Address	224.2.2.2
Multicast Port	0
Udp Port	7101
Tcp Port	7102
Debug	Off
Master Engine IP Address	127.0.0.1
Master Engine Port	6100
Master Poll	<input type="button" value="Inactive"/> <input type="button" value="Commands"/> <input type="button" value="UDP"/> <input checked="" type="button" value="TCP"/>

1. Go to [Viz Configuration](#).
2. Click on [Communication](#).
3. Click on the **Shared Memory Properties** tab.
4. Enter the TCP or UDP port number.

**Note:** Always make sure that the selected port number is not in use by any other program on the same subnet. This is important for systems running multiple instances of Viz Engine.

5. In **Master Engine IP Address**, type the IP address of a running Viz Engine to synchronize with. Example *<IP/hostname of Viz Engine 3>*.

**Note:** Must be the IP address of a running Viz Engine in the same cluster system.

6. In **Master Engine Port**, type the port number to be used (default 6100). This port sends the single startup synchronization command to start synchronizing. It should be the same as the general communication port of the Viz Engine set in **Master Engine IP Address**.
7. In **Master Poll**, select **UDP** or **TCP** as selected in step 4.
8. Click **Save**.

### 13.1.2 External Control Synchronization

Synchronization can also be done from an External Control Application. The following command has to be sent to the Viz Engine which has the memory map populated:

## From a Command Interface

```
VIZ_COMMUNICATION SYNCHRONIZE_TO <engine port>
```

where the Viz Engine is the engine which receives the data through the Command Interface. The port is usually `6100` (standard command interface port).

 **Note:** This is not recommended as a method for synchronization.

## Through TCP Communication

```
VIZ_COMMUNICATION SYNCHRONIZE_SMMTCP <engine port>
```

where the Viz Engine is the engine which receives the data, and the port is the one that was specified for incoming TCP key/value pairs on the Viz Engine which is to receive the data (see [SHM over TCP](#)).

## Through UDP Communication

```
VIZ_COMMUNICATION SYNCHRONIZE_UDP <engine port>
```

where the Viz Engine is the engine which receives the data, and the port is the one that was specified for incoming UDP key/value pairs on the Viz Engine which is to receive the data (see [SHM over UDP](#)).

### 13.1.3 Command Synchronization

Another communication option is by Commands. Here each map entry is synchronized through commands. It is reliable, but very slow and blocks the engine for quite an amount of time, if the map is large.

 **Note:** This is not recommended as a method for synchronization.

## To Synchronize a Start-up Viz Engine with Commands

1. Go to [Viz Configuration](#).
2. Click on [Communication](#).
3. Click on the **Shared Memory Properties** tab.
4. In the Shared Memory panel set these parameters:
  - **Master Engine Port:** Enter the communication port of the primary Engine (default is `6100`).
  - **Master Poll:** Click on **Commands**.
5. Click **Save**.

## 13.2 Viz Engine SHM External Data Input

Data fed into the Shared Memory (SHM) should be done through the dedicated UDP or TCP IP ports for the SHM. Vizrt provides a set of components, *SendToSMM*, to make this task easier.

**Note:** Go to <Viz Install Directory> > Tools > SendToSMM, for more information about SendToSMM.

Data can also be sent to SHM through a Command Interface. Data sent through the Command Interface may be seen as a good option because the data would need to be sent to one Viz Engine only, and this Viz Engine engine would then distribute the data to the other Viz Engines. But data sent to SHM through the Command Interface has problems:

- Data sent through the Command Interface blocks the render queue of the receiving engine causing potential frame drops. Since the data needs to be sent through a command significant more bytes are transferred over the network.
- This Viz Engine is also a single point of failure.
- The data arrives at this one Viz Engine sooner than on all other Viz Engines.
- The notification method of the Graphic Hub is used to distribute the data and can cause additional load for the Graphic Hub.

The preferred method to send data is to use the *SendToSMM* library (or an equivalent) to send the data to the individual Viz Engines.

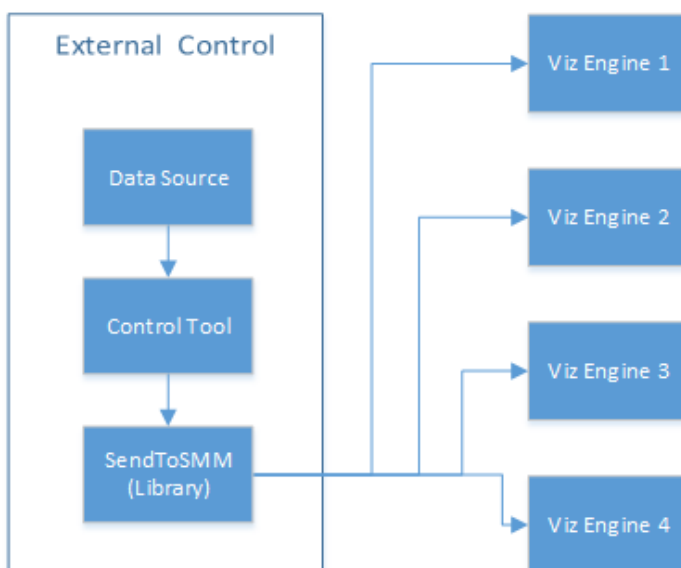

The communication protocol for the import of Shared Memory data depends on the type and final output of the data. There are set protocols to use with large amounts of data, in which all of the data must reach its destination graphic, and also where large amounts of data must be received quickly, but some loss of data is acceptable.

**Note:** It is also possible to import data through Multicast. This method is not recommended as it can pollute the network.

This page contains information on the following:

- [SHM over TCP](#)
  - [To Use TCP for SHM](#)
- [SHM over UDP](#)
  - [To Use UDP for SHM](#)
- [Plug-in API](#)
  - [Command Interface](#)
  - [Command Examples](#)

### 13.2.1 SHM over TCP

The SHM TCP communication protocol guarantees a reliable delivery of packages. It is a much more efficient than the [Command Interface](#), but not as fast as [SHM over UDP](#).

Use cases for a TCP connection could be finance stocks and currencies, or election result information, where the requirement is to deal with large amounts of information, and all of this data must reach its destination graphic. A single piece of lost data can have economic consequences, falsify charts, show mathematically wrong results, etc.

A TCP connection to a Viz Engine can be held open for a long time (this is recommended), and should not be closed and reopened between sending variables.

**Note:** The default number of connections is `1` and the maximum number of TCP Shared Memory connections is limited to `255`. Within this number of connections, a user-defined limit of maximum connections can be set in the configuration file with `smm_thread_count`.

**IMPORTANT!** The external program which provides the data, must connect and send the data to each Viz Engine individually. Vizrt provides a C# library, `SendToSMM` (part of the Viz install), for this purpose.

#### To Use TCP for SHM

Multicast IP Address	224.2.2.2
Multicast Port	0
Udp Port	0
Tcp Port	7102
Debug	Off
Master Engine IP Address	127.0.0.1
Master Engine Port	6100
Master Poll	<input type="button" value="Inactive"/> <input type="button" value="Commands"/> <input type="button" value="UDP"/> <input checked="" type="button" value="TCP"/>

1. Go to the [Configuring Viz](#).
2. Click on [Communication](#).
3. Click on the **Shared Memory Properties** tab.
4. In the Shared Memory Panel, set **TCP Port**. There is no specific recommended port. Always make sure that the selected port is not in use by any other program on the same subnet.
5. Click **Save**.

The syntax for the key-value pairs is:

- key|value\0

Multiple key-value pairs can be sent, at once, as well. To do this make sure that each pair is terminated with `\0`.

- key1|value1\0key2|value2\0key...

### 13.2.2 SHM over UDP

The SHM UDP communication protocol should be used for the delivery of volatile data. It is quicker than the [SHM over TCP](#) protocol, but less reliable, and is much more efficient than the [Command Interface](#).

A use case for UDP would be Motor Sports, where data like speed, velocity, etc., is required. This is where there is a requirement to deal with large amounts of data, but not all of this data must reach its destination. A single piece of lost data does not affect the constant data update.

#### To Use UDP for SHM

Multicast IP Address	224.2.2.2
Multicast Port	0
Udp Port	7101
Tcp Port	0
Debug	Off
Master Engine IP Address	127.0.0.1
Master Engine Port	6100
Master Poll	<input type="radio"/> Inactive <input type="radio"/> Commands <input checked="" type="radio"/> UDP <input type="radio"/> TCP

1. Go to the [Configuring Viz](#).
2. Click on [Communication](#).
3. Click on the **Shared Memory Properties** tab.
4. In the Shared Memory Panel, set **UDP Port**. There is no specific recommended port. Always make sure that the selected port is not in use by any other program on the same subnet.
5. Click **Save**.

The syntax for sending key-value pairs is the same as for [TCP and UDP Synchronization](#).

### 13.2.3 Plug-in API

An option to manipulate data in SHM is by a plug-in interface. A use case would be where a TCP or UDP connection can not be used, or is not to be used. It is possible to write a plug-in to import data (for example, from an XML file, another database, etc.) and push it to SHM.

Another use case would be an interactive Scene (see [Viz Engine Internal Data Interactive Scene](#)).

**Note:** The Plug-in API documentation is included with the Viz installation (go to **Start > All Programs > Viz Artist x.x > Plugin SDK Documentation > Classes > Class List > SHARED\_MEMORY**).

### Command Interface

For small and single value changes the Command Interface of Viz Engine can be used. For example, to update a headline in a Scene.

**IMPORTANT!** A command operation can block the renderer. If there are too many commands, within a small time, or commands containing a large amount of data, are sent, this can result in not rendering real-time anymore.

**Note:** Vizrt do not recommend this as a method for data import.

Any external program should consider the performance of the single or all connected Viz Engines. If there is a burst of thousands of SHM variables this can have implications on the Viz Engine rendering performance (Current (CUR) and Maximum (MAX)). A full list of commands is located at `<viz install folder>\Documentation\CommandInterface\index.html`

**Note:** From the list of commands, the commands, `CLEAR`, `DELETE_ELEMENT` and `PURGE_ELEMENT` only works when sent through the command interface of Viz Engine.

**IMPORTANT!** The command `CLEAR` must be run on each Engine where the MAP is to be reset (`VIZ_COMMUNICATION*MAP CLEAR`).

Whenever a new entry is made in the map (a new key-value pair) or values are changed, then the change is propagated to the other Viz Engines through a database messaging service to update the local copy of each Viz Engine's map (this only works when sent over the general communication port of Viz Engine. The default port is `6100`).

### Command Examples

`VIZ_COMMUNICATION*MAP` can be used to access the map.

`SET_DOUBLE_ELEMENT` and `GET_DOUBLE_ELEMENT`



 **Example:** `VIZ_COMMUNICATION*MAP SET_DOUBLE_ELEMENT "my_double" 1.2`

 **Example:** `VIZ_COMMUNICATION*MAP GET_DOUBLE_ELEMENT "my_double"`

---

## 13.3 Viz Engine Internal Data Interactive Scene

When data is modified on the distributed shared memory map on one Viz Engine through a script or through a plugin, the data change gets reflected on the other Viz Engines automatically if they are configured to listen to the same shared memory map key. A use case could be a touch screen scene which modifies data, which is also used for HD-SDI Viz Engines or Viz Engines driving a Video Wall.

This synchronization uses Graphic Hub as a relay. Therefore, it is important that all Viz Engines which are to receive the data are connected to the same Graphic Hub, which use the same user or at least the same group.

### 13.3.1 Example

```
sub onInit()  
VizCommunication.Map.RegisterChangedCallback("game")  
end sub  
  
sub OnSharedMemoryVariableChanged(map As SharedMemory, mapKey As String)  
if mapKey="game" then  
dim val = VizCommunication.map["game"]  
println "new value:"+val  
end if  
end sub
```

If you now change the value of "game" on any of the connected clients running a scene with the above script, all engines should print the new value into the console window.

---

## 13.4 Viz Engine SHM Snapshot

It is also possible to take a data snapshot (save the whole content of the map) at any time. One Viz Engine can save the whole content of the map by calling the map's *SaveToDb* procedure, and another client can read it by calling *LoadFromDb*. The downside of this approach is that these functions block the renderer and can cause poor performance of the Graphic Hub Manager database, if the map is stored repeatedly.

 **IMPORTANT!** The resulting SHM map objects are replicated as well. So saving the map each field or every minute can result in serious problems for the Graphic Hub Manager database (replication failing, etc.).

 **Note:** For more information see the script function documentation. Go to, **Start > All Programs > Viz Artist x.x > Script Documentation > Data Types and procedures > Shared Memory**, or **<Viz Install Directory> > ScriptDoc > DataTypeSharedMemory**.

### See Also

- [Viz Engine SHM External Data Input](#)
- [Viz Engine SHM Synchronization](#)

---

## 14 Video Wall Configuration

Viz Engine supports output to multiple monitors configured as one large screen, commonly referred to as a video wall. This section details the hardware and software requirements, and how to configure Viz Engine to use a Video Wall.

Viz Engine video walls are based on the NVIDIA Mosaic technology for multiple displays, in an array of configurations. This allows for resolutions as high as up to 16k by 16k from one Engine, fully synchronized with the house sync signal, with displays in landscape, portrait or arbitrary rotation layouts at the same time.

Please take a look at the [Troubleshooting](#) section prior to setting up NVIDIA Mosaic for the first time, as it provides solutions for common issues that may arise during Mosaic setup.

This chapter contains information on the following topics:

- [Hardware Requirements and Recommendations](#)
- [Performance Considerations](#)
- [Troubleshooting Video Wall Configurations](#)
- [HDR Window Configuration](#)
- [Video Wall Setup Instructions](#)

---

## 14.1 Hardware Requirements And Recommendations

This section has information on the following topics:

- [Minimum Hardware Configuration for Video Walls](#)
- [Recommended Configuration for Video Walls](#)
- [UHD Configuration with X.mio5 Boards](#)
- [IP-based Video Walls](#)

The decision about which hardware to use when setting up a video wall depends a great deal on how the video wall can be used. In the most basic sense, any multi-display setup can be used. However, when in need of an increased number of displays, clip playback capabilities, live streams, or complex graphics, the demands on the hardware increases significantly. A video board is required for clip playback and input capabilities.

Utilizing the NVIDIA Quadro P6000 graphics cards and the Matrox X.mio3 video board, Viz Engine support video wall configurations with up to 16k by 16k output resolution, and up to eight SDI inputs. Depending on the selected configuration, Viz Engine currently supports the following inputs and outputs for video walls:

- Four to eight SDI inputs, with resolutions ranging from SD to UHD, with a maximum of eight 1080i or one UHD concurrent input. (X.mio3).
- Up to six UHD inputs on X.mio5 SDI (and Gen-4 PCI).
- Four to 16 DisplayPort or DVI outputs, with up to UHD resolution per output.

 **Note:** More GPUs require more bandwidth and therefore decrease the performance. Therefore, it is strongly recommended to use only one physical GPU and split the outputs (4\*5K on P6000) with additional hardware like a Datapath Device.

### 14.1.1 Minimum Hardware Configuration for Video Walls

- HP Z8-series Desktop Workstation
- NVIDIA Quadro P6000 graphics card
- Matrox X.mio3 video board or Matrox DSX LE4 video board
- NVIDIA Quadro Sync synchronization card

### 14.1.2 Recommended Configuration for Video Walls

- Lenovo P620 Desktop Workstation
- NVIDIA Quadro A5000 graphics card
- Matrox X.mio3/DSX LE4 or X.mio5 SDI video board
- NVIDIA Quadro Sync synchronization card

 **Note:** Videowall configurations require a DVI Max Resolution license.

### 14.1.3 UHD Configuration with X.mio5 Boards

With the high bandwidth required to transform UHD surfaces to the GPU, any system that requires more than three UHD surfaces (no matter if live or clip) needs to be a **Gen-4 PCI** equipped system (like a Lenovo P620 and a Gen-4 GPU, or like an A5000 or A6000). This guarantees playback of eight UHD surfaces (live or clips).

### 14.1.4 IP-based Video Walls

X.mio5 based topology boards do not have a genlock connector anymore, they only synced using PTP (older X.mio3 IP boards still have a Genlock connector). To correctly synchronize a videowall using X.mio5 boards, you need:

- A valid PTP signal.
- A blackburst signal to synchronize the NVIDIA gSync board.
- A blackburst signal for any additional device (for example, Signal processors or the displays).

All of these signals need to be driven from the same source. Therefore, it is highly recommended to use a system generating PTP and Genlock sources from the same clock.

The following diagram illustrates a basic synchronization flow:

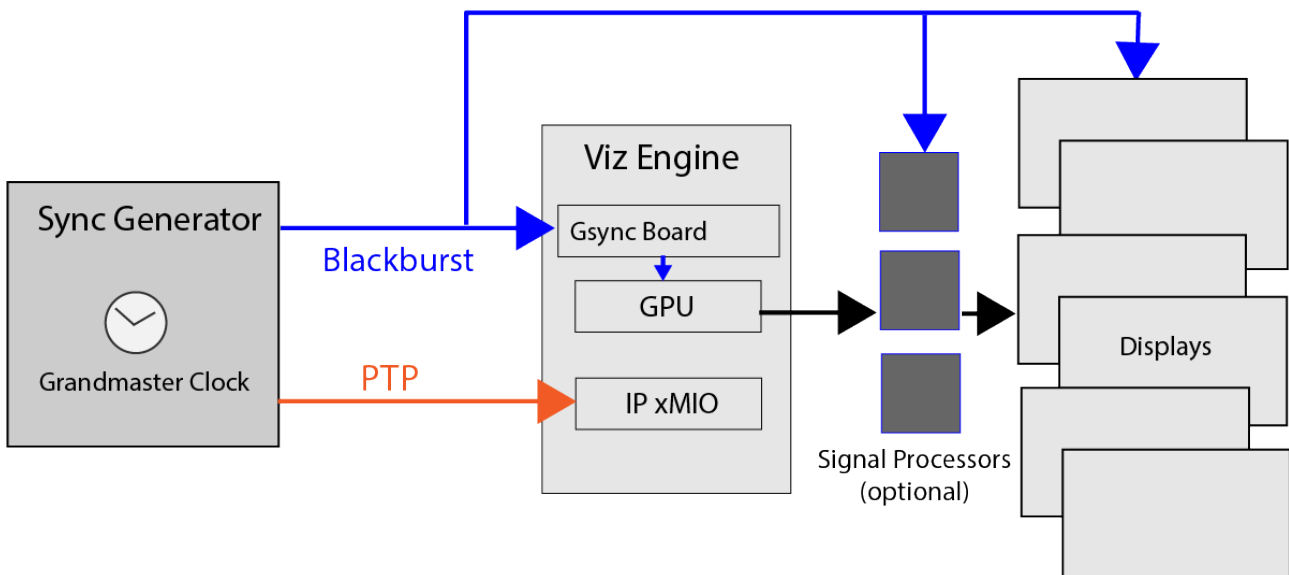

---

## 14.2 Performance Considerations

For maximum performance, the hardware described in the Recommended Configuration for Video Walls section should be used. In addition, Viz Engine should be running without GUI. To do this, start Viz Engine with the following command line options: `<viz install folder>\viz.exe -n -w`

### 14.2.1 Hardware Considerations

As Viz Engine operates in real time, rendering the output field by field, a wide range of factors may influence performance. Each field is rendered within 20 or 16.67 milliseconds, depending on the output format being 50 Hz (PAL) or 59.94 Hz (NTSC), respectively. This means that any requirements added to the render process reduces the time available for rendering the final output. Such requirements can be, but are not limited to:

- Copying between GPUs on a multi-GPU system.
- Copying between CPUs on a multi-CPU system.
- The system bus transfer rate on the system's motherboard.
- The amount of data to be copied and finally rendered.

In other words, adding more GPUs to the system decreases the overall performance, because of the time required for copying information between the GPUs. In configurations with multiple graphics cards, the cards should be connected to the same CPU (refer to the motherboard specifications). As a result, single GPU setups are *always* recommended over multi-GPU setups for performance reasons. By adding the [Datapath Fx4](#) display wall controller, a 4K signal can be split into four HD signals. This allows to run, for example, a video wall with a total of 16 displays on one P6000 graphics card, with four Datapath Fx4 units.

On a multi-CPU system with two graphics cards, assigning them both to the same CPU can increase performance with as much as 30 percent.

### 14.2.2 Clip Playback

Utilizing several clip channels, either as insert or as backdrop is one of the main purposes of a videowall. The following points are important if one wants to playback clips without any jittering or stuttering on videowalls:

- Each clip channel requires several resources like buffers, codec initialization, file handles etc. Please activate only the required amount of clip players going to be used.
- Clips do have a pending player in background, meaning a clip is loaded into the pending player and when ready, it becomes the active player. This is not required anymore when using Super Channels, please deactivate the pending clip player.
- To avoid jittering when going On Air, use a warmup scene to utilize the clip channels. This warmup scene should have all required clip channels available as textures.
- The warmup scene should load a clip into its clip channels. This ensures all buffers are prepared and filled up. The codec of the clip should match the codec used later on (switching to a different codec should not affect the clip player).

**Information:** You can use the flag `Matrox.Clip.DelayedInitialization = 0`, to make sure all clip channels are initialized on Viz Engine startup. The loading of clips is still required by the warmup scene. This increases your startup and shutdown time! This also showed improved performance to the initial playout of clips in Videowall setups with multiple clip channels enabled.

- Playback of AVC/h264 UHD clips requires an installed M264 board. Any other UHD clip playback requires a strong multicore CPU.

### 14.2.3 Scene Design Considerations

When designing scenes for a video wall, the design and graphics should be tested on the actual video wall. The scenes can be tested on computer monitors as well, in which case the monitor layout should preferably be as close to that of the video wall the scenes are being designed for, even down to make and model. This is to avoid different configurations, as well as the look and feel of the test configuration.

For the best result, performance tests should always be performed on the actual video wall before taking a new scene On Air.

Super Channels should be used as replacement of GFX Channels.

Since Viz Artist 3.8.2, the resolution of GFX Channels is by default set to the configured output resolution. To increase performance, limit the GFX channel resolution to the maximum resolution needed, for example 1920 x 1080 for HD resolution. The resolution setting depends on the scenes to be shown and how memory intensive they are.

In Multi-GPU configurations, GFX Channels should be added as Texture rather than DVE assets, as the performance improves significantly.



## 14.3 Troubleshooting Video Wall Configurations

Please take a look at this section prior to configuring a Video Wall for the first time. It provides solutions for common issues which may arise during setup, and covers the following topics:

- [Performance Issues](#)
- [Steps to Recover from Severe NVIDIA Mosaic Driver Related Issues](#)
- [Experiencing BSOD or System Freeze while Setting up Mosaic](#)
- [Only Some Displays of the Video Wall display an Image](#)
- [Missing NVIDIA Control Panel Settings](#)
- [NVIDIA Control Panel Crashes](#)
- [Mosaic Configuration Not Supported Error](#)
- [G-Sync Status LEDs or Topology Reports Indicate a Synchronization Issue](#)
- [Poor Performance when Using GFX Channels as DVE](#)
- [Jittering on HP Z840](#)
- [Other Synchronization Issues](#)

 **Note:** Run Viz Engine in Engine mode and not in Artist mode. The startup should be `viz.exe -n -w`. The Engine is correctly configured only if Viz starts with a full black window with `-w` parameter.

### 14.3.1 Performance Issues

Create a simple scene with a bar moving from left to right and back in an endless loop, and run this scene on the newly configured Video Wall to spot issues such as jittering, tearing effects, etc. When troubleshooting performance issues, always make sure to check the following before investigating further:

- Make sure that the system meets the [Minimum Hardware Configuration for Video Walls](#).
- Make sure that the [Pre-Requirements for all Setups](#) are met.
- Check that graphics and video devices are on the same CPU bus. The GPUs should always have priority.
- Make sure that the power connector to the graphics device is connected properly. The power connector must be 8-pin or use the 6-to-8-pin adapter included with the graphics device.
- Check that the [HP Z8 G4](#) or **BIOS Settings** are correctly configured.
- Check the [Viz Engine Video Wall Configuration Settings](#).
- [Configure the NVIDIA driver for Video Wall](#).

If performance problems persist, a possible solution may be to increase the **Reactivation Delay** value in Viz Configuration. Please refer to the setting [Video Input: Clip Input](#).

### 14.3.2 Steps to Recover from Severe NVIDIA Mosaic Driver Related Issues

1. Remove the NVIDIA drivers.
2. Shutdown the system.
3. Ensure that all monitor cables are connected properly to the graphics card.
4. Boot the system.
5. Reinstall the NVIDIA drivers.

### 14.3.3 Experiencing BSOD or System Freeze while Setting up Mosaic

While operating in Mosaic mode, any changes to the physical setup, such as adding or removing monitors, can cause a system crash resulting in a Blue Screen of Death or complete system freeze. There is a chance to run into follow-up issues (mentioned in this chapter) after the system has rebooted.

### 14.3.4 Only Some Displays of the Video Wall display an Image

There can be multiple reasons for this. Please ensure that:

- All monitors are connected properly to the graphics device and that they are active.
- Delete and re-create your Mosaic setup in the NVIDIA Control Panel.
- Please refer to section [Steps to recover from severe NVIDIA Mosaic driver related issues](#) in case the issue persists.

### 14.3.5 Missing NVIDIA Control Panel Settings

Please perform a re-installation of the NVIDIA driver as mentioned in section [Steps to recover from severe NVIDIA Mosaic driver related issues](#). A known cause for this behavior are physical changes to an existing video-wall setup, for instance adding or removing monitors, while operating in Mosaic mode.

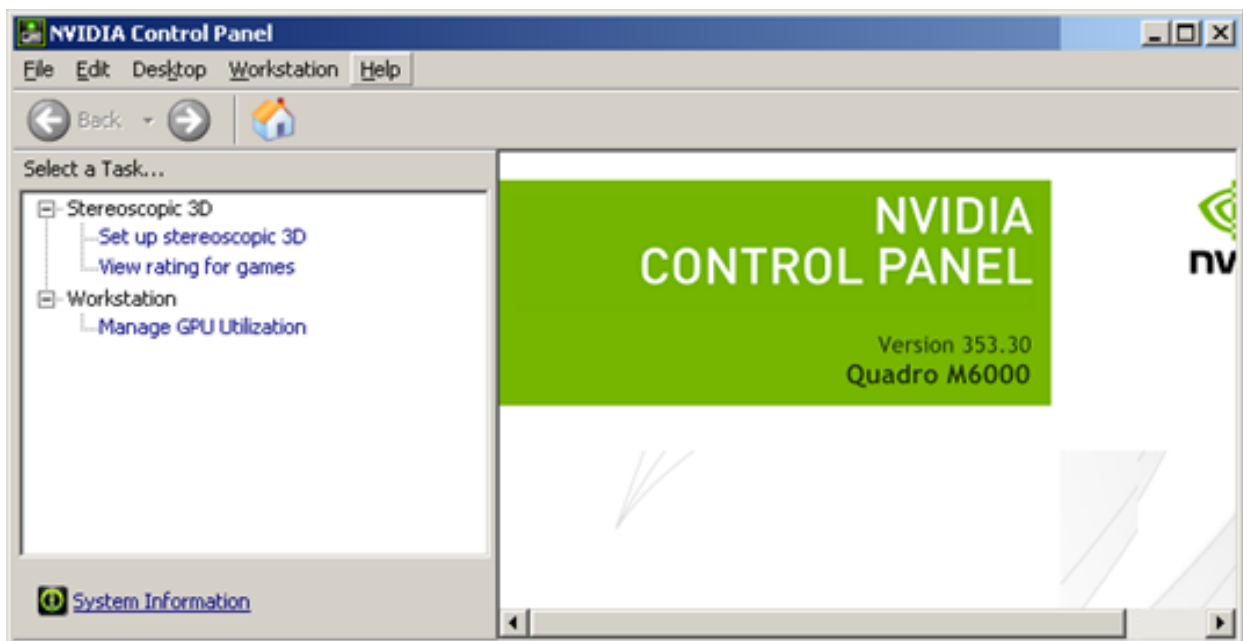

### 14.3.6 NVIDIA Control Panel Crashes

There is a possibility that the NVIDIA Control Panel crashes during Mosaic configuration, although this is not considered a reliable indicator on whether a driver re-installation is required or not. Sometimes the NVIDIA Control Panel can be restarted manually, and usually rebooting the machine should suffice.





Please refer to section [Steps to recover from severe NVIDIA Mosaic driver related issues](#) if the issue persists.

### 14.3.7 Mosaic Configuration Not Supported Error

If running with two or more cards, make sure the same outputs are used on each card. For example, if using two DisplayPort outputs and one DVI output on the first card, the same outputs must be used on the second card, etc. Failure to do so may result in Mosaic setup failure, with an error message stating that the configuration is not supported.

### 14.3.8 G-Sync Status LEDs or Topology Reports Indicate a Synchronization Issue

If the status LEDs on the NVIDIA G-Sync status LEDs indicate an issue, or the topology reports "The display is locked to the house sync signal" for all displays, the topology view may indicate that everything is fine at first sight. However, when taking a closer look at the topology, it reveals that all monitors seem to sync to the **house sync signal** instead of reporting that the display is locked to the **frame lock sync** pulse:

	 Samsung SMMD230 (1 of 4)		Mosaic Display (2 x 2 topology)
	Display state		Server
	Resolution, refresh rate , color depth		3840 × 2160 pixels, 49.998 Hz, 32 bpp
	Timing		The display is locked to the house sync signal

This indicates that there exists a synchronization issue which needs to be fixed. Solving this may require going through one or several of the following steps:

1. **Re-establish synchronization**
  - a. Disable display synchronization in section **Synchronize Displays**.
  - b. Re-establish synchronization.  
See the [NVIDIA Mosaic Configuration for 1080i50](#) or [NVIDIA Mosaic Configuration for 1080i60M](#) sections for more detailed instructions.
2. **Reconnect G-SYNC signal cables**
  - a. Physically disconnect the sync cable from the G-SYNC card.
  - b. Reconnect the sync cable.
  - c. Switch synchronization back on in the NVIDIA Control Panel. Go to **Synchronize Displays** and set the radio button to **An external house sync signal**. See the [NVIDIA Mosaic Configuration for 1080i50](#) or [NVIDIA Mosaic Configuration for 1080i60M](#) sections for more detailed instructions.
  - d. Verify the LEDs on the [NVIDIA Quadro Sync](#), or in the Topology Inspector of the NVIDIA Control Panel.
  - e. If this does not help, try to reboot the machine.

In case this does not fix the issue:

1. Disable display synchronization in section Synchronize Displays.
2. Shutdown the machine.
3. Check cabling and signal sources.
4. Reboot the machine.
5. Re-establish synchronization as mentioned in section Synchronize Displays.

### 14.3.9 Poor Performance when Using GFX Channels as DVE

On high resolution Video Walls in particular, poor performance may be experienced when using GFX channels as DVEs. This is caused by anti-aliased "blitting". To disable anti-aliasing on GFX channels, open the Viz configuration file, locate the `gfx_channels_antialiased` string, and set the value to `0`. The default value is `1`.

 **Example:** `gfx_channels_antialiased = 1`

### 14.3.10 Jittering on HP Z840

Jittering on the HP Z840 is most commonly caused by a missing swapgroup. Make sure to run the `RENDERER_JOIN_SWAPGROUP 1` command to the Engine.

### 14.3.11 Other Synchronization Issues

When attaching the connector cables between the graphics card and the G-SYNC card, make sure that the red line on all of the connector cables are facing the card's mounting bracket, towards the back of the case. Failure to do so can result in synchronization issues. In rare cases, syncing with only the NVIDIA G-SYNC can result in more stable synchronization. If all else fails, try disconnecting the reference signal from the Matrox board.

---

## 14.4 HDR Window Configuration

### 14.4.1 Introduction

Viz Engine can be configured to create window contexts with enabled HDR compatibility. The content color space must be sRGB, which is then displayed using an adjustable brightness level in scRGB using a 16-bit float per channel framebuffer.

**Warning:** Rendering to HDR-enabled windows only works in combination with Viz Engine Render Pipeline scenes and does not work with the Classic Render Pipeline.

### 14.4.2 Prerequisites

- Microsoft Windows 10, version 1709 or later.
- An HDR compatible monitor with HDR enabled via Microsoft Windows Display Settings.

**Information:** It is recommended that all monitors used are capable of running HDR, because if Microsoft Windows decides to create a window on a non-HDR monitor, HDR cannot be enabled at all.

### 14.4.3 Configuration

#### Viz Engine

Open Viz Engine Configuration file (for example, *C:\ProgramData\vizrt\VizEngine\VizEngine-0.cfg*) and set the flag `hdr_preview_mode` to `1`. All Viz Engine Renderer window contexts are then created with HDR compatibility enabled.

For each of them, the console shows on which display it was created, the current HDR enablement state and the maximum `WhiteLevel`. If those lines are not printed, HDR window rendering is not available at all.

#### Example

```
Display Info:
o Name: \\.\DISPLAY2
o HDR: Enabled
o WhiteLevel: 264
```

## Windows Display Settings

To adjust the brightness of the SDR content, Viz Engine reads the display setting called **HDR/SDR brightness balance**. The slider can be found under **Display Settings > Windows HD Color settings** for any HDR enabled display. The rendering output reflects any change to the slider value immediately.

### 14.4.4 References

- <https://learn.microsoft.com/en-us/windows/win32/direct3darticles/high-dynamic-range>
- <https://en.wikipedia.org/wiki/ScRGB>

---

## 14.5 Video Wall Setup Instructions

This section has information on the following topics:

- [Pre-Requirements for All Setups](#)
- [Configure the NVIDIA Driver for Video Wall](#)
- [Order of Steps to Set Up NVIDIA Mosaic](#)
- [NVIDIA Quadro Sync](#)
  - [To Check the Status LEDs of the G-Sync Device](#)

Additional information:

- [Multiplay Troubleshooting Guide](#)
- [www.datapath.co.uk](http://www.datapath.co.uk) for Datapath Devices.

It is recommended to use only one GPU. Using more than one GPU results in a performance drop. If you are required to use more than one GPU, make sure that the monitor cables are the same for all cards. For example, a video wall configuration with six monitors on two cards, should use three outputs on each card with the same connectors on each card. If required, adapters can be used to connect the displays to the machine.

- Make sure that both GPU and Matrox boards are bound to the same CPU per PCI slot. The CPU assignment is usually listed in the cover or documentation of your machine. If possible, also bind a M264 board to this CPU.
- Make sure the NVIDIA G-SYNC card receives the same reference signal as the video board:

 **Info:** A G-sync board is always required, no matter how many GPUs are installed.

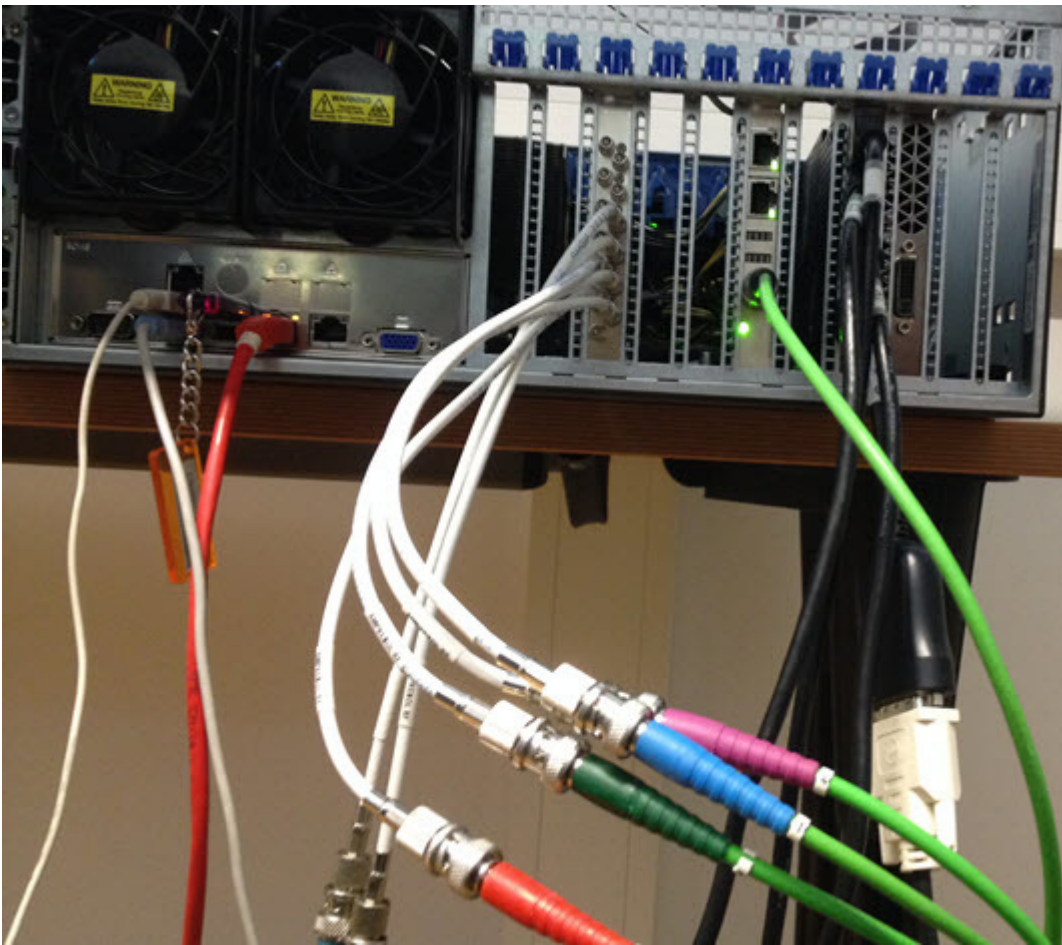

### 14.5.1 Pre-Requirements for All Setups

1. Shut down the machine.
2. Install the graphics device, NVIDIA G-Sync board and Matrox X.mio board. Please refer to the related documentation included with the hardware. For multiple CPU setups with two graphics devices, make sure that both devices are on the same CPU.

**✘ IMPORTANT!** NVIDIA GPUs must be installed using the 8-pin power adapter which is included with the card. Installing the card using a 6-pin power connector has a negative impact on performance and can lead to unexpected system behavior with reports of a PCI error.

3. Connect the NVIDIA G-Sync and Matrox X.mio to the Genlock source. When attaching the connector cables between the graphics card and the G-SYNC card, make sure that the red line on all of the connector cables are facing the card's mounting bracket, towards the back of the case. Failure to do so can result in synchronization issues.
4. Connect the Matrox X.mio video input and output jacks.
5. Connect one monitor only to the graphics card, for the initial setup.
6. Boot the machine.
7. Install NVIDIA drivers and Matrox DSX.TopologyUtils. Reboot the machine as required.
8. Shut down the computer and connect all remaining video wall displays to the graphics card. For configurations with more than one graphics card, make sure to use the same outputs on all cards.



9. Boot the machine and proceed with the [Order of Steps to Set Up NVIDIA Mosaic](#).

## 14.5.2 Configure the NVIDIA Driver for Video Wall

1. Using the standard NVIDIA settings for Viz Engine, change the following parameter: **Vertical Sync:** On .
2. Set the power management to **Prefer maximum power**.
3. Apply the changes, then select **3D App - Video Editing** from the profile drop-down menu, and apply changes again:

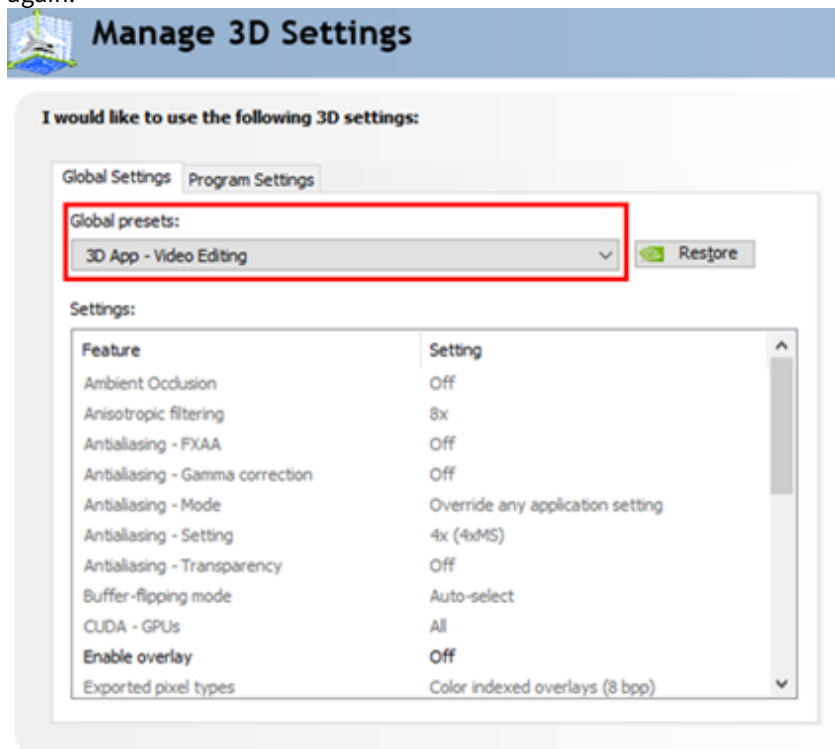

## 14.5.3 Order of Steps to Set Up NVIDIA Mosaic

Please take a look at the [Troubleshooting](#) section prior to setting up NVIDIA Mosaic for the first time, as it provides solutions for common issues that may arise during Mosaic setup.

**✘ IMPORTANT!** For 50 Hz setups, make sure that there is no **EDID-file** loaded. Then start the Mosaic configuration, there is no need to perform more steps. For 59.94 Hz, load the EDID-file and make sure it is applied properly by verifying every single monitor in the **View System Topology** panel.

If running with two or more cards, make sure the same outputs are used on each card. For example, if using two DisplayPort outputs and one DVI output on the first card, the same outputs must be used on the second card, etc. Failure to do so may result in Mosaic setup failure, with an error message stating that the configuration is not supported.

1. Enter Mosaic configuration in the NVIDIA control panel and setup Mosaic for the required refresh rate:
  - [NVIDIA Mosaic Configuration for 1080i50](#)
  - [NVIDIA Mosaic Configuration for 1080i60M](#)

2. Synchronize the GPU to the internal house-sync, by configuring the NVIDIA G-Sync device in the **Synchronize displays** panel of the NVIDIA Control Panel:
  - [Video Wall Setup Instructions](#). Proceed with adjusting the [Viz Engine Video Wall Configuration Settings](#) to finalize the video wall configuration.

#### 14.5.4 NVIDIA Quadro Sync

The NVIDIA Quadro sync card is used to synchronize the graphics cards with the house clock, and is required for video wall configurations.

V-sync must still be set in the NVIDIA driver to ensure that the OpenGL SwapBuffer operation takes place at the vertical retrace, to avoid tearing between two frames. The Quadro Sync board synchronizes the vertical retrace of all the displays, it does not lock the OpenGL SwapBuffer operation to the vertical retrace.

To Check the Status LEDs of the G-Sync Device

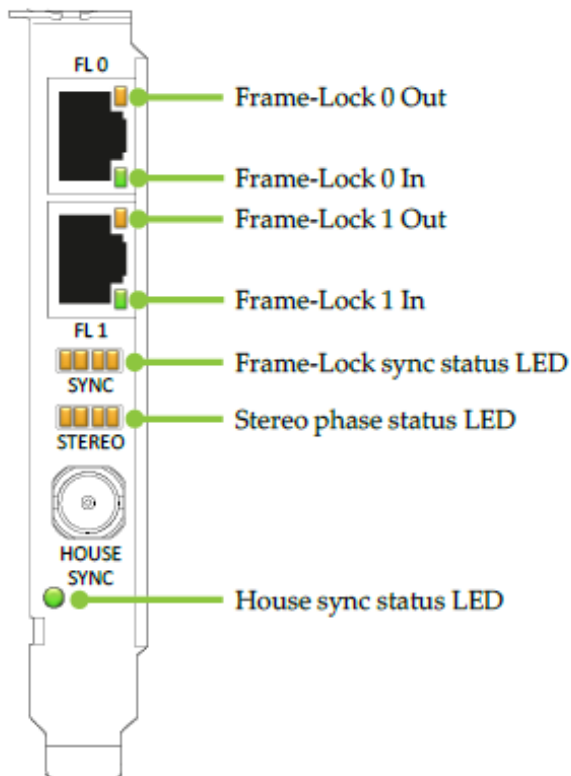

1. Ensure the House sync status LED indicates that a proper sync signal is connected.
2. Ensure that the Frame-Lock sync status LED is shining green. It must not blink or shine orange. When sync is stable, the Stereo phase status LED should also be lit green.

## 14.5.5 Configuration Using Datapath Devices

This section has some basic information on how to configure a videowall using [Datapath devices](#):

- [Prepare the Layout](#)
- [Prepare the Input](#)
- [Attach the Device\(s\)](#)
- [Troubleshooting](#)

For detailed instructions on how to use these devices, please refer to <https://www.datapathdocuments.co.uk/downloads/>.

A Maxwell or Pascal GPU supports up to 4K (5K Pascal) resolution per head. This allows for a maximum resolution of 16Kx16K on one GPU. As single GPU installations are preferred for performance issues one can utilize a multi display distributor from Datapath to grab the incoming signal and split it up into four individual HD signals. A single head drives four HD outputs, four heads can drive up to 16 HD outputs. The Datapath devices are recognized by the NVIDIA driver as one single monitor with its full resolution. Additionally, each Datapath device can be synced on a house signal, usually the same sync used for synchronizing the GSync board and the Matrox devices.

Please follow these steps to setup a videowall based on Datapath devices. It is recommended to perform each of the following steps one after the other:

- Prepare the Datapath environment.
- Setup NVIDIA Mosaic.
- Synchronize your Mosaic.



**Bezel correction:** A bezel correction needs to be done on Datapath side, as the NVIDIA driver only sees one big display and is not aware of any bezel information.

### Prepare the Layout

Choose your monitor vendor and add the number of screens you want to utilize.

Please make sure the resolution is the correct native resolution of your monitors and the refresh rate matches your final refresh rate (50Hz or 59.94Hz). After that, press **Add Monitors to Wall** button. This represents the physical alignment of your monitors. Perform any modification of your alignment in this screen.



**Note:** You can also rotate and flip monitors within this view.

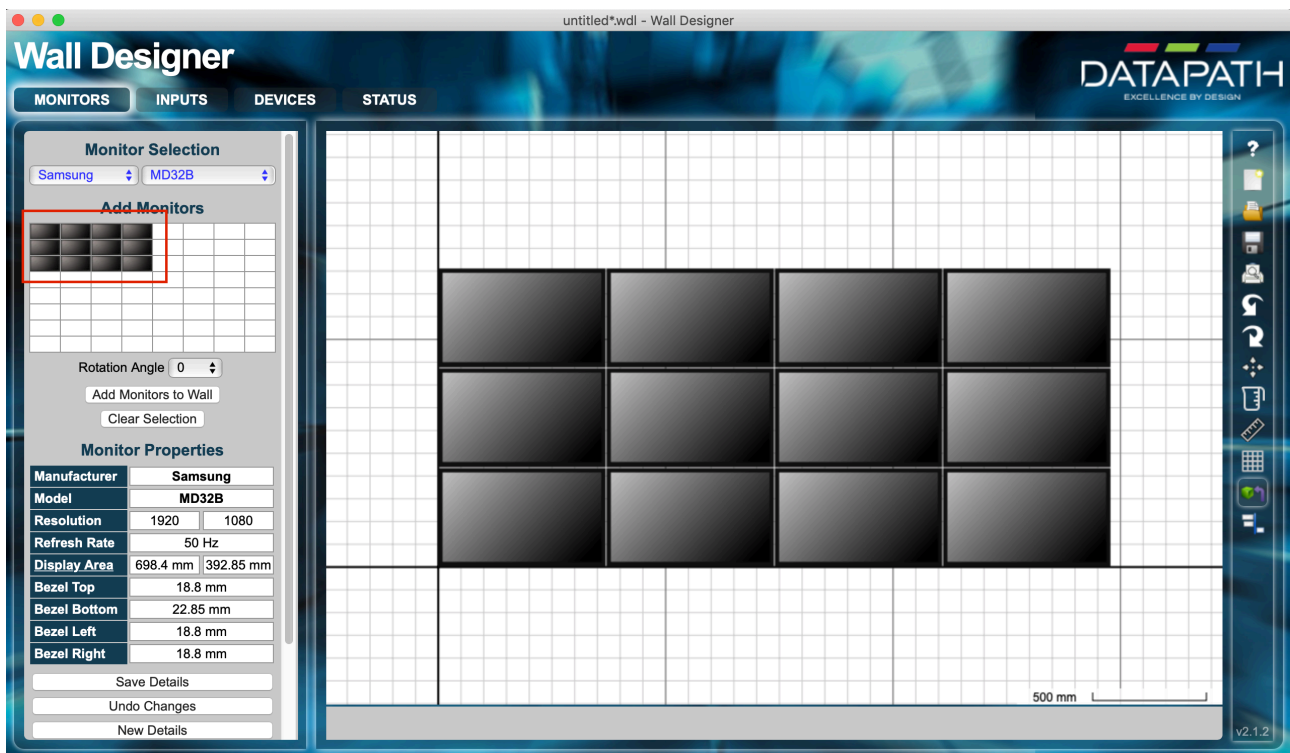

## Prepare the Input

In this step, we create a virtual device recognized by the NVIDIA GPU as monitor(s). Create as many inputs as heads (=Datapath devices) physically connected to your NVIDIA GPU. In our example, we use three devices, each one of them is driving one row. One input is 4x1920px and 1080 pixels height. The input needs to be configured to be 7680px \* 1080px. This is the same resolution as NVIDIA needs to recognize them.

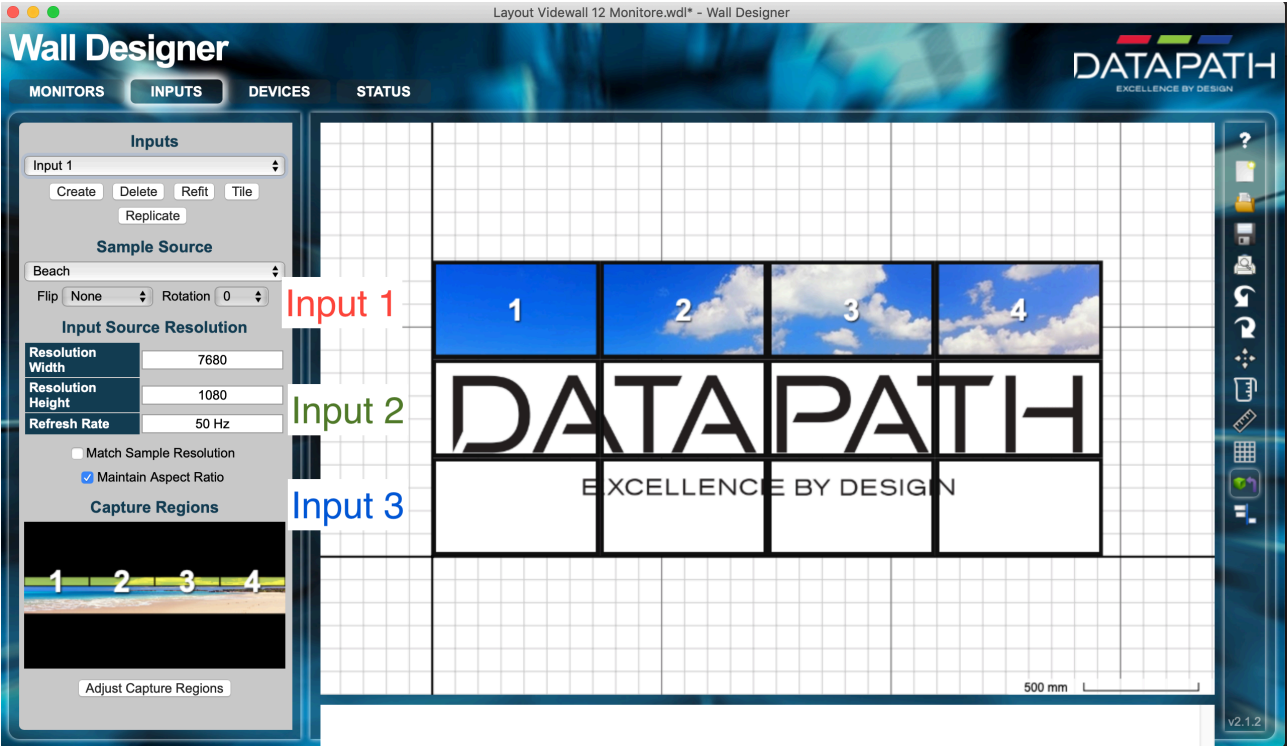

Press **Adjust Capture Regions** if you need to adjust the area the input captured by the various monitors. The alignment of monitors can be fine tuned pixel accurate. Any bezel correction needs also be done here. Make sure the displays align correctly to the configured input.

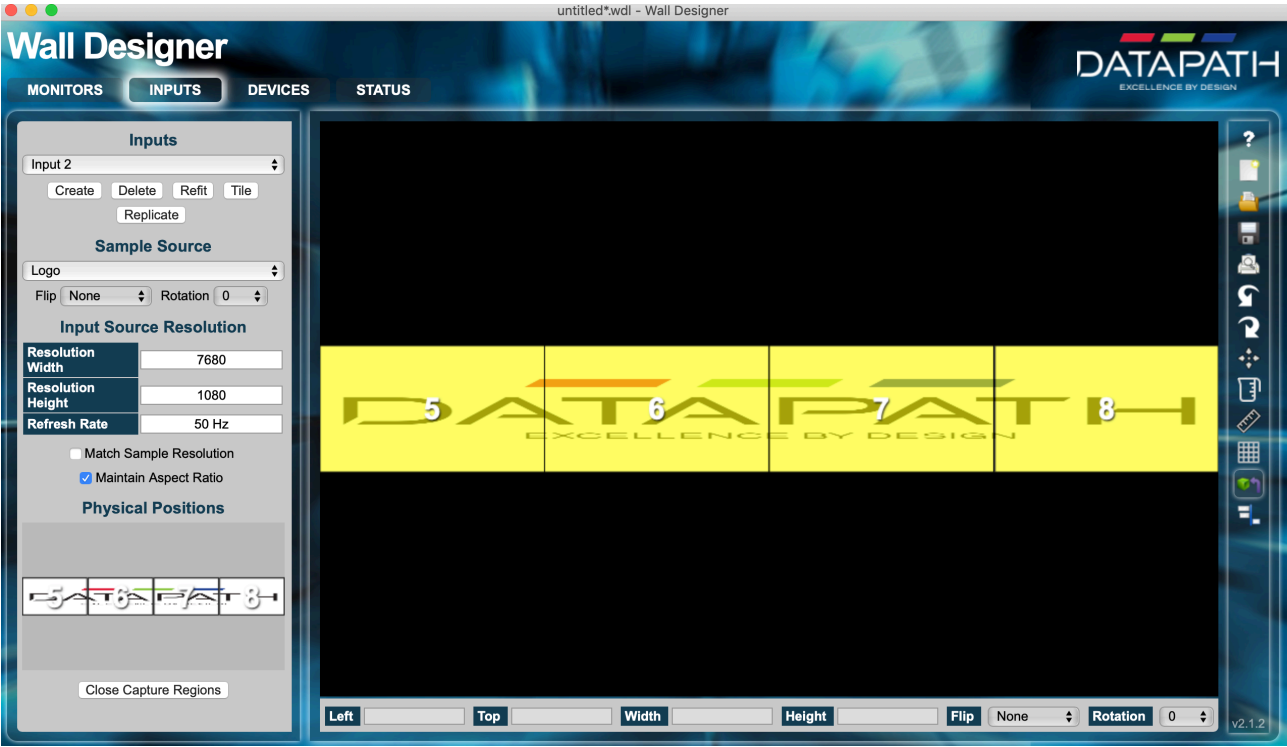

## Attach the Device(s)

We need to connect the input to our physical Datapath devices. This is done in the devices section of Wall Designer. If you hit the **Auto Configure Device** on your current device, it generates an input, a Datapath device and the number of monitors. Now, we need to assign the Datapath devices to the one available. Make sure your environment discovered all your Datapath devices either on the network or connected via USB. This can be done in the status page. If no devices are present, they must be added manually.

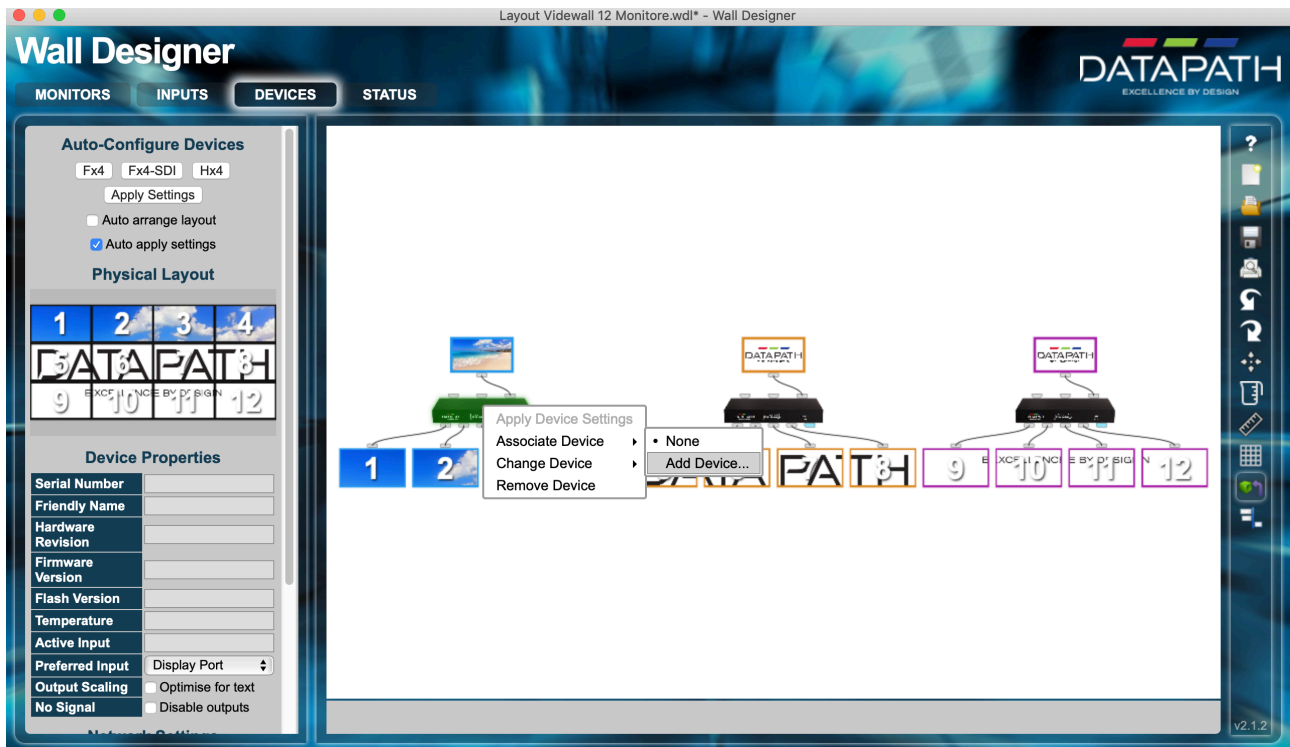

Right click on the **Datapath** and assign the correct one. If it is missing from the list, please manually add the IP number of your device. (This can be obtained by connecting it via USB). Once you click on the **Apply Settings** button, the configuration activates and the NVIDIA should recognize three virtual monitors with a resolution of 7680x1080 each. Verify the input by clicking on the input image(s). Once this step has been completed, you can continue by creating your NVIDIA mosaic:

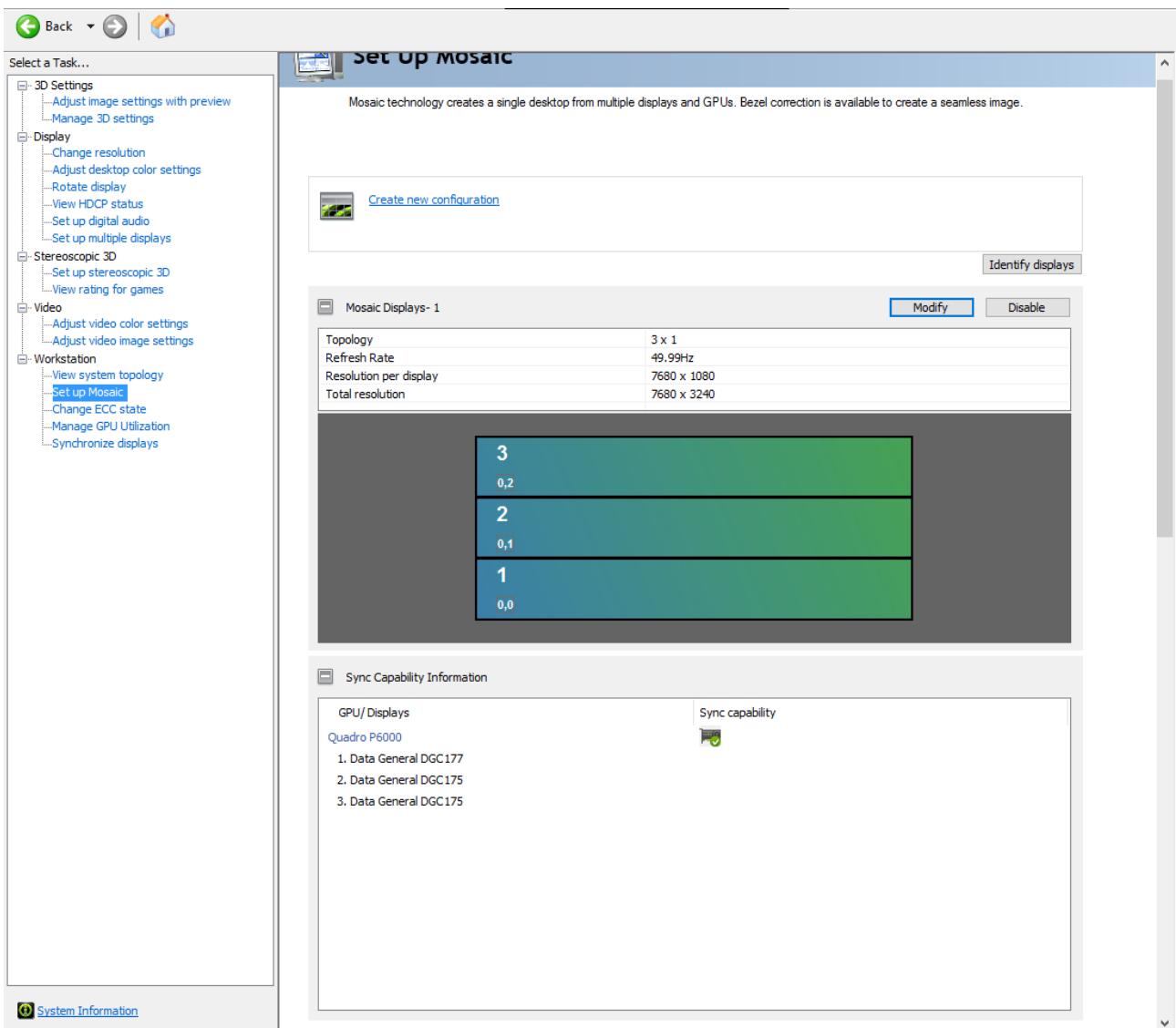

## Troubleshooting

Detailed setting of each Datapath device is available by opening its built-in webpage. It allows setting proper name, network settings, correct timing and most important correct sync settings. Open the webpage and verify the correct timing for the sync and the refresh rate for each monitor. It can also display a test pattern instead of the NVIDIA output, which makes troubleshooting much more easier. If monitors remain black, but give a proper image when using a test pattern, verify in the NVIDIA control panel by checking the color depth per display. It must be set to eight bits/pixel, not six bits/pixel.

## 14.5.6 NVIDIA Mosaic Configuration for 1080i50

The procedure described below assumes that the [NVIDIA Driver Configuration](#) has been completed during initial setup of the computer running Viz Engine. If not, refer to the [Graphics Boards](#) chapter for details on setting up the NVIDIA hardware correctly for use with Viz Engine.

1. Enter NVIDIA Control Panel.
2. Disable synchronization of displays, by selecting **On another system**.

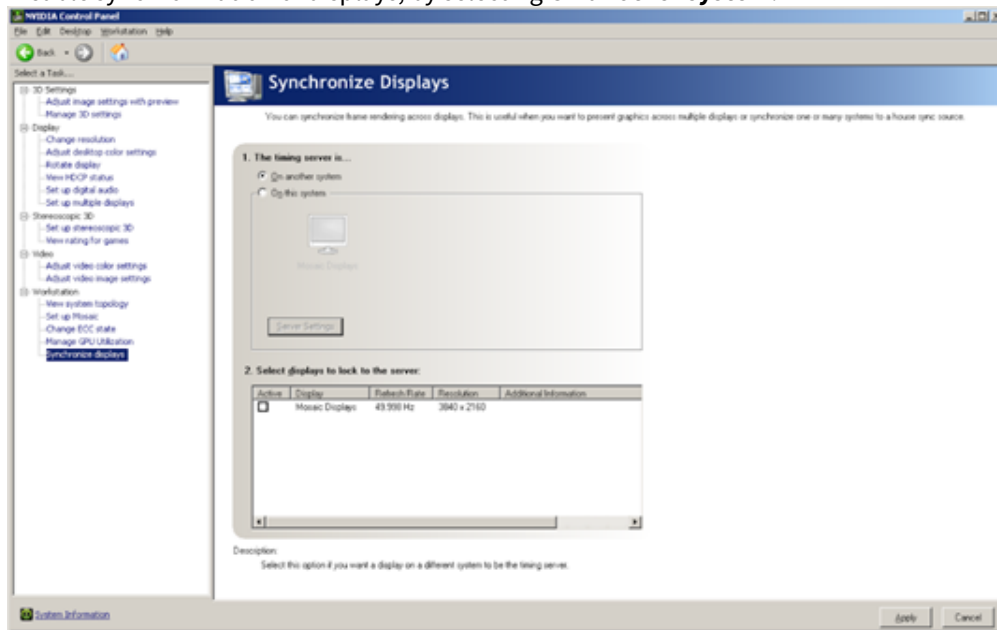

3. Establish a 50Hz Mosaic setup by selecting **Set up Mosaic** from the **Workstation** panel:
  - In step **1. Select topology**, make sure to leave the **I am using recommended connections for the selected topology** check box unchecked.
  - In step **2. Select displays**, select all displays that are to be used for the video wall, for example 1, 2, 3 and 4, and select **50 Hz** as frequency rate.
  - In step **3. Arrange displays**, drag and drop the displays according to the physical arrangement, not by the **On Screen Display** numbering. This can result in the monitors being arranged as 1, 4, 3, and 2, ensuring proper layout.



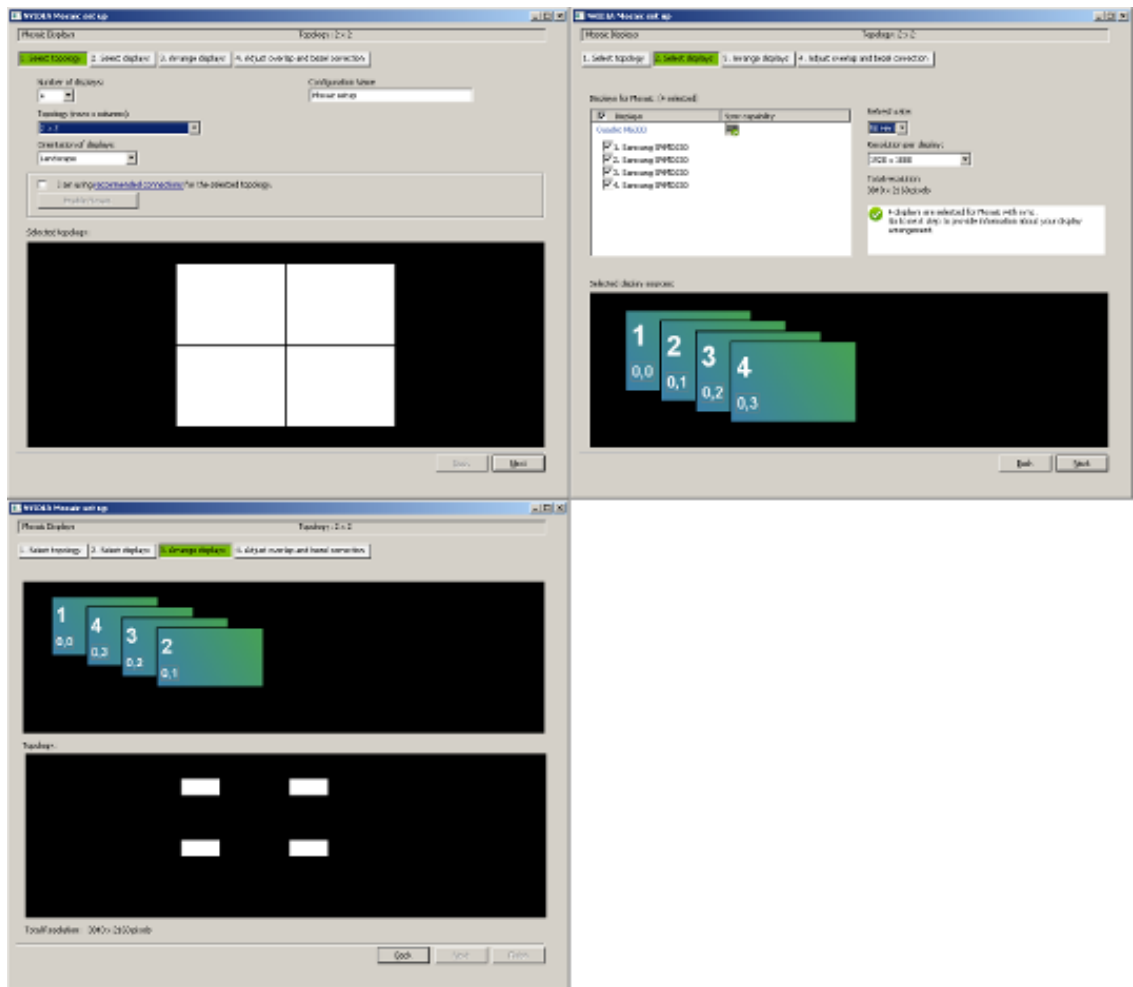

4. Enter section **Synchronize Displays** in the NVIDIA Control Panel and choose **On this system** for the question regarding the timing server, then click the **Server Settings** button.

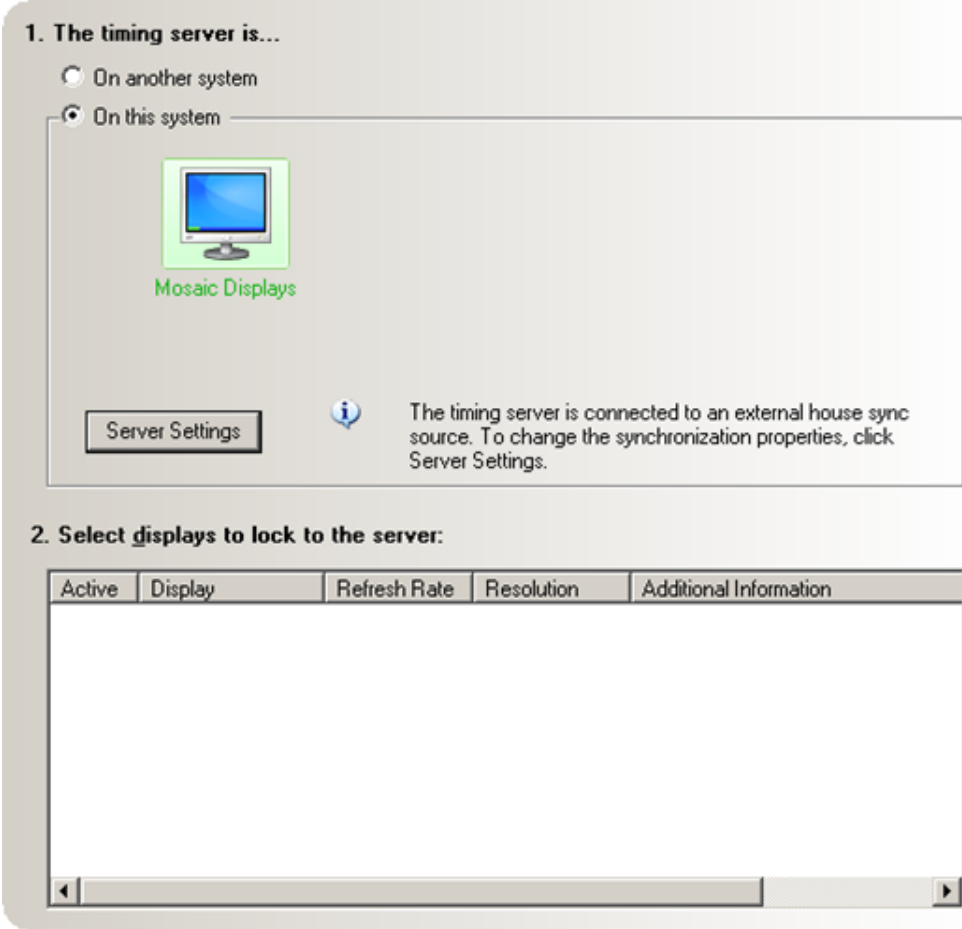

Make sure the presented server refresh rate matches the one of the incoming Genlock signal. Choose **An external house sync signal**. Leave all other settings as they are, and apply the changes.

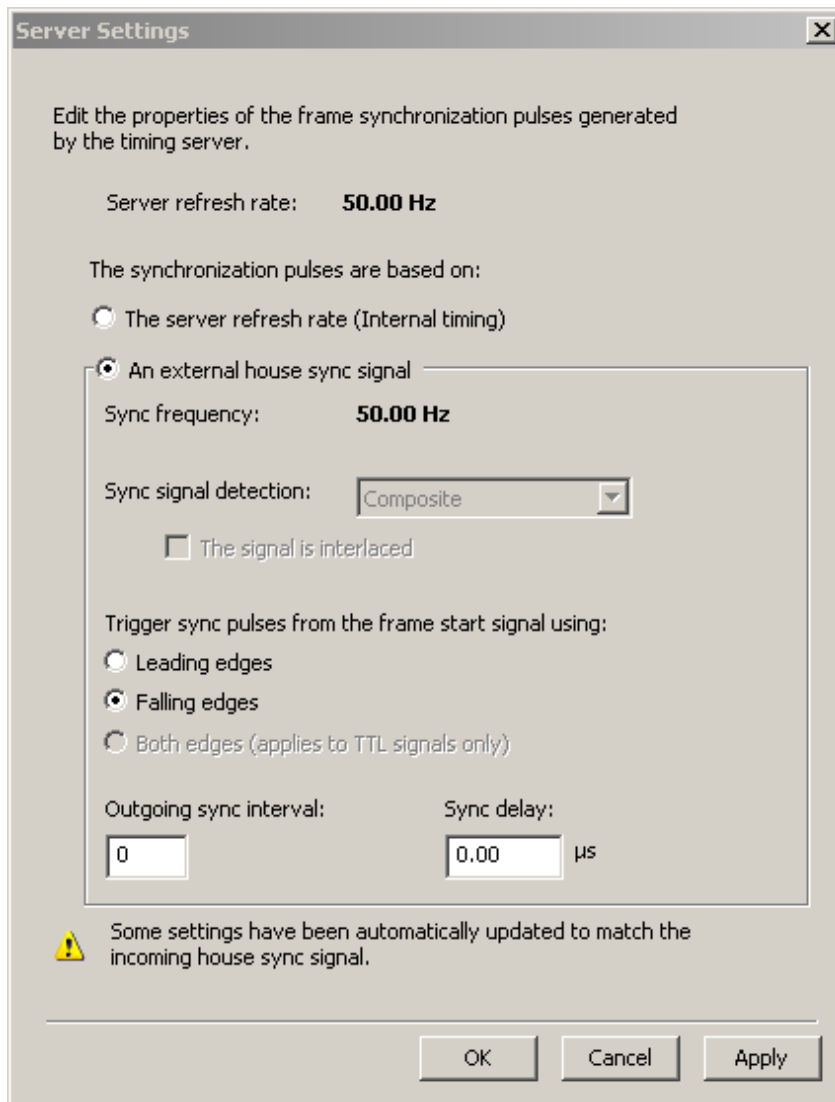

5. Check the **Topology** in the NVIDIA Control Panel:

**Mosaic Displays**

System topology	Status	Settings
<b>Mosaic Displays</b>		
Configuration		<a href="#">2 x 2 Topology</a>
Resolution, refresh rate		3840 × 2160 pixels, 50.00 Hz
Display Sync State		Quadro Sync Server
Timing		The display is locked to the house sync signal
OS Screen Identifier		2

The **View System Topology** panel reports that **The display is locked to the house sync signal** for one of the connected displays. For the other connected displays, the report states that **The display is locked to the frame lock sync pulse**.

**Displays and Graphics Cards**

System topology	Status	Settings
<input type="checkbox"/> <b>System</b>		
Driver version		353.30
Vertical sync		<a href="#">3D Application controlled</a>
3D Stereo		<a href="#">Disabled</a>
<input type="checkbox"/> <b>Quadro Sync (server)</b>		
FrameLock 0		Out
FrameLock 1		Out
External sync signal		Present (In use)
FrameLock sync pulse		Present
Sync settings		<a href="#">Synchronize Displays</a>
<input type="checkbox"/> Samsung SMMD230 (1 of 4)		Mosaic Display (2 x 2 topology)
Display state		Server
<input type="checkbox"/> Resolution, refresh rate , color depth		3840 x 2160 pixels, 49.998 Hz, 32 bpp
Timing		The display is locked to the house sync signal
<input type="checkbox"/> Samsung SMMD230 (2 of 4)		Mosaic Display (2 x 2 topology)
Display state		Client
<input type="checkbox"/> Resolution, refresh rate , color depth		3840 x 2160 pixels, 49.998 Hz, 32 bpp
Timing		The display is locked to the frame lock sync pulse

6. Check the LEDs on the [NVIDIA Quadro Sync](#).
7. Configure Bezel/Overlap for Mosaic in the NVIDIA Control Panel:

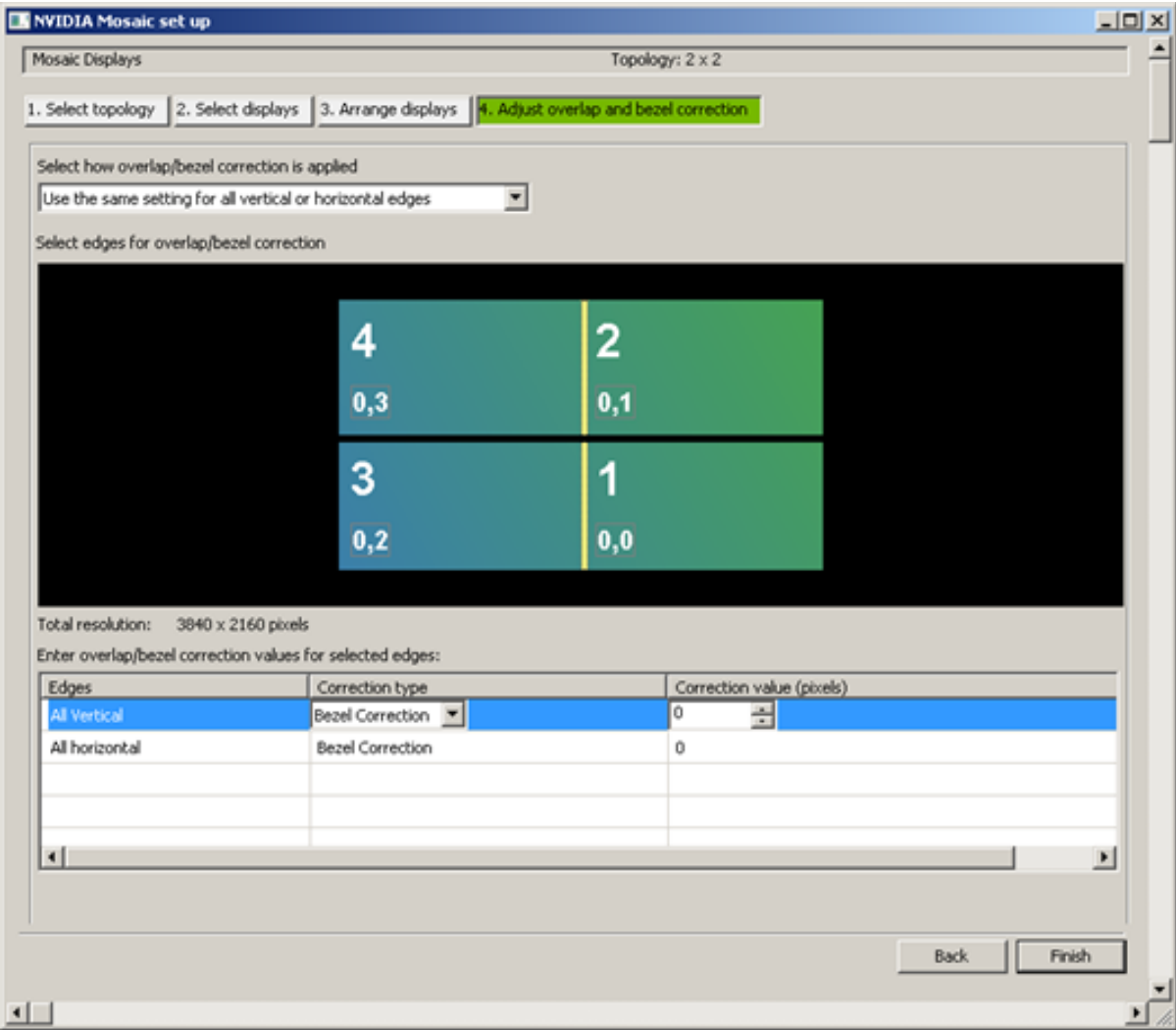

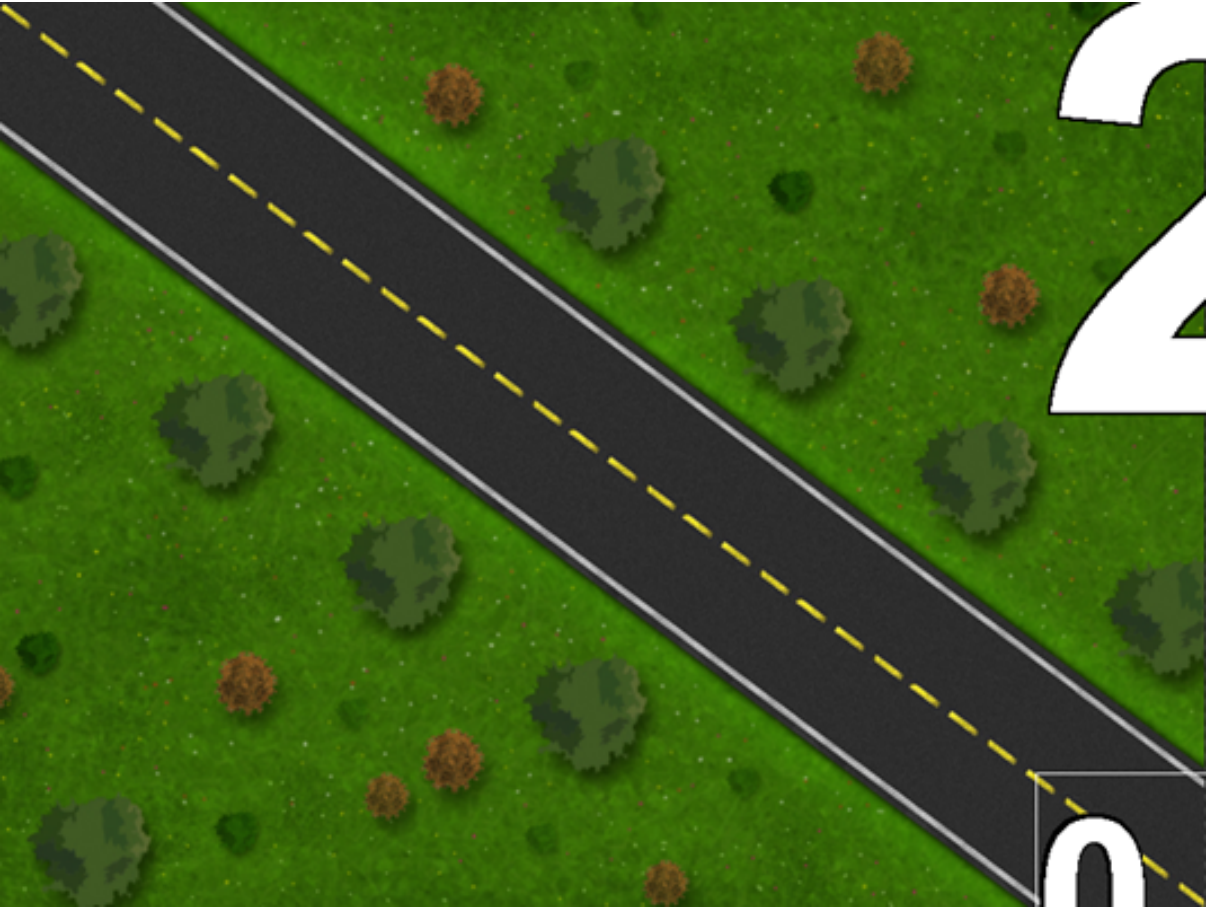

### 14.5.7 NVIDIA Mosaic Configuration for 1080i60M

In case the video-wall displays in use natively supports a refresh rate of 59.94 Hz, the setup procedure described in [NVIDIA Mosaic Configuration for 1080i50](#) can be followed, only selecting a refresh-rate of 59.94 Hz while creating the Mosaic:

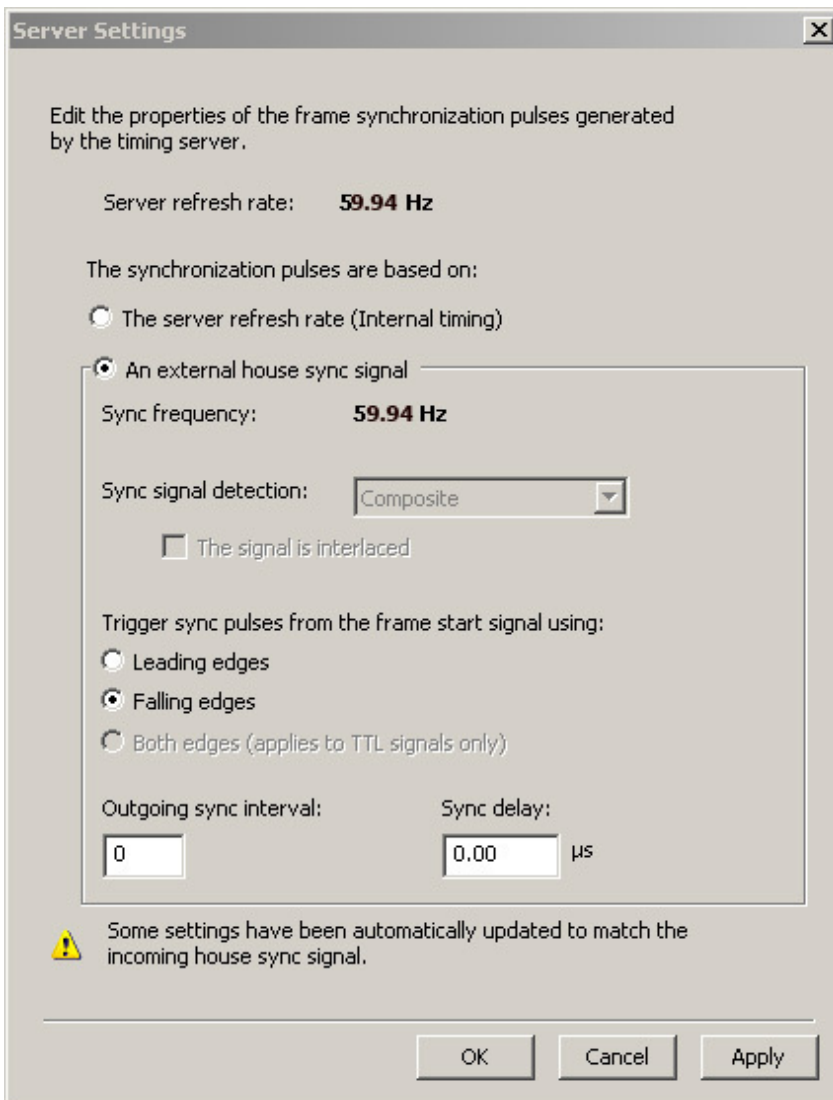

If this is not the case, a number of steps need to be performed in advance, as described in the section [To Create a Custom 59.94 Hz Resolution](#). An **EDID-file** is *always* required to run monitors that do not natively support 59.94 Hz frequency at that frequency. Contact the display hardware vendor to obtain the correct EDID file for the monitors in use.

1. To configure Mosaic for 1080i60M, follow the steps described in the [NVIDIA Mosaic Configuration for 1080i50](#) section. Make sure to select a refresh-rate of 59.94 Hz during step 2 of the Mosaic creation process. Depending on the NVIDIA driver installer, sometimes 59.94 Hz is not available from the **Refresh rate** drop-down list, even if the loaded EDID-file enables this frequency rate. If this is the case, select 60 Hz:

Refresh rate:



Resolution per display:

Total resolution:  
 3840 x 2160 pixels







 4 displays are selected for Mosaic with sync.  
 Go to next step to provide information about your display arrangement.

- Once Mosaic is configured and the G-Sync device has been locked to the house-sync, the topology in the NVIDIA control panel should look as follows, with the report for one of the connected displays stating **The display is locked to the house sync signal**.

**Mosaic Displays**

System topology	Status	Settings
 <b>Mosaic Displays</b>		
Configuration		<a href="#">2 x 2 Topology</a>
Resolution, refresh rate		3840 x 2160 pixels, 59.94 Hz
Display Sync State		Quadro Sync Server
Timing		The display is locked to the house sync signal
OS Screen Identifier		2

**Displays and Graphics Cards**

System topology	Status	Settings
 <b>System</b>		
Driver version		353.30
Vertical sync		<a href="#">3D Application controlled</a>
3D Stereo		<a href="#">Disabled</a>
 <b>Quadro Sync (server)</b>		
Framelock 0		Out
Framelock 1		Out
External sync signal		Present (In use)
Framelock sync pulse		Present
Sync settings		<a href="#">Synchronize Displays</a>



[-]  Samsung SMMD230 (2 of 4)		Mosaic Display (2 x 2 topology)
Display state		Server
[+] Resolution, refresh rate , color depth		3840 x 2160 pixels, 59.939 Hz, 32 bpp
Timing		The display is locked to the house sync signal

The report for all other displays should be that **The display is locked to the frame lock sync pulse.**

[-]  Samsung SMMD230 (3 of 4)		Mosaic Display (2 x 2 topology)
Display state		Client
[+] Resolution, refresh rate , color depth		3840 x 2160 pixels, 59.939 Hz, 32 bpp
Timing		The display is locked to the frame lock sync pulse

3. Check the LEDs on the [NVIDIA Quadro Sync](#).
4. Configure Bezel/Overlap for Mosaic in NVIDIA control panel:

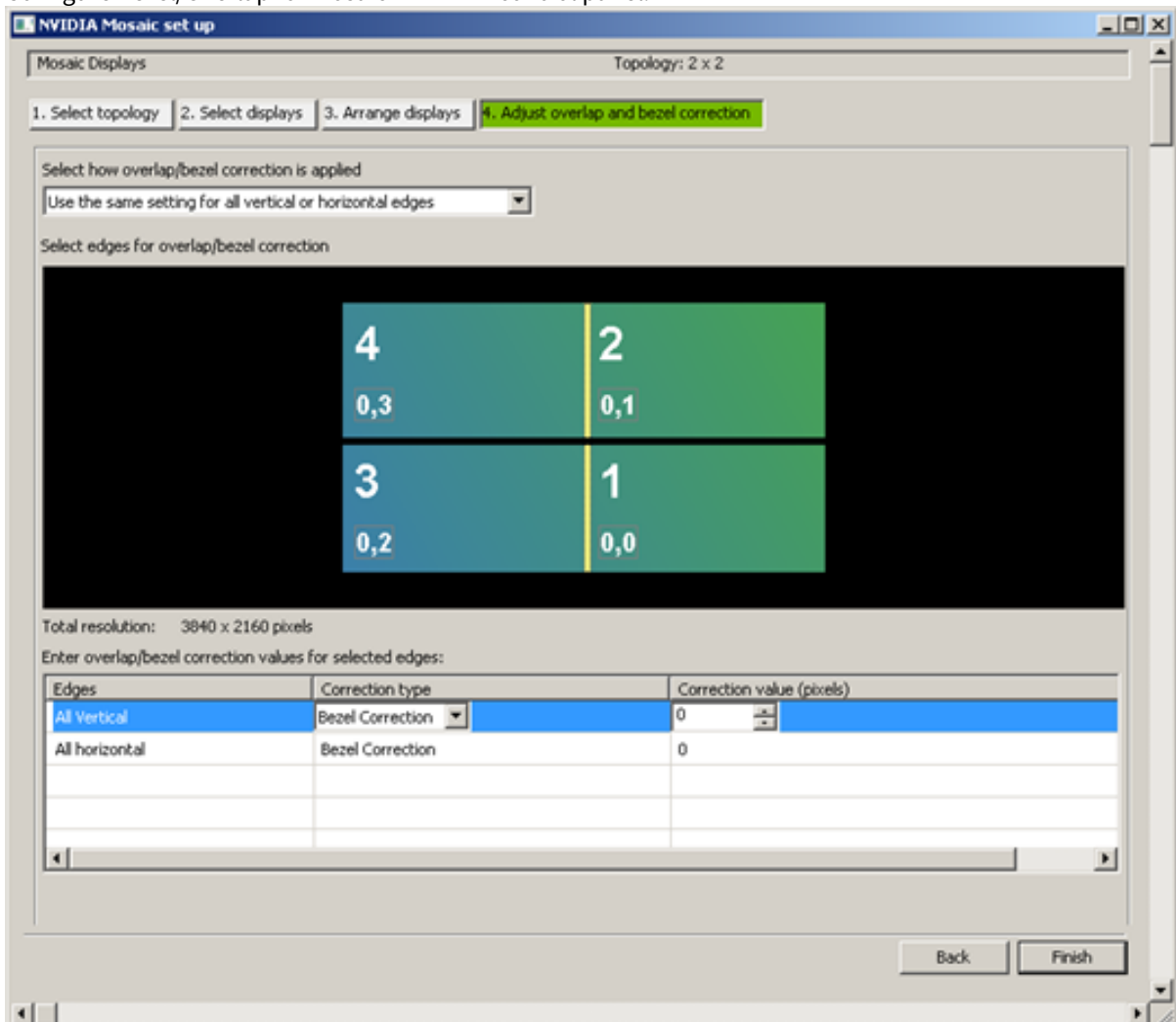

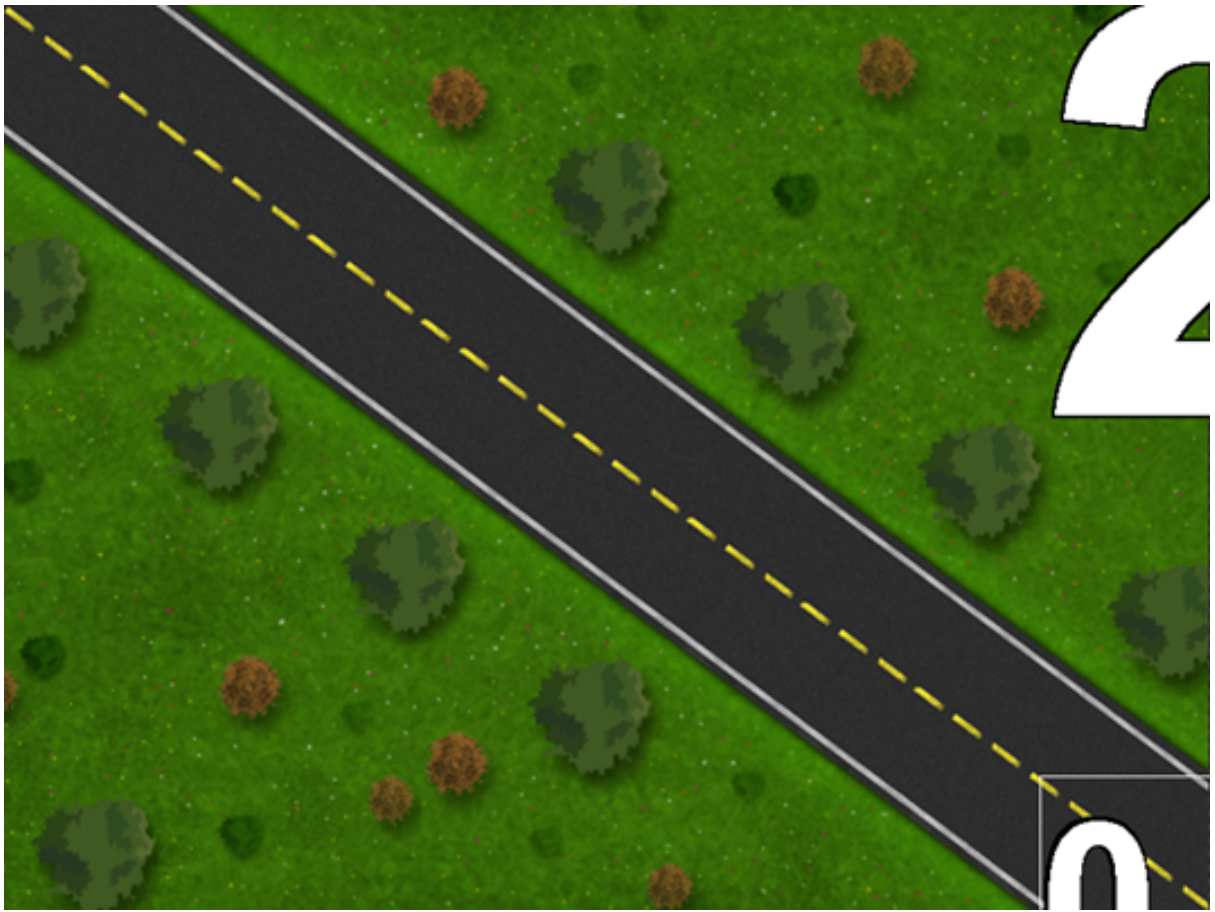

5. Proceed with configuring the required [Viz Engine Video Wall Configuration Settings](#).

### 14.5.8 Custom Resolution for 59.94 Hz Refresh Rate

Video-wall displays may not natively support a refresh rate of 59.94 Hz. Such displays *always* require an **EDID-file** to be able to run at that frequency. Contact the display hardware vendor to obtain the correct EDID file for the monitors in use. Furthermore, a number of steps must be carried out before initiating the [NVIDIA Mosaic Configuration for 1080i60M](#).

This section contains information on the following topics:

- [To Load an EDID File](#)
- [To Create a Custom 59.94 Hz Resolution](#)
- [To Change from 59.94 Hz to 50 Hz Refresh Rate](#)

**⊗ Caution:** Loading unsupported or corrupted EDID settings for a display may render the source device unable to output any video signal to the display. Please refer to the information supplied by the display hardware vendor for information on the displays capabilities or limitations.

#### To Load an EDID File

1. In the **NVIDIA Control Panel**, expand the **Workstation** section of the **Select a Task...** menu and click **View system topology**:

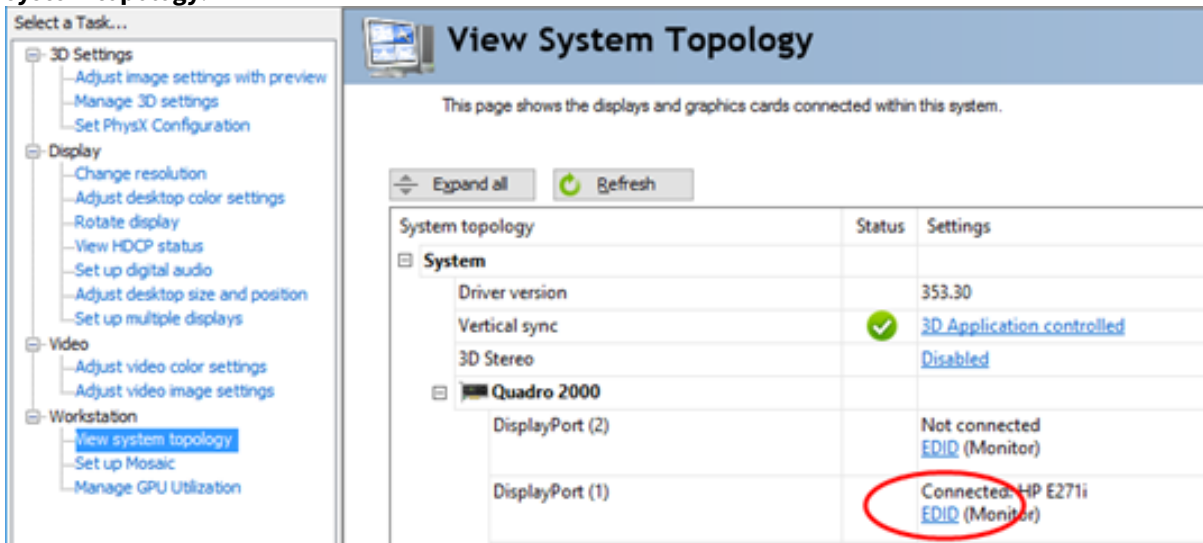

2. Click the **EDID** link on one monitor, and select the **Load** tab.
3. Click the Browse button and select the EDID file to be loaded. This file is usually included on the CD or DVD containing drivers, utilities and documentation for the display. If not, please contact the display manufacturer to obtain the required file.

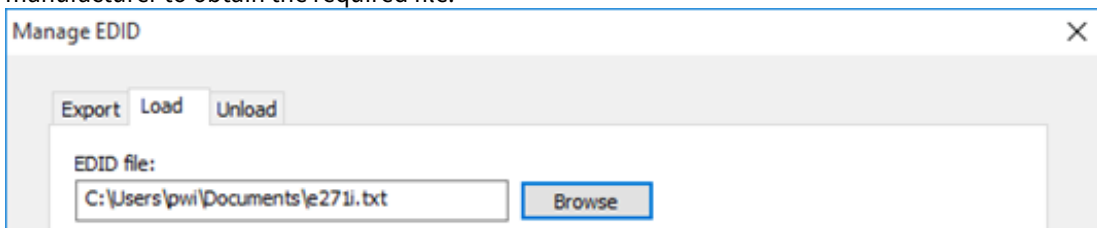

4. In the **Select Connector to force EDID** panel, check all connected displays, then click **Load EDID**.
5. When the EDID file has been applied to all displays, check the properties of every display in the **View System Topology** section. They must all run on 59.94 Hz.
6. Proceed [To Create a Custom 59.94 Hz Resolution](#).

### To Create a Custom 59.94 Hz Resolution

1. Enter the **Change resolution** section of the NVIDIA control panel.
2. In the first section, **Select the display you would like to change**, select display number 1 and click the **Customize...** button:

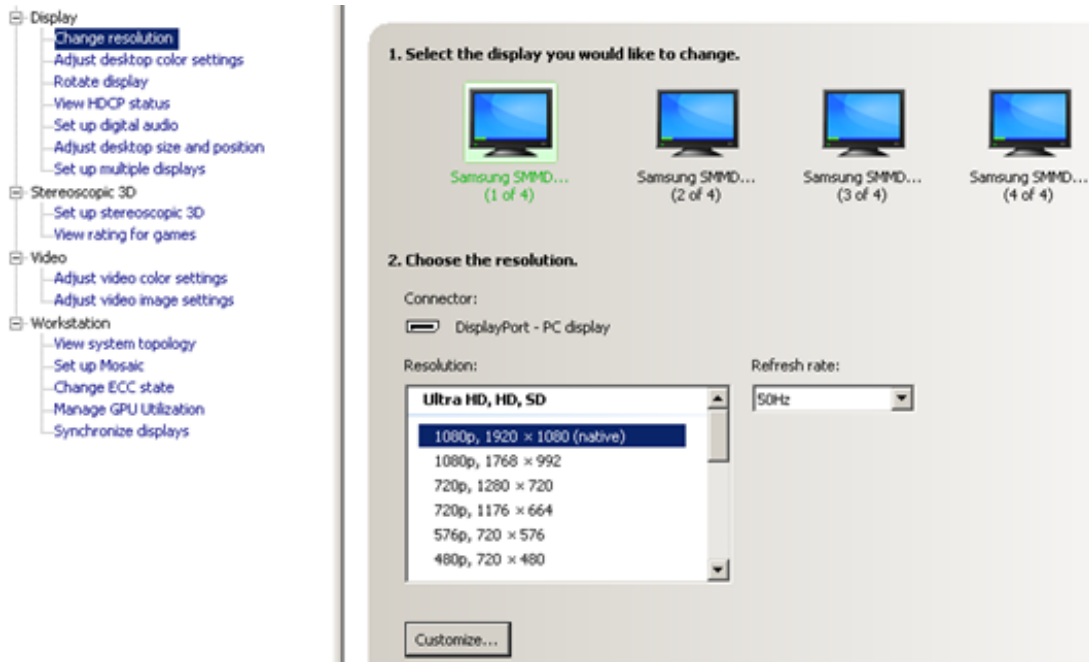

3. In the upcoming dialog, tick the **Enable resolutions not exposed by the display** check box, and click **Create Custom Resolution....**

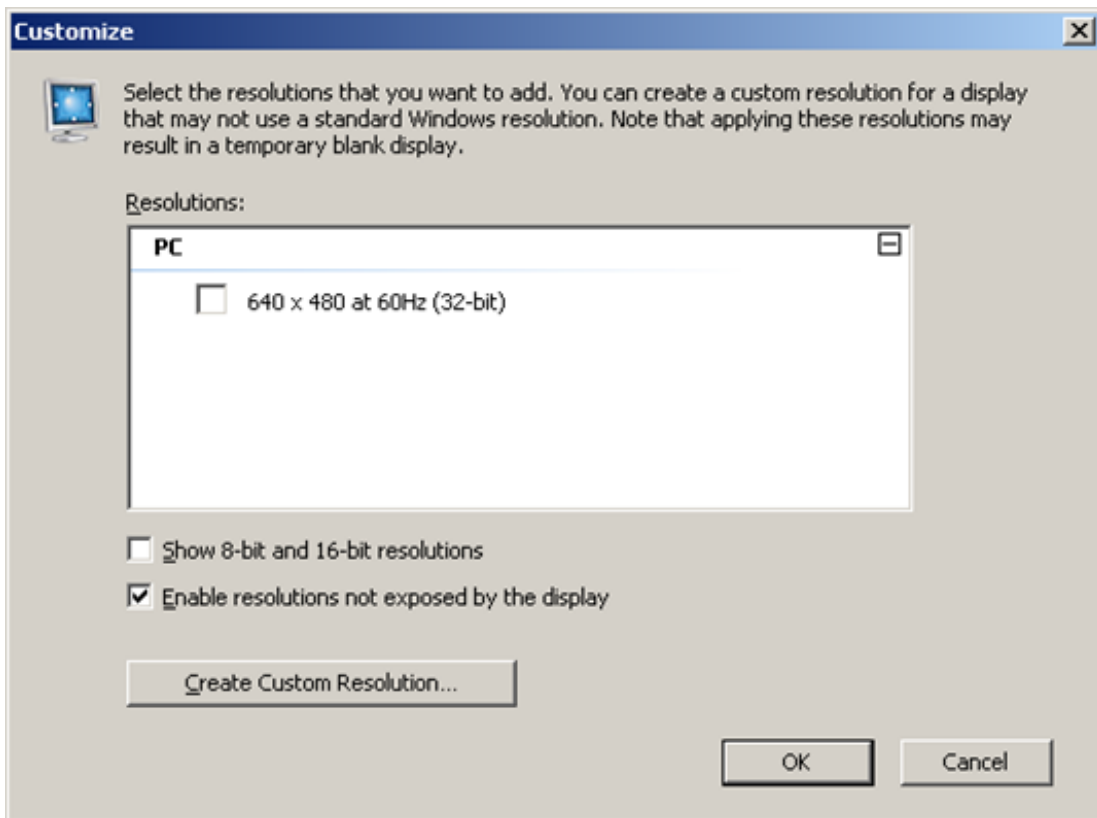

4. Select all displays in the upcoming dialog:

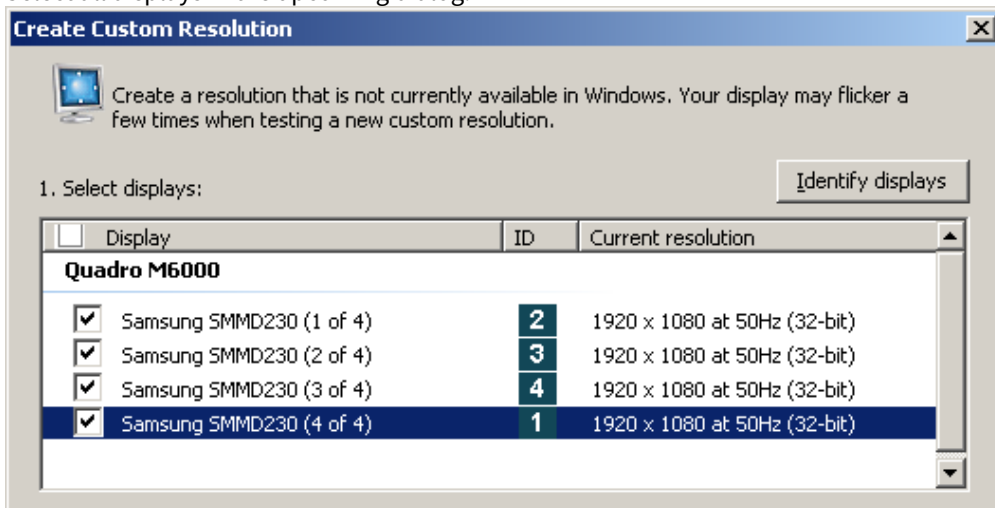

5. Enter a **Refresh rate (Hz)** of 60 Hz and leave all other settings to their default values:

2. Resolution settings: Import settings

Display mode (as reported by Windows)

Horizontal pixels:	<input type="text" value="1920"/>	Vertical lines:	<input type="text" value="1080"/>
Refresh rate (Hz):	<input type="text" value="60"/>	Color depth (bpp):	<input type="text" value="32"/>
Scan type:	<input type="text" value="Progressive"/>		

In the Timing panel, select **Manual** timing adjustment from the **Standard** drop-down list. Set the **Refresh rate** to **59.940** Hz, and leave all other settings to their respective default values:

Timing

Standard:

	Horizontal	Vertical	
Active pixels:	<input type="text" value="1920"/>	<input type="text" value="1080"/>	
Front porch (pixels):	<input type="text" value="48"/>	<input type="text" value="3"/>	
Sync width (pixels):	<input type="text" value="32"/>	<input type="text" value="5"/>	
Total pixels:	<input type="text" value="2080"/>	<input type="text" value="1106"/>	
Polarity:	<input type="text" value="Positive (+)"/>	<input type="text" value="Negative (-)"/>	
Refresh rate:	55.30 KHz	<input type="text" value="59.940"/> Hz	Pixel clock: 137.8908 MHz
		(59.000 to 61.000)	

- Click the **Test** button. The connected monitors might go black for several seconds while adjusting to the new refresh rate. Do not press any key on the keyboard or buttons on the mouse while this goes on. When the screens returns to normal, acknowledge the new settings by pressing **Yes** in the upcoming dialog.
- The newly created resolution now shows up as illustrated below and has been applied to all displays.

**✘ IMPORTANT!** Please note that for 59.94 Hz setups, the server refresh rate might report to be 60 Hz when the external house sync is 59.94 Hz. Even though the custom resolution states to be 60 Hz, the correct value under the hood is 59.94 Hz.

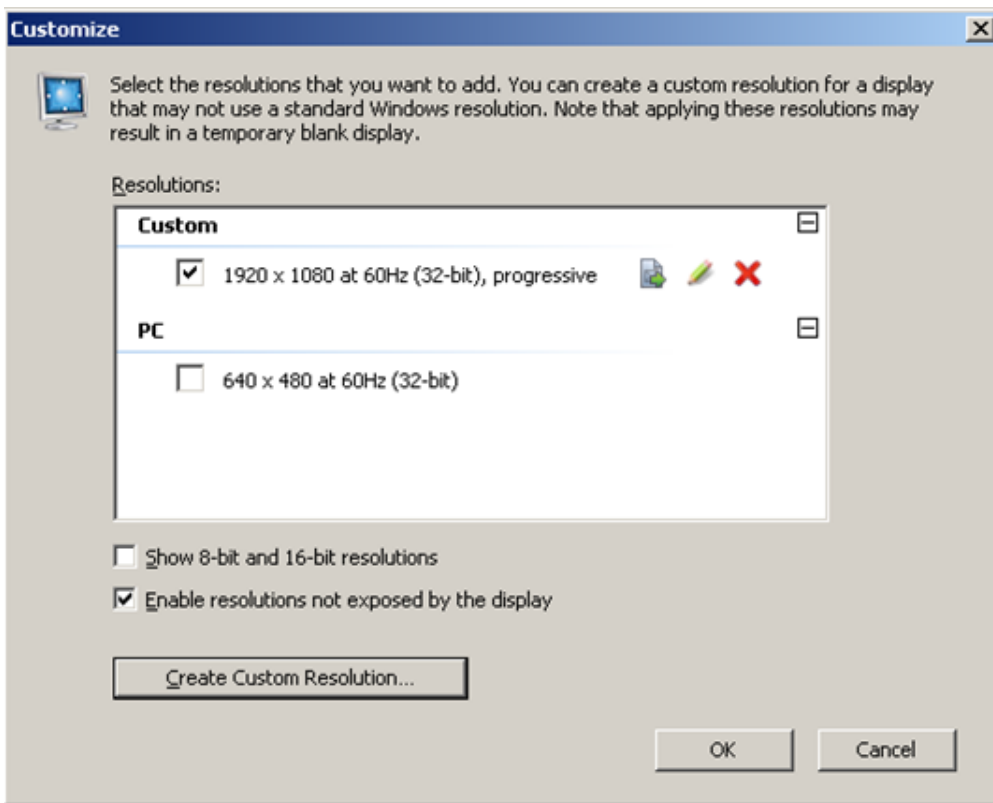

### To Change from 59.94 Hz to 50 Hz Refresh Rate

If changing the frequency from 59.94 Hz back to 50 Hz, the EDID file must be unloaded for all connected displays, followed by rebooting the machine. Otherwise, Mosaic can not be applied.

1. In the **NVIDIA Control Panel**, expand the **Workstation** section of the **Select a Task...** menu and click **View system topology**:

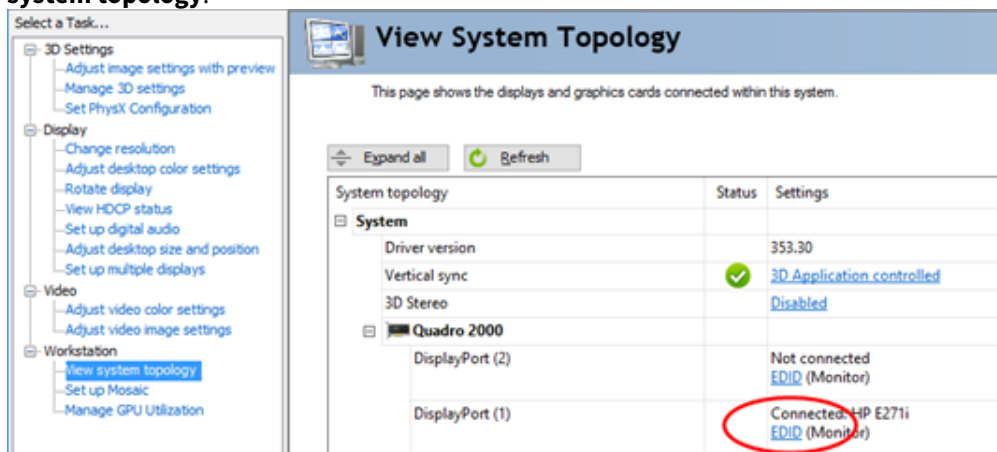

2. Click the **EDID** link on one monitor, and select the **Unload** tab.
3. Select all connected displays and click the **Unload** button.
4. Repeat the step above for all monitors one at a time.
5. Restart the computer and proceed with the [NVIDIA Mosaic Configuration for 1080i50](#).

## 14.5.9 Viz Engine Video Wall Configuration Settings

### To Configure Viz Engine for Video Wall

1. Open Viz Configuration, and create a backup of the existing configuration settings by saving them to a new file.
2. Import a configuration profile for the desired input format from the selection of [Installed Configuration Profiles](#). These ship with the Engine installation and are located in the <viz install folder>\Configuration Profiles folder. The input format files are named *video-resolution-\*.cfg*, where the asterisk represents the frame rate the configuration is suitable for.
3. Next, import a Video wall configuration profile, where the frame rate matches the one loaded for the video hardware in the previous step. As with the input format profiles, these are located in the <viz install folder>\Configuration Profiles folder. These configuration files are named *videowall-\*.cfg*, where the asterisk represents the frame rate the selected configuration file is suitable for:

```

C:\Windows\system32\cmd.exe

Directory of C:\Program Files\vizrt\Viz3\Configuration Profiles

02-Mar-16  12:06 AM                1,706 videowall-1080i25-audio.cfg
02-Mar-16  12:06 AM                1,693 videowall-1080i25-video-audio.cfg
02-Mar-16  12:06 AM                1,789 videowall-1080i25.cfg
02-Mar-16  12:06 AM                1,707 videowall-1080i30M-audio.cfg
02-Mar-16  12:06 AM                1,693 videowall-1080i30M-video-audio.cfg
02-Mar-16  12:06 AM                1,790 videowall-1080i30M.cfg
               6 File(s)              10,378 bytes
               0 Dir(s) 84,284,010,496 bytes free

C:\Program Files\vizrt\Viz3\Configuration Profiles>_

```

4. Adjust the [Output Format](#) in Viz Config:
  - Verify that *Fullscreen* is the selected format in the output format specification list. The output format MUST be *Fullscreen* and not *User Defined*. Only **Fullscreen** and **Videowall mode on** forces the engine to go into Videowall Mode.
  - The frame rate should have been set when loading the *videowall-\*.cfg* configuration profile in step two. Ensure that the correct values are set for the required output. For PAL systems, set the **Frame** value to `50`. For NTSC systems, set the **Frame** value to `59.94`.
  - Set the **Aspect** value to the aspect ratio of the video wall. The aspect ratio decimal value is found by dividing the number of pixels, width by height. This value depends on the actual video wall display layout and needs to be adjusted if changes to the display layout are made.



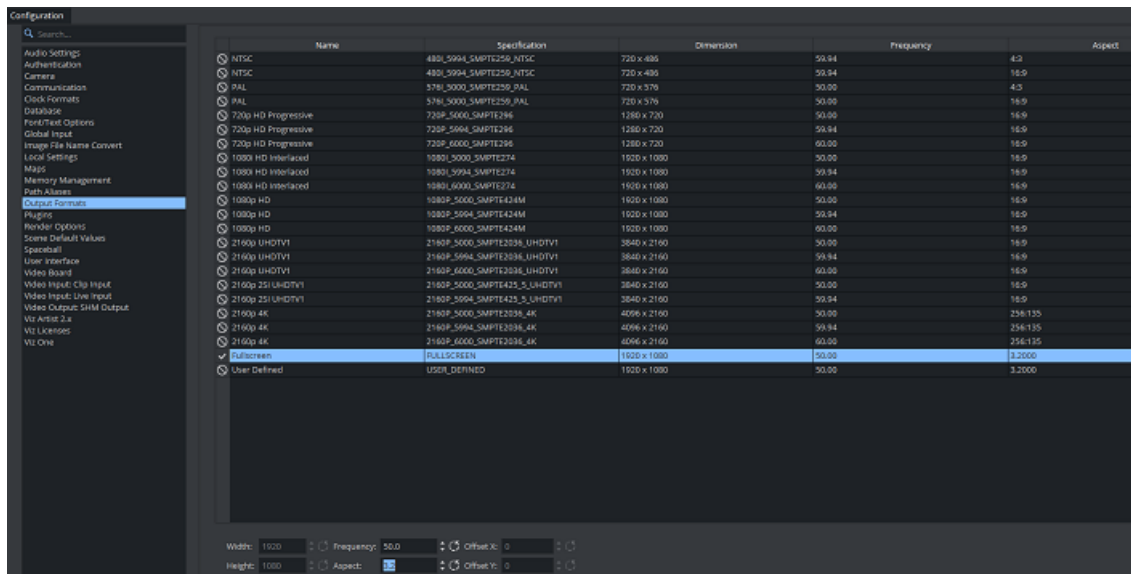

- Verify the following Video Output settings:
  - Video wall/Multi-display** should be set to Active.
  - Click the **Show Video Output Config. Editor** button and verify that the required Genlock is set. For configurations with the Matrox X.Mio3 video board, Genlock must be set to **Auto**. Other configurations can be set to **Auto**, **Blackburst** or **Tri-Level**, as required.
- Under **Render Options**, disable **On Air Mouse Cursor**.
- In the Video Input section, enable the required number of **Live** and **Clip Channel** sources. Unused live inputs should be deactivated, as activating them could have an impact on performance.
- Manually edit the configuration file, and set the flag `use_threaded_io` to `1`.
- In the **Database** section, specify which Viz Graphic Hub to use and provide the login credentials.
- Start Viz Engine without a User Interface, by executing the following command from the command line: `<viz install folder>\viz.exe -n -w`.

**IMPORTANT!** On Windows 10, it might happen that Viz renders at half the speed (25fps) and renders full speed if the focus is on another window. In this case, change the startup parameter to `<viz install folder>\viz.exe -n -y`.

- Load a scene containing a single live-video or clip source as a texture and scale it up to full screen. If running Viz Artist, switch to **On Air Mode**. Watch for drops in the video wall output within the first 60 seconds.
- Verify the configuration of the NVIDIA driver by checking the Topology Inspector, and check the Viz Engine configuration. This is especially important when setting up a 59.94 Hz video-wall, as a wrong refresh-rate of 60 Hz could get applied to the displays by mistake.
- In general, a proper Mosaic setup is automatically synchronized with Viz Engine. However, it can be necessary to force Viz Engine to synchronize. This is necessary for all setups with multiple graphics cards. To force synchronization, issue the following command in the Engine Console: `send RENDERER JOIN_SWAPGROUP 1`.

**IMPORTANT!** Do not execute this command unless needed, as this may have an impact on performance.

14. If the computer is rebooted or Viz Engine restarted, the command needs to be sent again. To avoid doing this manually every time the Engine starts, set the `swapgroup` value in the **RENDER\_OPTIONS** section of the configuration file to `1`. The default value is `0`.

 **Tip:** This synchronization can also remedy certain tearing effects. Create a simple scene with a bar running left to right. If any of the connected monitors display tearing effects, try sending the above command.

## Audio Output

For performance reasons, in a Video Wall setup the video out channels are usually set to **Unused**. To configure a Video Wall with embedded or AES audio output, the video out channel must be mapped to the selected Matrox channel. Set **Map to Viz Channel** in the [Matrox VideoOut Properties](#) in Viz Configuration.

 **Note:** When running a Video Wall with audio out, even though the video out channel is mapped, the SDI output is black.

It is highly recommended to not use the audio output of the installed video board. Audio can usually also be grabbed from one of the HDMI/Display Port connectors of the NVIDIA board.

## NDI

Please note, that NDI input is currently not tested on videowall setups.

---

## 15 SNMP Support

**Information:** Microsoft has deprecated SNMP on Windows 10 build 1809. It is unknown how long this feature will be supported by Viz Engine.

---

### 15.1 Introduction

SNMP (Simple Network Management Protocol) is a standard, usually UDP based protocol used for collecting information about managed services over IP networks. The device can send notifications (traps) on important state changes.

All values are addressed using a dotted notation string which is represented by a tree structure. The Vizrt registered subtree is 1.3.6.1.4.1.27566. followed by a unique identifier for different products like Viz Engine (1) or Viz Graphic Hub (2). The subtree for instance one of a Viz Engine would be 1.3.6.1.4.1.27566.1.1. It then splits up into a data part (1) and SNMP compliance mandatory structures (2).

The SNMP Extension is a DLL, an extension for the built-in Windows SNMP service. The agent (one per DLL) provides data to the service which can be retrieved by the SNMP protocol. The agent can also trigger sending SNMP traps (notifications). The service runs as LocalSystem user. The current SNMP version supported is 2c. Version 2c is the most common standard. Version 1 is obsolete, version 3 is not yet, if ever, supported by Microsoft.

---

### 15.2 Installation

#### 15.2.1 Prerequisites

Before installing the SNMP Extension, the Windows SNMP service has to be installed and configured. This is usually a part of the workstation or server operating system. It has been tested using Windows 7 and Windows 10.

#### 15.2.2 To Install the Services

- Open the **Control Panel**.
- Select **Programs and Features**, then **Turn Windows Features On or Off** list in **Control Panel > Programs and Features**.

**Information:** SNMP is missing from Windows features in Windows 10 Professional Build version 1809. There is a temporary fix for this:

1. Open Powershell with Administrator credentials and enter the following command:

```
Get-WindowsCapability -Online -Name "SNMP*"
```

Shows *Not Present*.

2. Enter the following command:

```
Add-WindowsCapability -Online -Name "SNMP.Client~~~~0.0.1.0"
```

```
Get-WindowsCapability -Online -Name "SNMP*"
```

Now shows *Installed*.

The feature still does not show in the Windows Features window, but the service is installed and configurable from *services.msc*.

- Select the **Simple Network Management Protocol (SNMP)**, the subfeature *WMI SNMP Provider* is not being used.

You'll find it afterwards in **Computer Management > Services**.

- On Tab **Security**
  - Click **Add** to **Accepted community names**.
  - Enter `public` to the **Community** name.
  - Set the Community right to **READ ONLY**.
- On tab **Traps** enter:
  - Community name: `public`.
  - Possible trap destinations `127.0.0.1`.

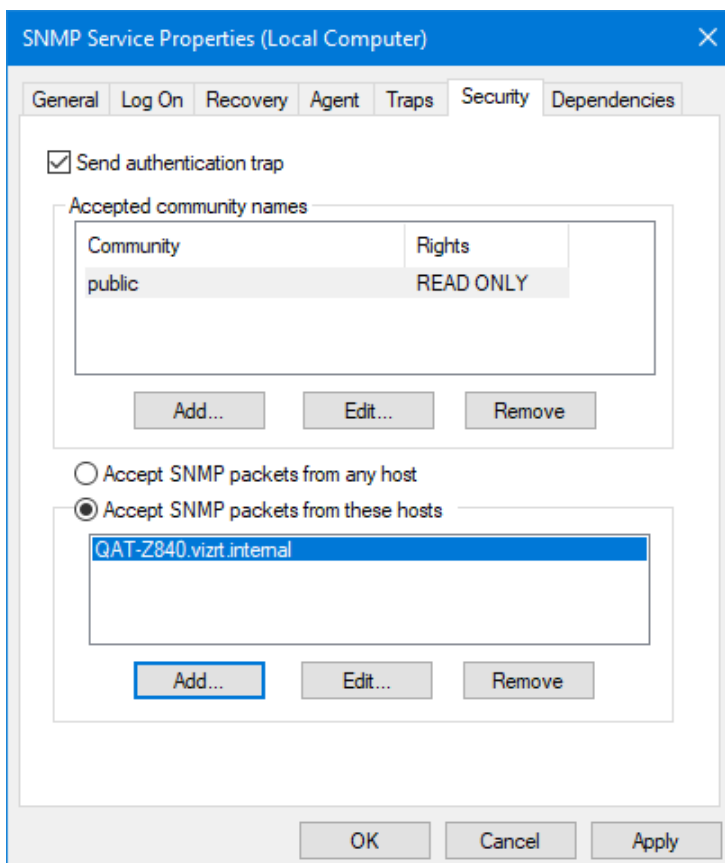

**Note:** If you want to have active trap notifications, you have to enter the IP destination of your host monitoring system into the trap destinations as the SNMP service forwards the notifications to the monitoring host.

Without the configuration above, the SNMP service appears to be running, but does not send anything and the queries time out.

### 15.2.3 Installation

Currently there are two DLLs, one for Viz Engine (*VizEngineSnmExt.dll*) and one for Viz Graphic Hub (*VizGraphicHubSnmExt.dll*). During installation, these files are copied to your hard drive and the DLLs are registered in the registry in:

Path	Setting
<i>Computer\HKEY_LOCAL_MACHINE\SYSTEM\CurrentControlSet\Services\SNMP\Parameters\ExtensionAgents</i>	"0"="SOFTWARE\vizrt\VizEngineSnmExt\CurrentVersion"
<i>Computer\HKEY_LOCAL_MACHINE\SOFTWARE\vizrt\VizEngineSnmExt\CurrentVersion</i>	"Pathname"="C:\Program Files\Vizrt\VizEngine\SNMP\VizEngineSnmExt.dll"

 **Note:** The number of registered services (in the table above is "0") may vary based on the previously registered services sequence.

### 15.2.4 Configuration

The extension agents were designed to have as few configuration options as possible. The parameters are located in registry and are read when the agent is initialized. The registry location for Viz Engine is *HKLM\SOFTWARE\vizrt\VizEngineSnmExt*. All parameters are optional. By fulfilling some setup conditions it is possible to install the agents without needing to use the parameters at all.

Registry Key	Default Value	Info
DebugLog	0	Enables debug log level. The log is located at <i>C:\ProgramData\Vizrt\SNMPExtAgents</i> . It should be disabled in production environment.
SampleTime	5000	Sample time in milliseconds for fetching the latest data, from Graphic Hub over REST, for example.
TrapRepeat	36	The agents repeat traps for values in „failed“ condition. The repeat time is $SampleTime * TrapRepeat$ . Set to 0 to turn off trap repeating.
TrapHandling	1	Set to 0 to disable sending traps entirely. It is suggested to rather ignore the traps in the monitoring system than disabling them entirely.

### 15.2.5 Viz Engine Specific Settings

- Engine config flag *shm\_system\_status\_enabled* should be set to 1.
- When multiple engine instances are monitored, create a new string value registry entry in `Computer\HKEY_LOCAL_MACHINE\SOFTWARE\vizrt\VizEngineSnmpExt`, *Value name* = `ChannelCount`, *Value data* = [number of engine instances].