



# Datacenter User Guide

Version 2.2



**Copyright** ©2024 Vizrt. All rights reserved.

No part of this software, documentation or publication may be reproduced, transcribed, stored in a retrieval system, translated into any language, computer language, or transmitted in any form or by any means, electronically, mechanically, magnetically, optically, chemically, photocopied, manually, or otherwise, without prior written permission from Vizrt.

Vizrt specifically retains title to all Vizrt software. This software is supplied under a license agreement and may only be installed, used or copied in accordance to that agreement.

### **Disclaimer**

Vizrt provides this publication “as is” without warranty of any kind, either expressed or implied. his publication may contain technical inaccuracies or typographical errors. While every precaution has been taken in the preparation of this document to ensure that it contains accurate and up-to-date information, the publisher and author assume no responsibility for errors or omissions. Nor is any liability assumed for damages resulting from the use of the information contained in this document. Vizrt’s policy is one of continual development, so the content of this document is periodically subject to be modified without notice. These changes will be incorporated in new editions of the publication. Vizrt may make improvements and/or changes in the product(s) and/or the program(s) described in this publication at any time.

Vizrt may have patents or pending patent applications covering subject matters in this document. The furnishing of this document does not give you any license to these patents.

### **Antivirus**

Vizrt does not recommend or test antivirus systems in combination with Vizrt products, as the use of such systems can potentially lead to performance losses. The decision for the use of antivirus software and thus the risk of impairments of the system is solely at the customer's own risk.

There are general best-practice solutions, these include setting the antivirus software to not scan the systems during operating hours and that the Vizrt components, as well as drives on which clips and data are stored, are excluded from their scans (as previously stated, these measures cannot be guaranteed).

### **Technical Support**

For technical support and the latest news of upgrades, documentation, and related products, visit the Vizrt web site at [www.vizrt.com](http://www.vizrt.com).

### **Created on**

2024/10/24

# Contents

<b>1</b>	<b>Introduction .....</b>	<b>6</b>
1.1	Feedback .....	7
1.2	Support.....	7
<b>2</b>	<b>Overview.....</b>	<b>8</b>
2.1	Accessing Datacenter.....	8
2.2	Datacenter Main Entities .....	8
2.3	The Datacenter Main Page.....	9
<b>3</b>	<b>Requirements.....</b>	<b>11</b>
3.1	Applications.....	11
3.2	User Permissions.....	11
3.2.1	Read and Write Access .....	11
3.3	Ports.....	12
<b>4</b>	<b>Admin System Configurations.....</b>	<b>13</b>
4.1	Configuring Datacenter .....	14
4.1.1	Providers Configuration.....	16
4.1.2	General Configuration .....	23
4.2	Configuring Outputs .....	30
4.2.1	Viz Engine Configuration .....	31
4.2.2	Viz Libero Configuration .....	34
4.2.3	Viz Arena Configuration .....	35
4.2.4	Viz Arc Configuration.....	36
<b>5</b>	<b>Operating Datacenter .....</b>	<b>37</b>
5.1	Getting Started.....	38
5.2	Accessing Datacenter.....	39
5.2.1	Accessing Datacenter.....	39
5.3	Creating Datasets.....	40
5.3.1	Creating a Dataset.....	40
5.3.2	Tagging a Dataset.....	41
5.3.3	Duplicate an Existing Dataset.....	41
5.3.4	Disabling or Deleting a Dataset .....	42
5.3.5	Monitoring a Dataset State.....	43
5.4	Configuring Datasets .....	45
5.4.1	Supported Providers.....	47

- 5.4.2 Filtering and Manipulating a Dataset Entries .....107
- 5.4.3 Enabling or Disabling Dataset Entries..... 124
- 5.4.4 Inspecting Dataset Entries.....126
- 5.4.5 Working with Live Data: the Performance Dashboard ..... 131
- 5.4.6 Joining Endpoints Parameters .....135
- 5.5 Outputs ..... 141
  - 5.5.1 Overview .....141
  - 5.5.2 Add and Edit an Output .....141
  - 5.5.3 Disable an Output .....142
  - 5.5.4 Viz Engine Output.....144
  - 5.5.5 Viz Arc Output.....158
  - 5.5.6 Generic TCP Output .....159
- 6 Alternative Views..... 161
  - 6.1 Simple Page..... 162
  - 6.2 Configurable Page..... 163
- 7 Third-Party Licenses ..... 165
  - 7.1 ASP.NET Core ..... 166
  - 7.2 Confluent Kafka for .NET ..... 167
  - 7.3 Coverlet ..... 172
  - 7.4 JUnitTestLogger..... 173
  - 7.5 moq4..... 174
  - 7.6 NJsonSchema for .NET ..... 175
  - 7.7 Node.js..... 176
  - 7.8 npm..... 215
    - 7.8.1 npm packages MIT .....219
  - 7.9 Sep ..... 226
  - 7.10 Serilog..... 227
  - 7.11 Serilog Graylog Sink..... 231
  - 7.12 SportzCast Library ..... 232
  - 7.13 Swashbuckle.AspNetCore ..... 233
  - 7.14 Vite ..... 234
  - 7.15 WixSharp..... 235
  - 7.16 xunit ..... 236



# 1 Introduction

Datacenter is an end to end solution that allows you to connect live data sources to fields in your graphics, without the need of any special knowledge of the data at hand.

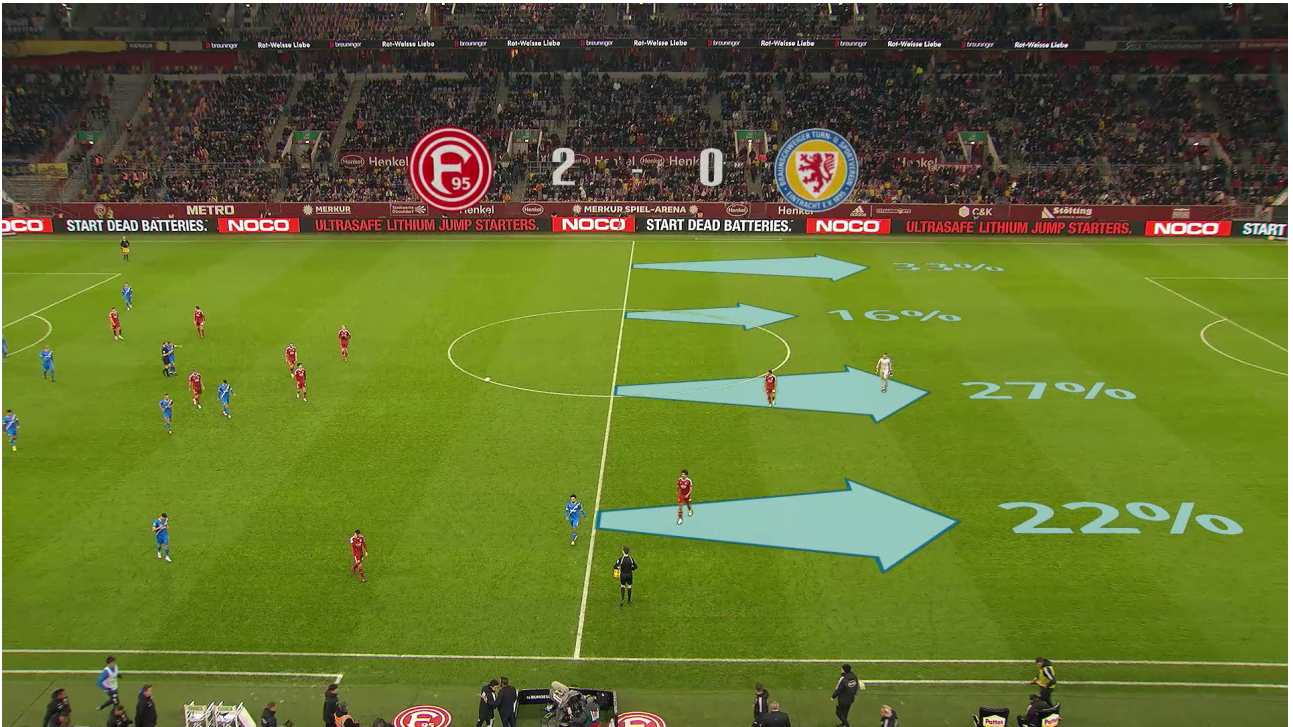



Therefore, Datacenter acts as the gateway between data providers and the Viz ecosystem, automatically translating data coming from heterogeneous sources to format(s) understood by various Viz applications.

Its main purpose is to connect incoming live data, whether from a local source or an online data provider, to fields in your scenes, handling updates in real time. It is ideal to connect to, for instance, a scoreboard on a venue to clock-and-score graphics, or scene effects to data updating in real time.

---

## 1.1 Feedback

We welcome your feedback on Vizrt products and documentation. Please contact your local Vizrt customer support team at <http://www.vizrt.com>.

---

## 1.2 Support

Support is available at the [Vizrt Support Portal](#).

For more information about all Vizrt products, visit:

- [www.vizrt.com](http://www.vizrt.com)
- [Vizrt Documentation Center](#)
- [Vizrt Training Center](#)
- [Vizrt Forum](#)

## 2 Overview

### 2.1 Accessing Datacenter

Datacenter runs automatically as a service on the host machine. It automatically starts on Windows startup, and its status can be monitored in **Task Manager > Services > VizrtDataCenter**.

While the service is always running in the background, the main user interface can be opened using a browser on the same machine hosting the service, using one of the following addresses:

- <http://127.0.0.1:5700>. This address is always available, regardless of the service mode being configured (see [HTTPS Certificate](#) configuration).
- <https://127.0.0.1:5701>. This address is only available if a valid HTTPS certificate has been configured (see [HTTPS Certificate](#) configuration).

If Datacenter is correctly configured to run an HTTPS backend that listens to all network interfaces, then the user interface is also reachable from:

- <https://<host-machine-ip>:5701>, where *<host-machine-ip>* is the public IP of the host machine. This mode allows you to reach and monitor Datacenter from all machines in the same network, for example.

**Info:** The Admin page is only accessible when the Datacenter user interface is reached using the localhost address option.

### 2.2 Datacenter Main Entities

Datacenter connects data **Providers** to application **Outputs**, organizing the data flow into separate and editable **Datasets**. Specifically:

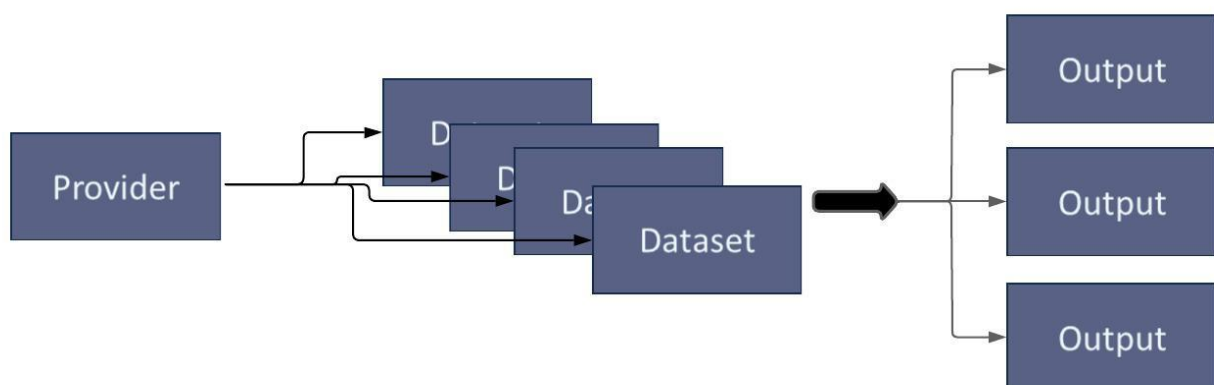

- A data **Provider** represents a data source to which Datacenter connects to. It can be a local (for example, a file) or a remote resource (for example, a server), and its unique (there is only one Provider of type File).



- A **Dataset** represents a collection of data entries from a specific Provider. It is created by the user, and there is no limit to the number of datasets of a specific provider that can exist. Each dataset holds one or more data entries, all coming from the same provider resource.
- An **Output** represents the sending end of the Datacenter data flow. There exists a finite number of output types (for example, Viz Engine or Viz Arc), but there is no limit to the number of instances.

## 2.3 The Datacenter Main Page

The Datacenter main user interface consists of six sections:

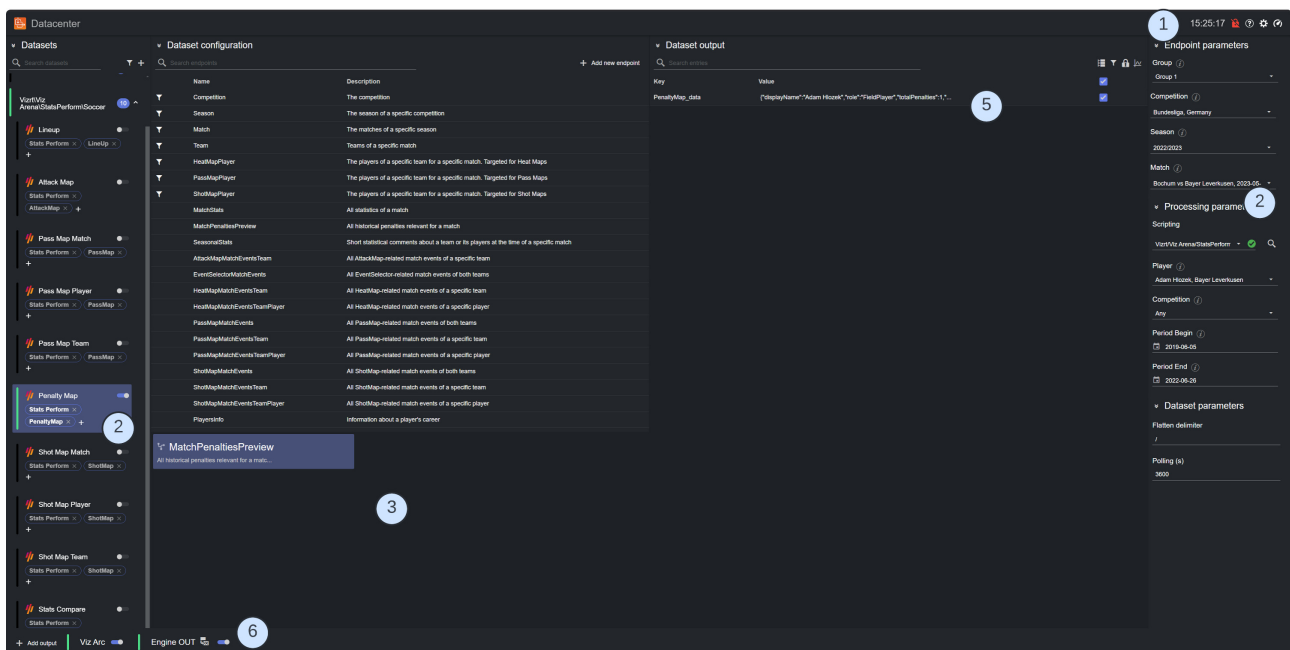

1. **Application Bar:** Use this section to access the **Admin** page (⚙️), check the status of the service, as well as the service HTTP(s) mode (🔥), and limit the refresh rate of the UI (🔄). The Documentation can also be opened from the status bar (❓).
2. **Datasets pane:** Where all the configured datasets are listed. A dataset can be selected with its status shown on the status line on the left, and toggled off from here. Its entry can also be cloned to create a second independent dataset.
3. **Dataset Configuration pane:** In the configuration pane a new dataset can be configured or an existing one edited. Specifically, a dataset source or a provider specific element can be selected in the configuration pane and edited in the Settings Editor. This view changes according to the Provider being used.
4. **Settings Editor:** Edit specific provider elements or a dataset source parameters (for example, endpoint parameters or refresh rate for a source). This view is dynamic and adapts according to the Provider being used and the element being selected in the Dataset Configuration pane.
5. **Dataset Output pane:** In this section, the key and value pairs that belong to the currently selected dataset are shown. These values are available in the configured output, they can be toggled, flattened or merged, and in the case of Manual Provider, values can be edited or keys added/removed.
6. **Viz Outputs footer:** The configured outputs for the incoming data are configured and listed here. Click on an output name to open the edit dialog, the output status is shown on the status line on the left, while the toggle can switch an output ON/OFF.

**Info:** While limiting the refresh rate of the UI, the corresponding button in the Application Bar is shown in yellow .

## 3 Requirements

### 3.1 Applications

Datacenter integrates with various Vizrt applications, each with the following requirements:

Application	Version
Viz Engine	4.4.1 or newer
Viz Libero	8.2.0 or newer
Viz Arena	5.3.0 or newer
Viz Arc	1.7.0 or newer

Datacenter has been tested using the following browsers:

Browser	Version
Google Chrome	130.0.6723.60
Brave	1.71.144
Firefox	131.0.3

### 3.2 User Permissions

#### 3.2.1 Read and Write Access

The user running the Datacenter requires read and write access to the following path locations:

Path	Read Access	Write Access
Folder: <i>C:\ProgramData\vizrt\*</i>	required	required
Folder: <i>C:\Program Files\vizrt\*</i>	required	<b>Only during installation</b>
*Indicates all subfolders		

### 3.3 Ports

Target Port	Protocol	Type	Feature	Required	Comment
<code>P</code> (see "Required")	UDP	inbound	Core	When creating a dataset of type Socket Listener UDP listening on port <i>P</i> .	Used to receive data.
<code>P</code> (see "Required")	TCP	inbound	Core	When creating a dataset of type Socket Listener UDP listening on port <i>P</i> .	Used to receive data.
<code>P</code> (see "Required")	UDP	outbound	Core	When creating an output of type Viz Engine sending to port <i>P</i> .	Used to send data via UDP.
<code>P</code> (see "Required")	TCP	outbound	Core	When creating an output of type Socket Connector connecting to host on port <i>P</i> .	Used to initiate data streaming via TCP.
<code>P</code> (see "Required")	TCP	outbound	Core	When creating an output of type Viz Arc or Generic TCP sending to port <i>P</i> .	Used to send data via TCP.
<code>5700</code>	TCP	inbound	Core	Always	Main backend on HTTP.
<code>5701</code>	TCP	inbound	Core	Always	Main backend on HTTPS.
<code>443, 37718</code>	TCP	outbound	Core	When creating a dataset of type Tracab.	Used to receive data.

**Info:** If the "Stream Port" parameter in the Tracab Provider configuration is changed from the default one ( `37718` ), then the user must ensure that there is no outbound firewall restriction on the newly setup port.

---

## 4 Admin System Configurations

This section provides information on how to configure the system running the Datacenter, which includes:

- [Configuring Datacenter](#)
- [Configuring Outputs](#)

## 4.1 Configuring Datacenter

Datacenter runs as a Windows service, and it starts automatically on startup. The main UI can be accessed by navigating to <http://127.0.0.1:5700>.

If Datacenter is started as an HTTPS service, the UI is reachable at (please note the change of port number):

- <https://127.0.0.1:5701>
- <http://<computer-name>:5701> where <computer-name> is the name registered in the configured HTTPS certificate for your machine. More information on how to configure a secure HTTPS service can be found in the [General Configuration](#).

When accessing Datacenter via localhost (the same host that runs the Datacenter service, which also corresponds to the 127.0.0.1 IP address), you can also access the Admin page where a variety of options can be configured. The Admin page can be reached using one of these options:

- Navigating to <http://127.0.0.1:5700/admin> (or alternatively <https://localhost:5701/admin>).
- By clicking on the cogwheel icon  in the main page UI.

When opening the Admin page, the following window is shown:

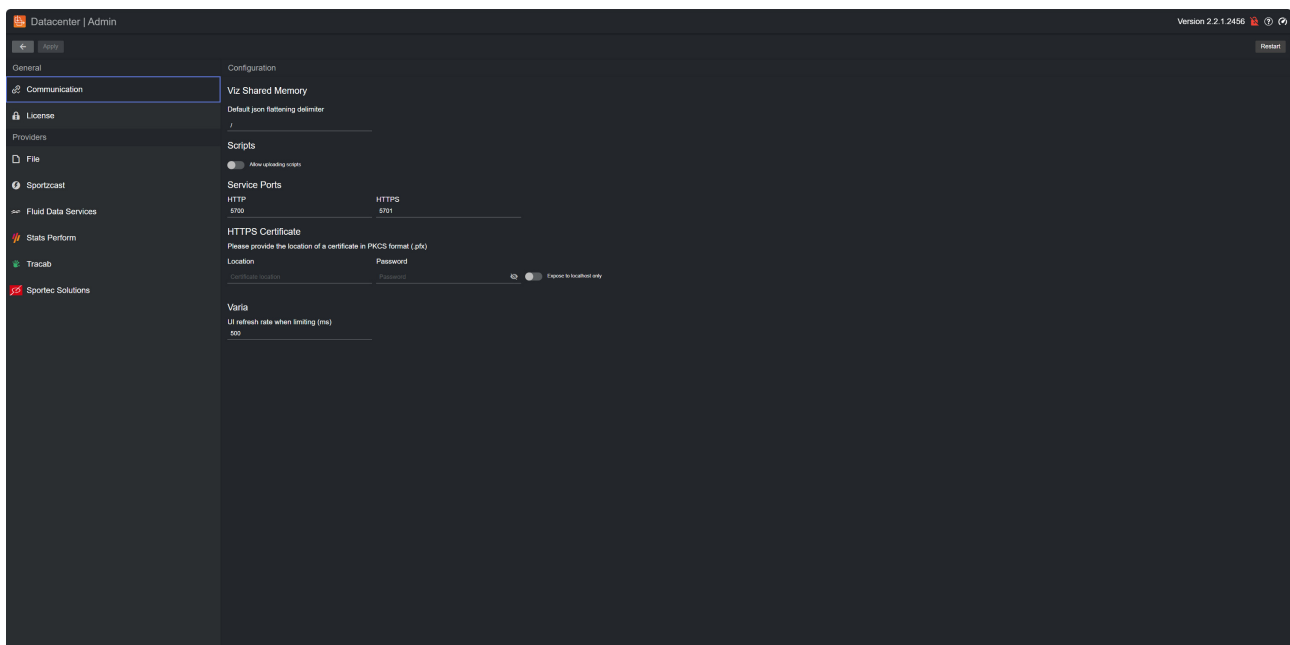

**Note:** The Datacenter Admin page can only be accessed via localhost. To confirm it can be accessed, please make sure the cogwheel icon  is present in the top-right corner of the Datacenter Main page.

**Info:** Changes made in the Admin page are not automatically applied. To apply any change made to the configuration, please make sure to press the **Apply** button in the top-left corner of the UI .

**Info:** To restart the Datacenter service, please press the **Restart** button in the top-right corner of the UI . A dialog appears where you can confirm whether to restart the service or not. After confirming, the Datacenter service is restarted immediately, **causing the sending of output data to temporary stop**.

This section describes how to configure various aspects of the Datacenter, including:

- [Providers Configuration](#)
- [General Configuration](#)

## 4.1.1 Providers Configuration

Datacenter supports a variety of data Providers. Some of them have a global configuration that needs configuring.

This section explains how to use such configurations:

- [File](#)
- [Sportzcast](#)
- [Fluid Data Services](#)
- [Stats Perform](#)
- [Tracab](#)
- [Sportec Solutions](#)

### File

The Datacenter can be configured to read files from specific input folders. To be able to open and monitor files on these locations, those folders need to be added to the File provider configuration using the following steps:

1. Click on the **File** entry in the Provider list in the Admin page.
2. Click on the plus button **+**.
3. Type the path in the **Folder Path** input field.
4. Enter an alias for this path to be used in the application.
5. Click the **Apply changes** button.

The alias submitted points to the specified folder path when used to create new datasets of type File.

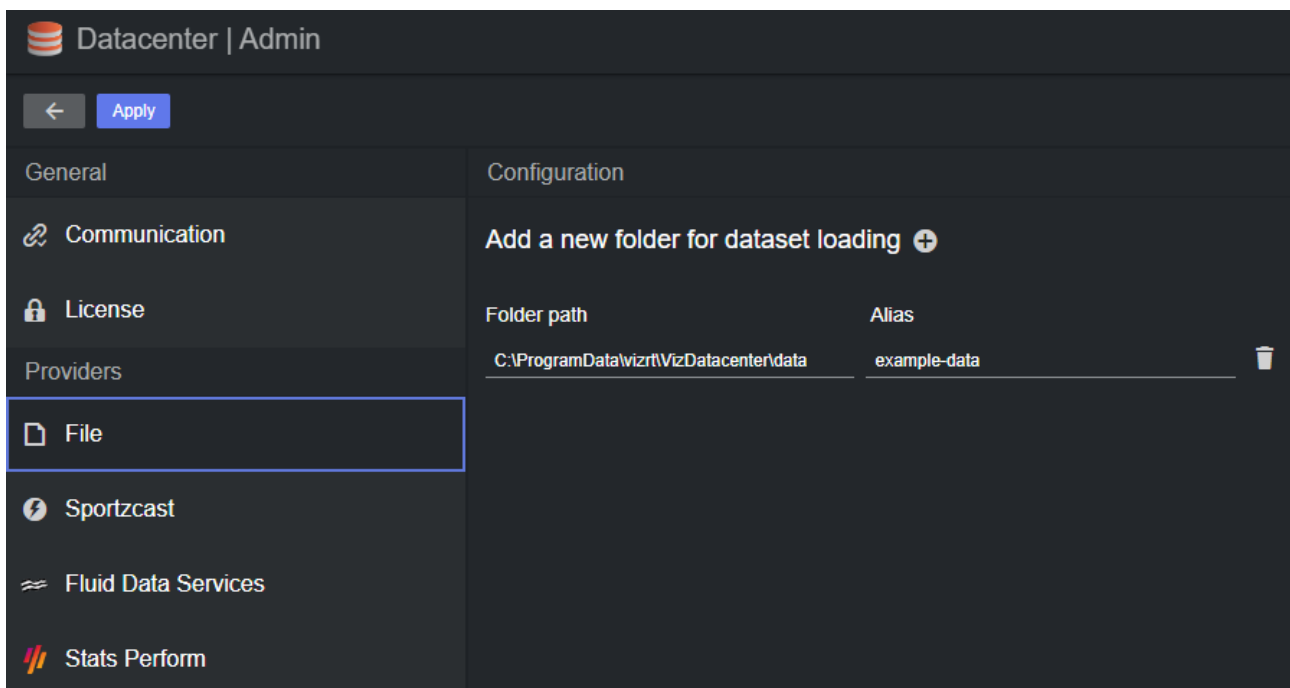

**Note:** For security reasons, the folders and files to be used in Datacenter can only be accessed when copied to `C:\ProgramData\vizrt\VizDatacenter`.



**Note:** Datacenter ships with example files that can be used to test a File provider. They are located in C: \ProgramData\vizrt\VizDatacenter\Data\Files.

## Sportzcast

Datacenter can be configured to fetch data from the [Sportzcast by Genius Sports](#) cloud service. Such service requires a username and password that must be obtained from the data Sportzcast.

To be able to fetch data from the [Sportzcast by Genius Sports](#) cloud service, the following configurations must be performed:

- **Username:** The username obtained by the Sportzcast data provider.
- **Password/Token:** The password (sometimes referenced as token) obtained by the Sportzcast data provider.
- **Server:** The hostname of the provider (use the default [scorebot.sportzcast.net](#) for the default service, or your own server location).
- **Port:** The port used to communicate with the host configured (default: 1402).
- **Test configuration:** Use this button to test whether the specified configuration is correct. If correct, the button turns green, otherwise it turns red. Hovering over the button reveals the error in a tooltip:

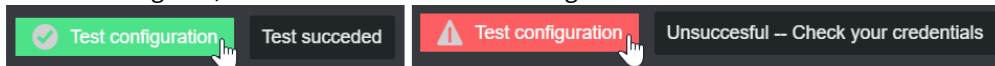

## Fluid Data Services

Datacenter can be configured to fetch data from the [Fluid Data Services](#) data provider. For this integration to work, the following configurations must be performed:

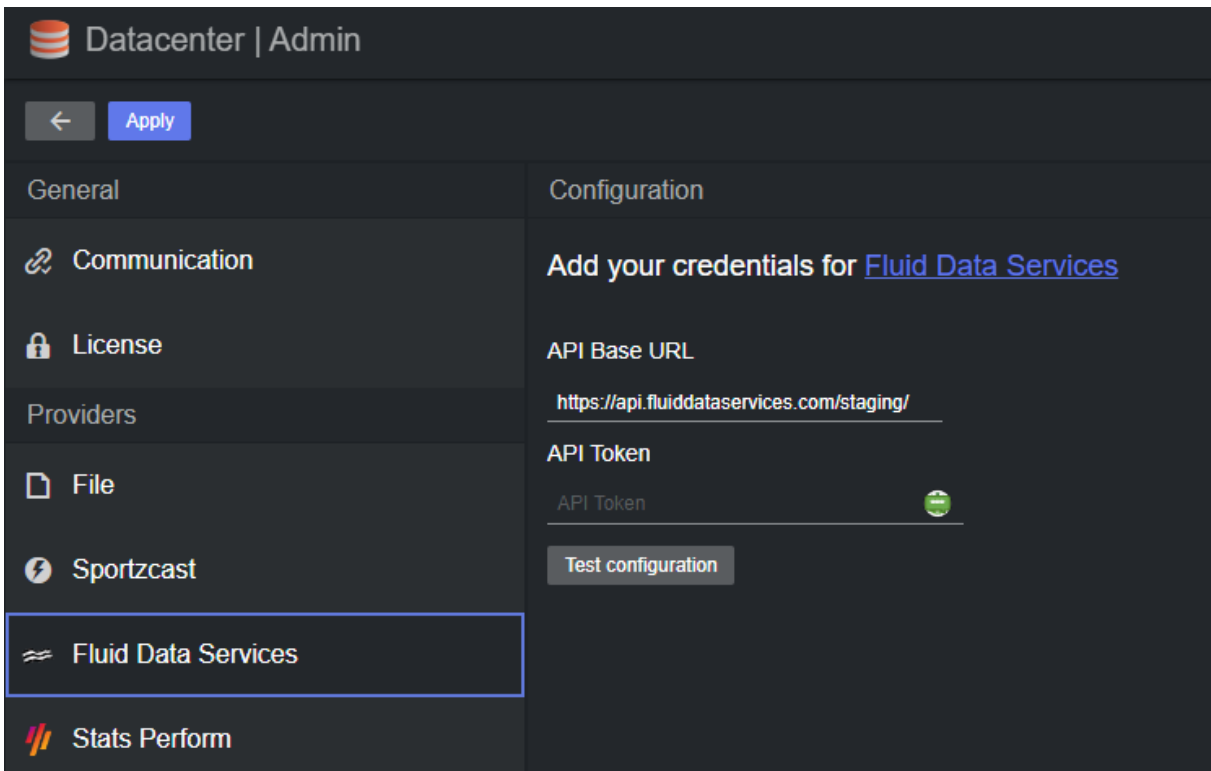

- **API Base Url:** The URL used to fetch data from the desired endpoints (for example, <https://api.fluiddataservices.com/staging/>).
- **API Token:** This input field is to specify the API token required to authenticate with the Fluid Data Services backend. The token must be obtained directly from the provider. When saved, the token is encrypted and its encrypted value is shown rather than the plain value (it is used when issuing HTTP(s) requests to the webserver).
- **Test configuration:** Use this button to test whether the specified configuration is correct. If correct, the button turns green, otherwise it turns red. Hovering over the button reveals the error in a tooltip:

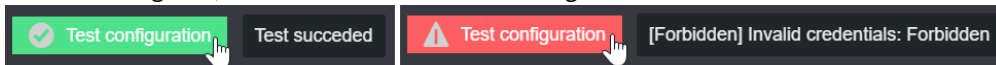

## Stats Perform

Datacenter can be configured to fetch data from the [Stats Perform](#) data provider. For this integration to work, the following configurations must be performed:

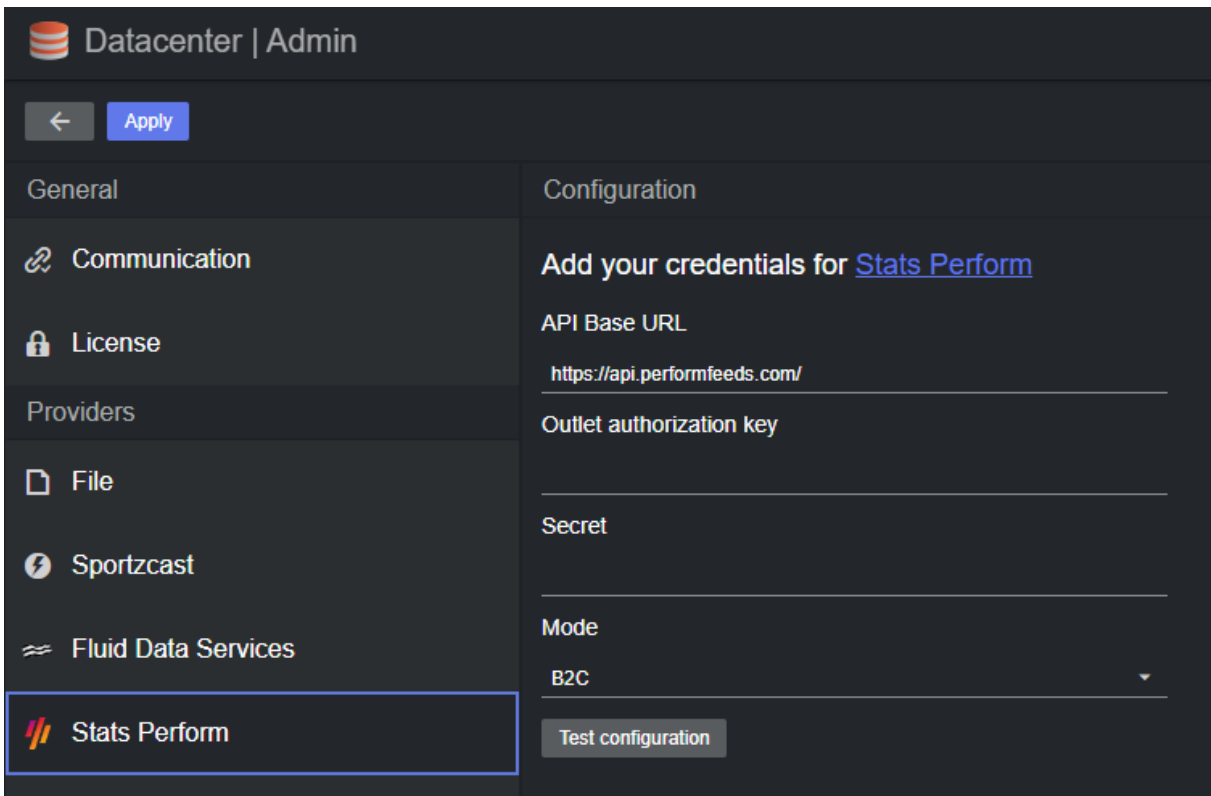

- **API Base URL:** The URL used to fetch data from the desired endpoints, needs to be configured to [api.statsperform-hosted.com.cn](https://api.statsperform-hosted.com.cn) when using the integration from a Chinese IP or domain.
- **Outlet authorization key:** Authorization key provided by StatsPerform.
- **Secret:** Secret provided by StatsPerform (if needed, depending on the account type).
- **Mode:** Business-to-Business (**B2B**) or Business-to-Customer (**B2C**), depends on the account type.
- **Test configuration:** Use this button to test whether the specified configuration is correct. If correct, the button turns green, otherwise it turns red. Hovering over the button reveals the error in a tooltip:

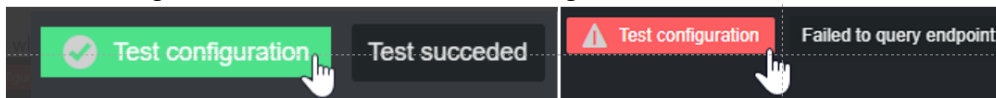

## Tracab

Datacenter can be configured to receive data from the [Tracab](#) data provider. For this integration to work, the following configurations must be performed:

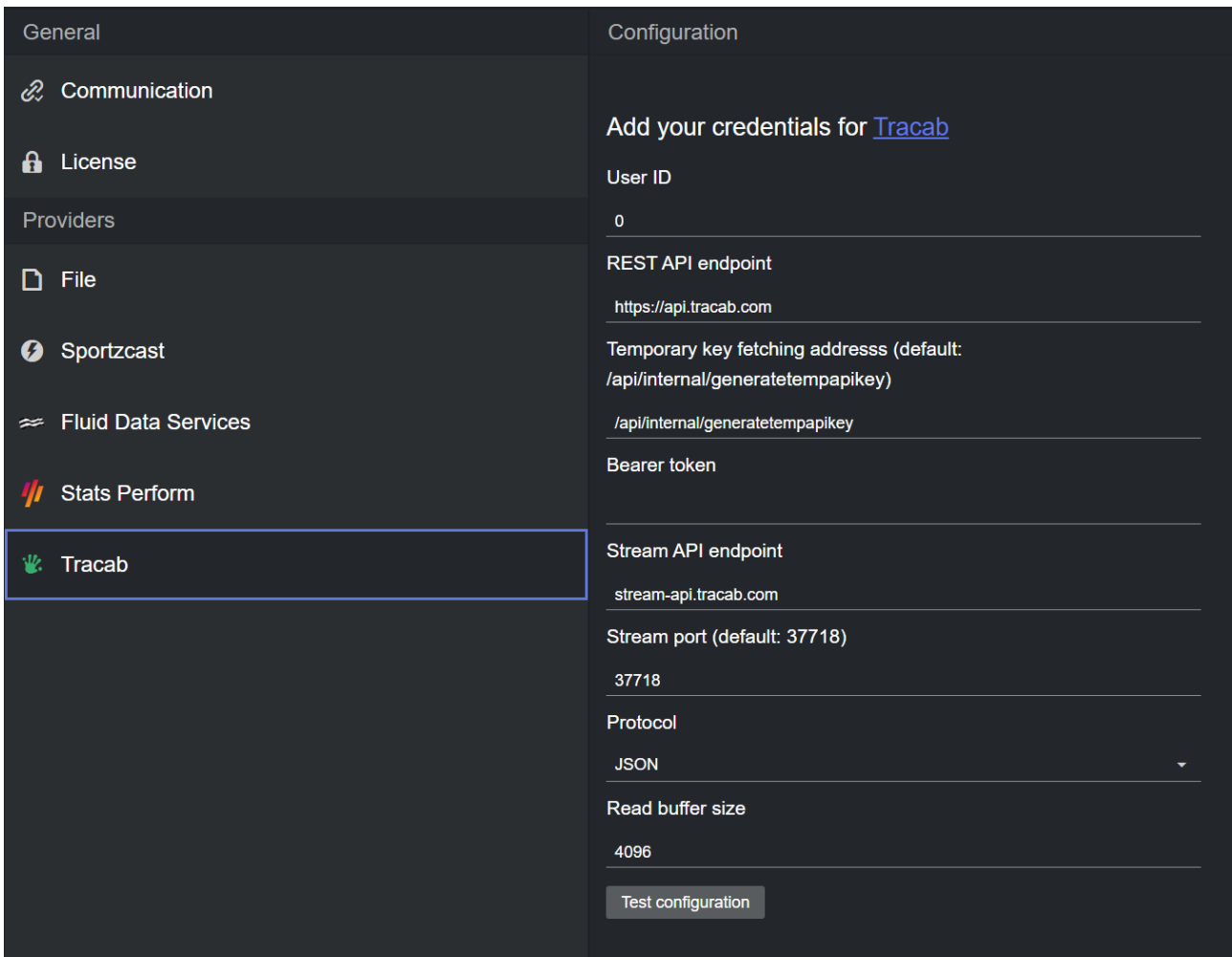

- **User ID:** User ID provided by Tracab.
- **REST API endpoint:** URL used to fetch metadata for a game.
- **Temporary key fetching address:** URL to fetch the authentication keys.
- **Bearer token:** Authentication bearer token provided by Tracab.
- **Stream API endpoint:** URL used to authenticate and request data streaming for a game.
- **Stream port:** Used to receive data.
- **Protocol:** Defines the received data format (JSON, ASCII or Binary).
- **Read buffer size:** Size of the buffer used to read data in.
- **Test configuration:** Used to test whether the specified configuration is correct. If correct, the button turns green, otherwise it turns red. Hovering over the button reveals the error in a tooltip:

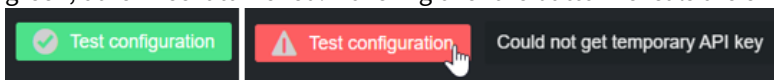

**Note:** Unless instructed otherwise, we recommend to leave the following options to their default value:

- **REST API Endpoint**
- **Temporary key fetching address**
- **Stream API endpoint**

- **Stream port**
- **Protocol**
- **Read buffer size**

## Sportec Solutions

Datacenter can be configured to fetch data from the [Sportec Solutions](#) data provider. For this integration to work, the following configurations must be performed:

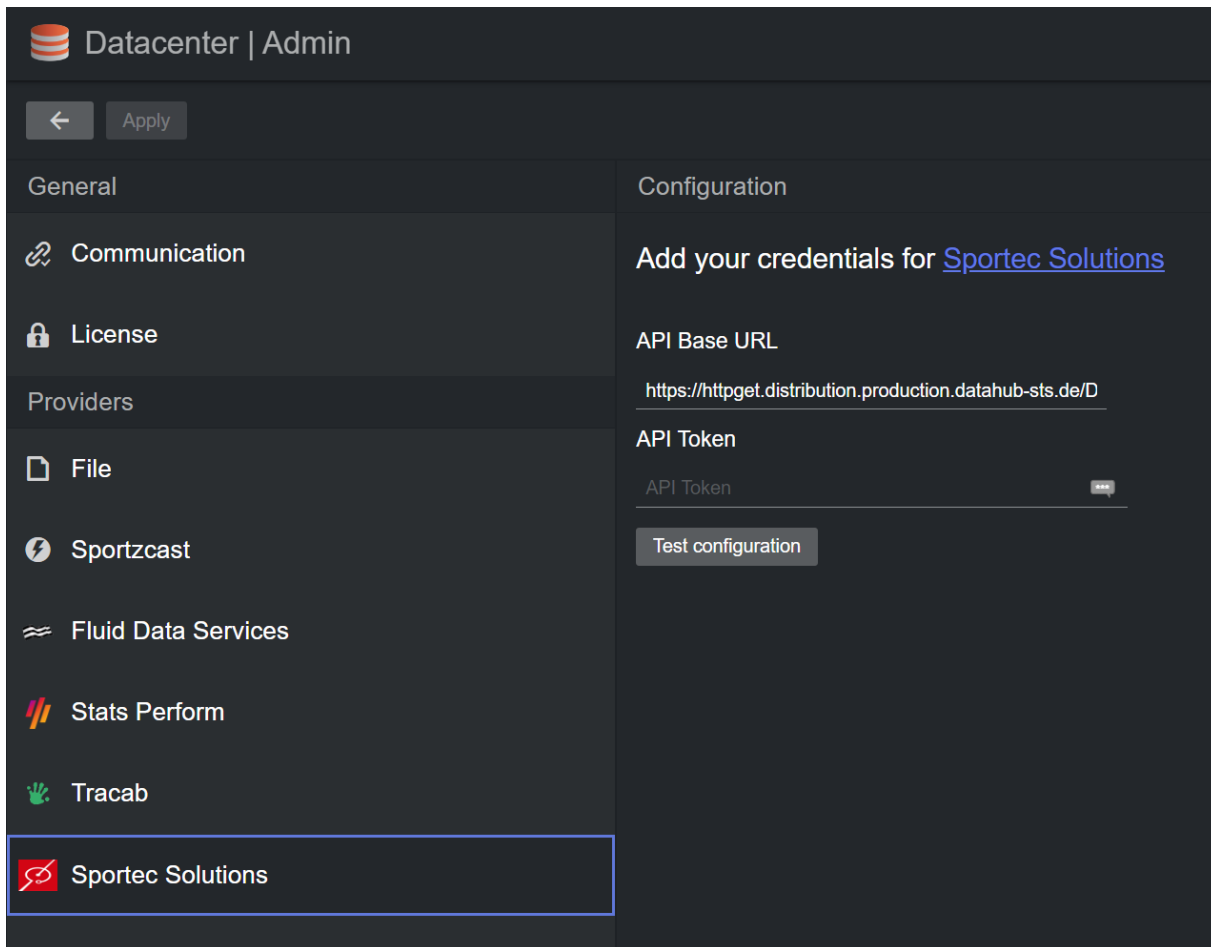

- **API Base Url:** The URL used to fetch data from the desired endpoints (default: <https://httpget.distribution.production.datahub-sts.de/DeliveryPlatform/REST/>).
- **API Token:** This input field is to specify the API token required to authenticate with the Sportec Solutions backend. The token must be obtained directly from the provider. When saved, the token is encrypted and its encrypted value is shown rather than the plain value (it is used when issuing HTTP(s) requests to the webserver).
- **Test configuration:** Use this button to test whether the specified configuration is correct. If correct, the button turns green, otherwise it turns red. Hovering over the button reveals the error in a tooltip:

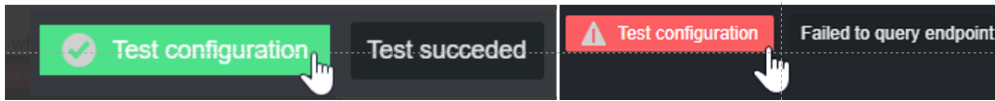

## 4.1.2 General Configuration

The General configuration page is where you can configure settings related to the Datacenter service:

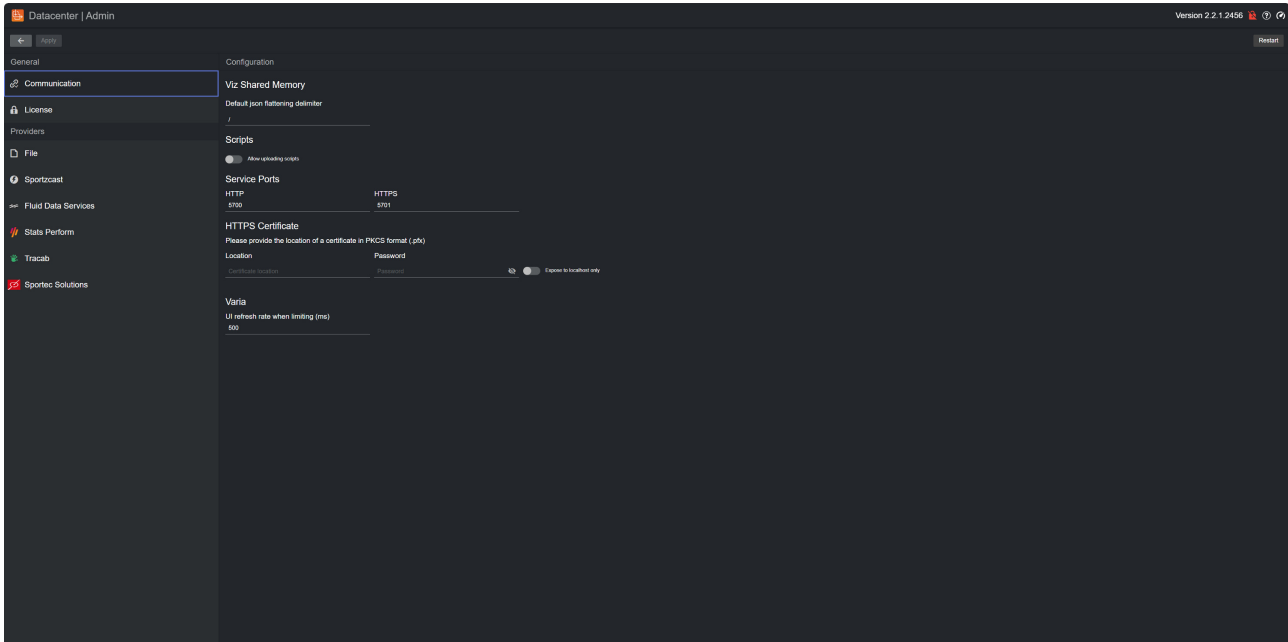

- [Communication](#)
  - [Viz Shared Memory](#)
  - [Script](#)
  - [Service Ports](#)
  - [HTTPS Certificate](#)
  - [Varia](#)
- [License](#)

### Communication

Under communication you can configure the shared memory and your HTTPS certificate.

The screenshot shows the 'Configuration' page with the following sections:

- Viz Shared Memory**: 'Default json flattening delimiter' is set to a backslash character (\).
- Script**: A toggle switch for 'Allow uploading scripts' is currently turned off.
- Service Ports**: A table with two columns: 'HTTP' (5700) and 'HTTPS' (5701).
- HTTPS Certificate**: A section with a prompt 'Please provide the location of a certificate in PKCS format (.pfx)'. It includes input fields for 'Location' (containing 'Certificate location') and 'Password' (containing 'Password'). There are also icons for file selection and a toggle for 'Expose to localhost only' which is turned off.

## Viz Shared Memory

The **json flattening delimiter** specifies the delimiter to use when [flattening an incoming JSON payload](#). The default value is |.

**Note:** The character | cannot be used in SHM keys used on Viz Engine with control channels. When control channels are used, nested channels in your scene can be accessed via the . character. Therefore, it can be used as a delimiter to map to control channels in the scene.

## Script

Use the **Allow uploading scripts** toggle to enable or disable script uploading in the main page. Uploading a script can be useful when you have no access to the machine where Datacenter runs.

**Script Uploading:** Datacenter does not vet uploaded scripts, therefore, allowing the upload of arbitrary scripts to Datacenter can pose a security threat. We **strongly recommend** to enable scripts uploading, only when strictly necessary and for the time required.

## Service Ports

By default, Datacenter uses ports 5700 and 5701 for HTTP and HTTPS communication, respectively. Should any of these ports be unavailable for the system, they can be changed in the dedicated text input field.

After clicking the **Apply** button, a dialog prompts you to confirm whether you want to restart the service using the newly configured ports. Please note the new addresses.



### Restart required

Some of your changes require a restart of the Datacenter.

After rebooting, if configured the HTTPS service will be available at <https://127.0.0.1:5701>.

Invalid changes to the HTTPS certificate settings will downgrade the Datacenter to HTTP, making it available at <http://127.0.0.1:6700>.

In case you have changed any service ports, please ensure that the correct firewall rules are applied for the new ports.

Restart now?



No

Yes

**Firewall Exceptions:** By default, the Datacenter installer, installs firewall rules for ports 5700 and 5701. When changing the service ports, you must ensure that correct firewall rules are applied for them, otherwise Datacenter may be unreachable.

## HTTPS Certificate

Datacenter runs an HTTP service that is reachable by localhost only on port `5700`, by default. This lowers security risks, and makes sure that unprotected communication is not exposed outside of the service machine.

When running as an HTTP service, a red, broken lock is shown in the top-right corner of the UI   . Although HTTP is the default service, Datacenter is capable of running an HTTPS secure service, which handles communication using the HTTPS protocol on port `5701`. To do so, input the location of your signed certificate and its password in the dedicated text input fields, and click on **Apply changes**.

A dialog prompts you to confirm whether you want to restart the service, as it is required to upgrade to HTTPS.

### Restart required

Some of your changes require a restart of the Datacenter.

After rebooting, if configured the HTTPS service will be available at <https://127.0.0.1:5701>.

Invalid changes to the HTTPS certificate settings will downgrade the Datacenter to HTTP, making it available at <http://127.0.0.1:5700>.

In case you have changed any service ports, please ensure that the correct firewall rules are applied for the new ports.

Restart now?



No

Yes

By default, the HTTPS service listens to all network interfaces on port `5701`, as this allows communication in and out of the Datacenter service machine. However, also the HTTPS service can be limited to listen to the localhost only.

Use the **Expose to localhost only** toggle and apply changes if required.

When running Datacenter as an HTTPS service, a green, closed lock is shown in the top-right corner of the UI

Version 2.0.0  

**Note:** To setup Datacenter to run an HTTPS service, a signed certificate in PKCS format must be provided (this can usually be obtained by your system admin). Please note that the Datacenter does not provide signed certificates. Should you not already have a certificate-authority provided certificate, there exist several services that can issue signed certificates (for example, [letsencrypt.org](https://letsencrypt.org)).

**Note:** When running Datacenter as an HTTPS service, an HTTP version of the service is also started on localhost on port 5700. As in the standard HTTP version of Datacenter, this service listens to localhost only.

### Create Self-Signed Certificates

In case you are not able to obtain a certificate-authority provided certificate, a self-signed certificate can be used to run the Datacenter as a HTTPS service. This, however, is not the recommended nor preferred way to setup the Datacenter in HTTPS mode, and should be only done under the supervision of your IT team and following an informed decision to use self-signed certificates. While self-signed certificates are easy to obtain, they do not provide any trust value, and are rejected by many communicating actors, including some data providers. Nevertheless, should a self-signed certificate be required, the following steps can be followed.

**Info:** [OpenSSL](#) can be used to create a self-signed certificate. While OpenSSL is already installed on many major Linux distributions, on Windows workstations one may use the one shipped with [Git](#), or install it from known package managers (for example, [chocolatey](#)).

On your workstation, open a Terminal and then follow the steps below:

1. Create a private key.

```
$ openssl genrsa -des3 -out domain.key 2048
```

**Info:** Make a note of the "PEM pass phrase", as this is used later in this guide.

2. Create a certificate sign request (CSR).

```
$ openssl req -key domain.key -new -out domain.csr
```

Enter pass phrase **for** domain.key:

You are about to be asked to enter information that will be incorporated into your certificate request.

What you are about to enter is what is called a Distinguished Name or a DN.

There are quite a few fields but you can leave some blank

For some fields there will be a default value,

If you enter '.', the field will be left blank.

-----

Country Name (2 letter code) [AU]:XX

State or Province Name (full name) [Some-State]:YY

```

Locality Name (eg, city) []:YYyy
Organization Name (eg, company) [Internet Widgits Pty Ltd]:MY_ORG
Organizational Unit Name (eg, section) []:MY_UNIT
Common Name (e.g. server FQDN or YOUR name) []:MY_DATACENTER_HOST_NAME
Email Address []:

```

Please enter the following 'extra' attributes to be sent with your certificate request

A challenge password []:

An optional company name []:

3. Create a self-signed certificate. /info

```
openssl x509 -signkey domain.key -in domain.csr -req -days 365 -out domain.crt
```

**Info:** If you are required to issue the "Common Name", you can use the same `MY_DATACENTER_HOST_NAME` as used above.

4. Create a Self-Signed Root CA.

```
$ openssl req -x509 -sha256 -days 1825 -newkey rsa:2048 -keyout rootCA.key -out rootCA.crt
```

**Info:** Make note of the PEM pass phrase, as this is used in the next step when signing certificates requests.

Common Name for CA

**Info:** Use a different "Common Name" than the one used previously, for example `ROOT_HOST_NAME`.

5. Sign the CSR with the Root CA.

```
$ openssl x509 -req -CA rootCA.crt -CAkey rootCA.key -in domain.csr -out domain.crt -days 365 -CAcreateserial
```

6. Convert the PEM to PKCS12 (as needed by Datacenter).

```
$ openssl pkcs12 -inkey domain.key -in domain.crt -export -out domain.pfx
```

**Info:** Make a note of the password used as "Export Password", this is required in the [Datacenter Settings](#) page.

7. Copy the pfx file to the machine running Datacenter if required and use it to [launch the Datacenter in HTTPS mode](#).

## Varia

Set the **UI refresh rate when limiting (ms)** to the desired milliseconds to control the slowing-down factor of the UI refresh rate when running in limited refresh rate mode (the Application Bar shows the speedometer icon in yellow ).

## License

In this section you can configure the license to use with Datacenter, as well as the licensed providers. Without a valid Datacenter Core V3 license, no outputs can be configured, nor datasets created, thus no data is streamed out of Datacenter. Additionally, certain providers require specific addons license.

Datacenter requires a WIBU based software license. The CodeMeter license service checks for available licenses and presents the relevant license containers in a dropdown menu next to the License label.

When selecting a license from the list, its information is shown on the right. Additionally, the available (and not expired) Providers license addons on the container, are listed as toggles.

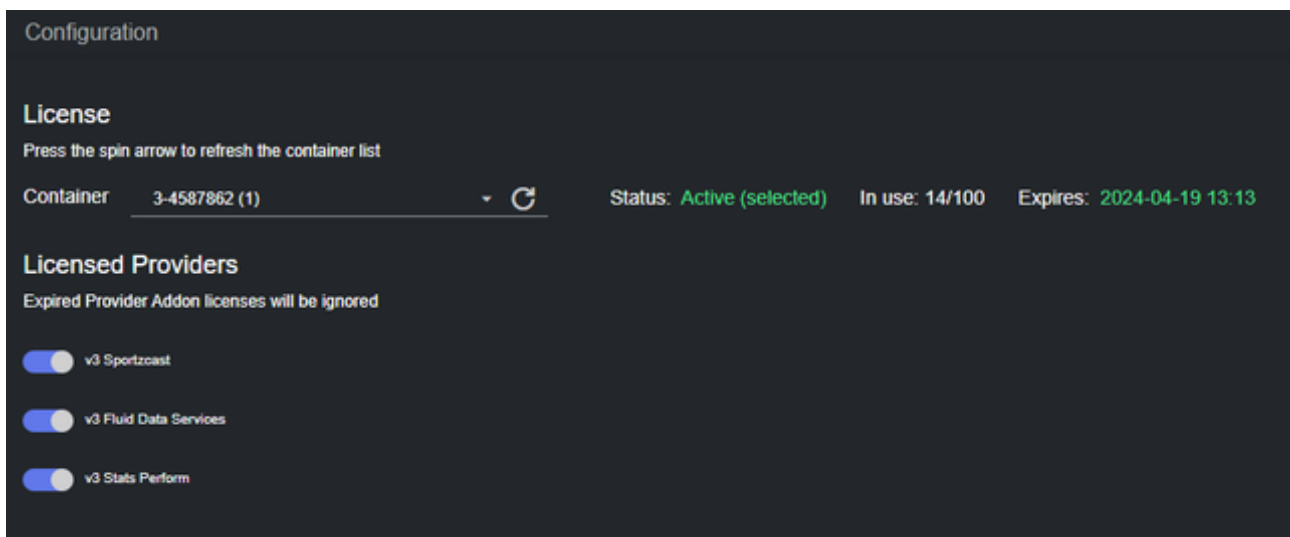

If you do not see the container you wish to use, click the refresh button  to trigger a new scan of available licenses.

The currently selected container is listed as **Active (selected)** in the information line. The available containers and expiration date are also shown in the same line. If the license is not expired, its expiration date is shown in green:

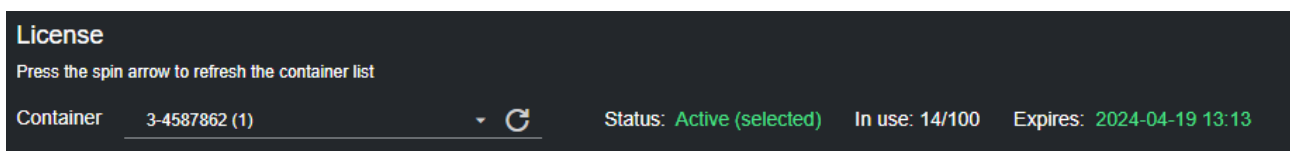

Conversely, expired licenses list their expiration date in red. Similarly, licenses that are not selected, are listed as **Inactive (not selected)**.

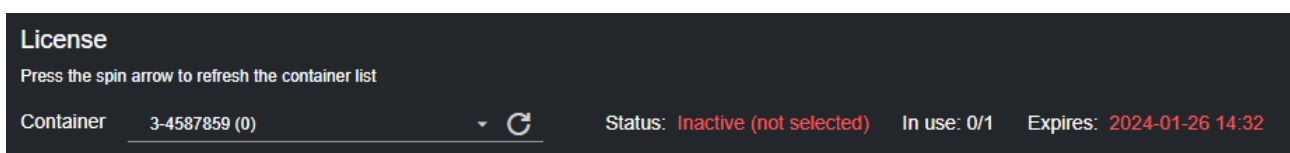

After choosing a container, please allow the software to fetch the licensed providers addons, and then select the ones you want to use from the list of toggle buttons that appears next to the **Licensed Providers** label. When done, click on **Apply changes**.

---

## 4.2 Configuring Outputs

To correctly send data to various Outputs from the Datacenter, the receiving end(s) need to be configured correctly.

This section describes how to configure all of the Outputs in Datacenter, including:

- [Viz Engine Configuration](#)
- [Viz Libero Configuration](#)
- [Viz Arena Configuration](#)
- [Viz Arc Configuration](#)

## 4.2.1 Viz Engine Configuration

Each Viz Engine receives live data from Datcenter, and it must be configured to listen to the **Shared Memory** input over the [configured communication protocol](#). This should also be done for any preview Viz Engine that may be in use.

To configure a Viz Engine to receive incoming data from Datcenter, please follow these steps:

1. Open the Viz Engine configuration.
2. Got to **Communication > Global**.
  - a. Make sure the **General Communication Port** is set to a port available in your system.

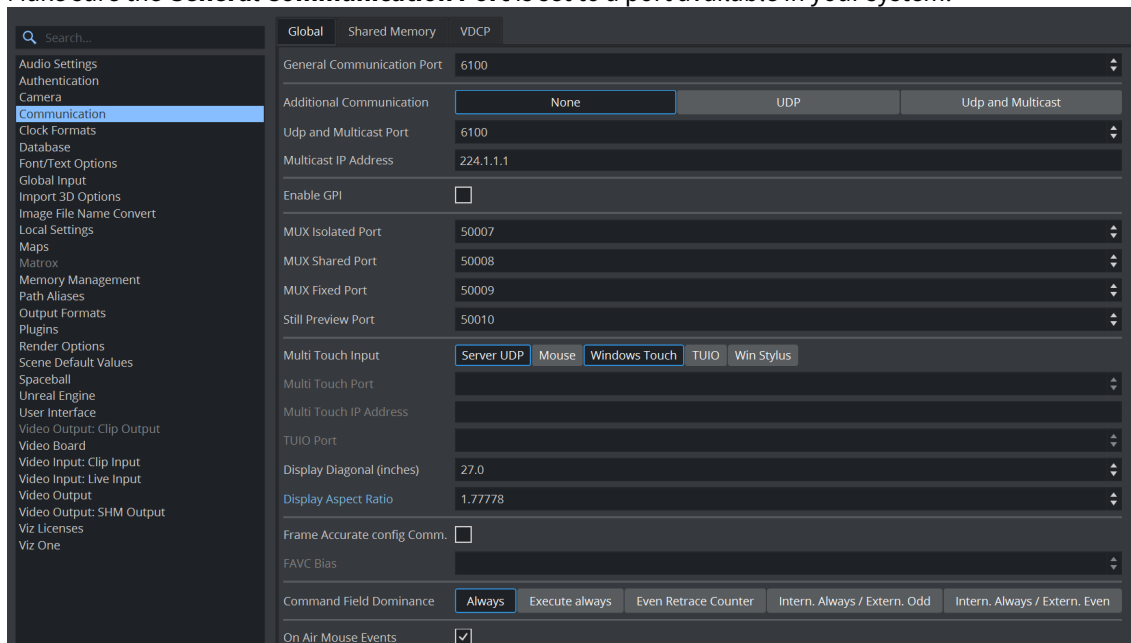

3. Go to **Communication > Shared Memory**.
  - a. Depending on the [communication protocol chosen for the Viz Engine outputs](#) in Datcenter, enter either a UDP or a TCP port number (or both if a AUTO-selecting protocol output is used).

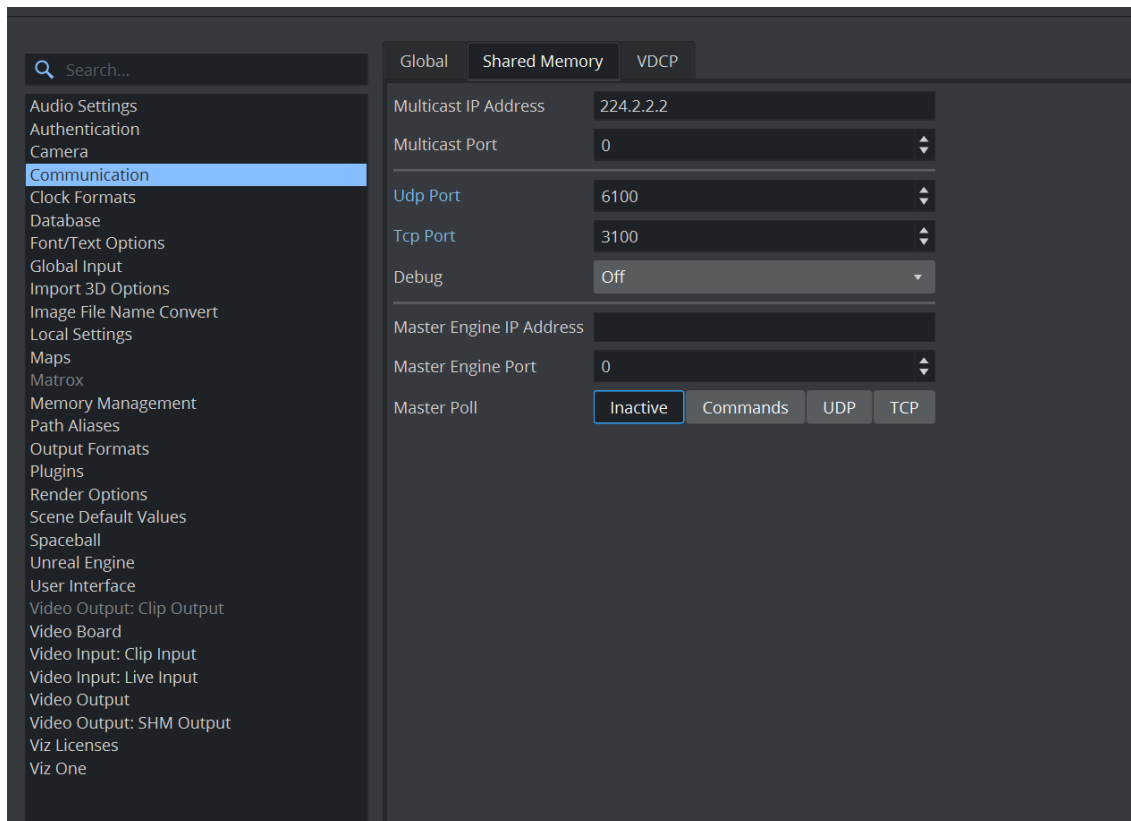

4. Save the configuration and restart.

**Note:** Take note of the **General Communication Port** specified in the Viz Engine configuration panel, as this is required when [configuring the relevant port for the output](#) in Datacenter.

Your Viz Engine is now ready for the Datacenter live input.

## Monitor the Incoming Data on a Viz Engine

To monitor the incoming data on a Viz Engine Shared Memory channel, a REST webservice can be installed from the Viz Engine Settings. To do so:

- Open the Viz Engine Configuration, navigate to **Communication > Global**.
- Locate the **REST Webservice** field and enter a port number available on your system.
- Click **Install** and close the settings.

You should be able to monitor the various Shared Memory channels in the address **http://localhost:<YOUR\_PORT>#/sharedmemory**.



Viz Engine Status Shared Memory Documentation

# Shared Memory

Refresh

System VizCommunication Scene

System Map

Key	Value	
SHMCLIP0	0	delete
SHMCLIP0Mode	0	delete
SHMCLIP1	0	delete
SHMCLIP10	0	delete
SHMCLIP10Mode	0	delete
SHMCLIP11	0	delete
SHMCLIP11Mode	0	delete
SHMCLIP12	0	delete
SHMCLIP12Mode	0	delete
SHMCLIP13	0	delete
SHMCLIP13Mode	0	delete
SHMCLIP14	0	delete
SHMCLIP14Mode	0	delete

Key:

Value:

Add

## 4.2.2 Viz Libero Configuration

The outputs required to integrate with Viz Libero are created by Viz Libero upon connection.

Please check the *Viz Libero User Guide* for relevant configuration options.

### 4.2.3 Viz Arena Configuration

Viz Arena requires a Datacenter output configuration, for each of its configured Viz Engines (both preview and programs(s)).

Please check the *Viz Arena User Guide* to learn where to retrieve the relevant configuration options.

## 4.2.4 Viz Arc Configuration

Each Viz Arc configured as an output in Datacenter, receives live data from it. As data is posted to Viz Arc using an HTTP POST protocol, a valid port must be specified for the **Arc Web Server Port** field found in **Setting > General > Communication** of the Viz Arc Configuration panel:



Communication	
{ } REST Port	9004
☐ Arc TCP Server Port	9204
📶 MQTT Broker Port	1883
☐ Arc Web Server Port	5004
📄 Whitelist IP Range	0.0.0.0/0

*Rest service restart required for change to take effect*

When changing the Web server port, restart Viz Arc to make sure the new changes are applied.

Your Viz Arc is now configured to received data from Datacenter.

**Note:** Take note of the port specified in the Viz Arc configuration panel, as this is required when [configuring the relevant port for the output](#) in Datacenter.

---

## 5 Operating Datacenter

This section provides information on how to operate correctly the Datacenter system:

- [Getting Started](#)
- [Accessing Datacenter](#)
- [Creating Datasets](#)
- [Configuring Datasets](#)
- [Outputs](#)

---

## 5.1 Getting Started

To add live data to your graphics with Datacenter, follow these simple steps:

1. [Configure your output\(s\)](#) application to be ready to receive incoming data. Make sure to configure or load a correct [Viz Engine scene](#) that works with Datacenter.
2. [Access](#) the Datacenter main UI and [configure](#) it to add information, such as provider APIs or folders to monitor.
3. [Create one or more datasets](#) and [configure them](#).
  - a. Each data set contains a list of key/value-pairs that you can [filter](#), [edit](#) and [control](#) in real-time, deciding which values should be sent to your output(s) to populate their graphics.
4. [Create and configure one or more Outputs](#) to receive live data.

**Note:** Viz Libero and Viz Arena configure the necessary datasets upon installation, and Viz Libero also creates the necessary output when connecting. Therefore, only the relevant provider access tokens need to be configured for a successful Viz Libero integration. However, for a successful Viz Arena integration, the desired output(s) need to be configured.

---

## 5.2 Accessing Datacenter

### 5.2.1 Accessing Datacenter

The Datacenter runs automatically as a service on the host machine. It automatically starts on Windows startup, and its status can be monitored in **Task Manager > Services > VizrtDataCenter**.

While the service is always running in the background, the main user interface can be opened by navigating, using a browser on the same machine hosting the service, to one of the following addresses:

- <http://127.0.0.1:5700>. This address is always available, regardless of the service mode configured (see [HTTPS Certificate](#) configuration).
- <https://127.0.0.1:5701>. This address is only available if a valid HTTPS certificate has been configured (see [HTTPS Certificate](#) configuration).

If Datacenter is correctly configured to run an HTTPS backend that listens to all network interfaces, then the user interface is also reachable from:

- <https://<host-machine-ip>:5701>, where *<host-machine-ip>* is the public facing IP of the host machine. This mode allows you to reach and monitor Datacenter from all of the machines in the same network.

**Info:** The Admin page is only accessible when the Datacenter user interface is reached using the localhost address option.

## 5.3 Creating Datasets

The Datasets panel list, shows all the existing datasets and allows you to create new ones. Existing datasets can be filtered or searched using the respective elements at the top of the list.

The following section explains how to interact with datasets in Datacenter, including:

- [Creating a Dataset](#)
- [Tagging a Dataset](#)
- [Duplicate an Existing Dataset](#)
- [Disabling or Deleting a Dataset](#)
- [Monitoring a Dataset State](#)

### 5.3.1 Creating a Dataset

To create a new dataset, use the Dataset pane and press the **+** button to start.

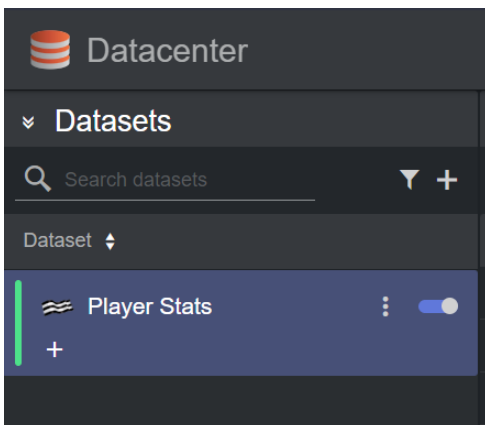

A new panel is shown where you can fill the necessary information.

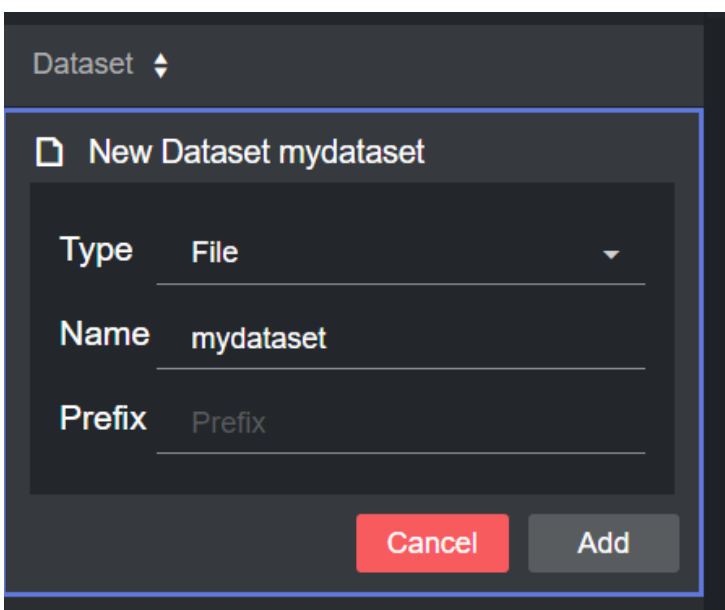



- **Type:** Choose the Provider type for this dataset.
- **Name:** Type a (unique) name for this dataset.
- **Prefix:** This field can be used if keys from different datasets are equal and you need to make them unique. This option is particularly useful when two datasets contain the same key (for example player stats for different players) and should be used simultaneously for the same output. Without using a prefix for one (or both) of the datasets, the values in the scene associated to the duplicate keys would be randomly taken from one of the datasets.

Click the **Add** button to create the dataset, or **Cancel** to abort.

Please refer to the [Providers](#) page for specific providers information on how to create a dataset.

### 5.3.2 Tagging a Dataset

In order to access individual datasets via the [simple page](#), tags can be given to a dataset. To do so, use the "+" icon on the dataset:

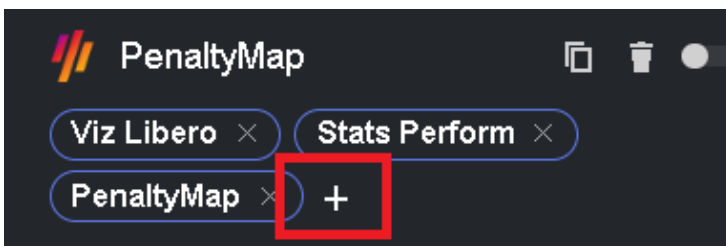

### 5.3.3 Duplicate an Existing Dataset

Instead of creating each dataset from scratch, you can duplicate existing datasets, and subsequently change some of their properties (for example, change a prefix or add a new endpoint to pull data from). To do so, locate the dataset to clone, expand the hamburger menu next to the name and click on the Duplicate icon .

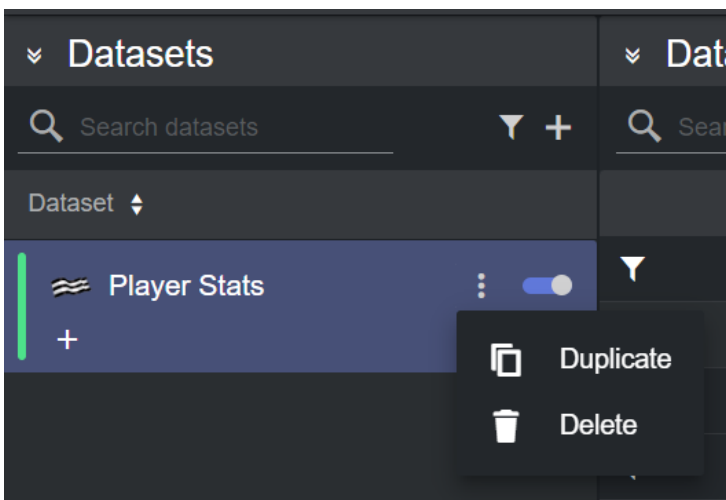

A new dataset is created with the default name *Copy of <original dataset name>*.

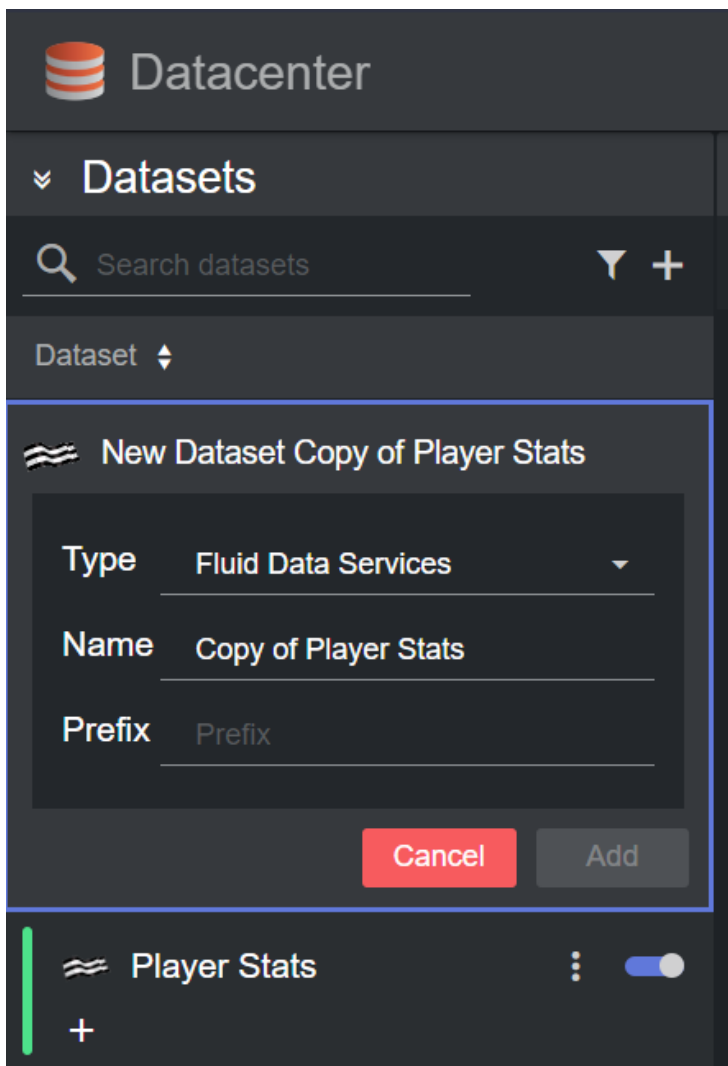

**Info:** When cloning a dataset, all the properties of the original datasets including data sources and specific settings, are assigned to the new datasets.

### 5.3.4 Disabling or Deleting a Dataset

A dataset can be permanently deleted or temporarily disabled. These are the steps for each:

- To delete a dataset, expand the hamburger menu next to its name and click on the Delete icon. The dataset is removed, and all its data is removed immediately from the outputs.

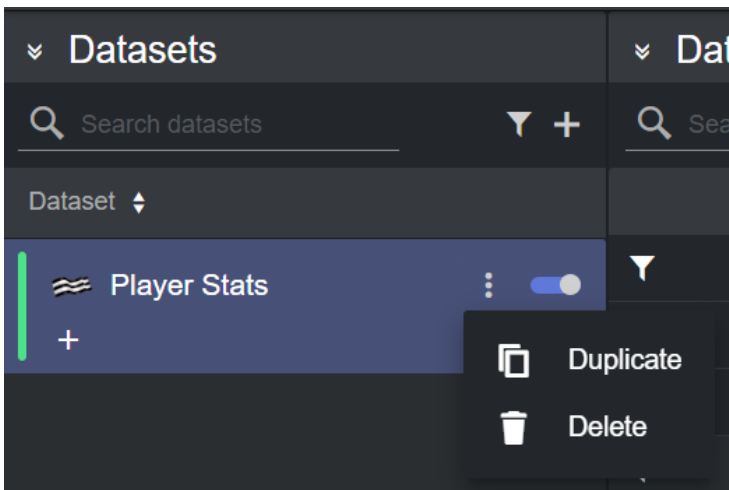

**Note:** This operation is destructive, as the dataset cannot be recovered after deleting it.

- To disable a dataset, click on the toggle next to its name:
  - A blue toggle means that the dataset is currently active.
  - A grey toggle means that the dataset is currently inactive.

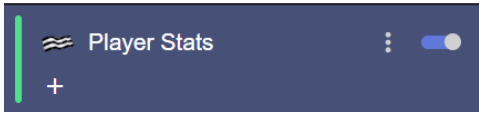
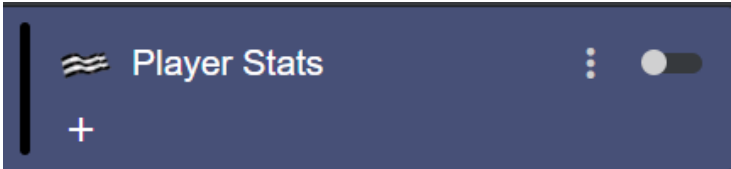
Status	
Active	
Inactive	

### 5.3.5 Monitoring a Dataset State

A dataset can be in three distinct states:

- **OK:** The dataset is correctly configured and has data entries.
- **Warning:** The dataset is not correctly configured and has (potentially) no data entries.
- **Error:** The dataset source or the dataset itself has blocking errors which prevents the dataset from working correctly.

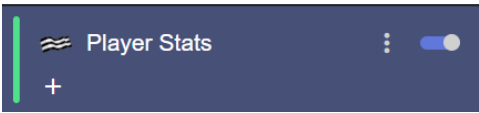
Status	
OK	

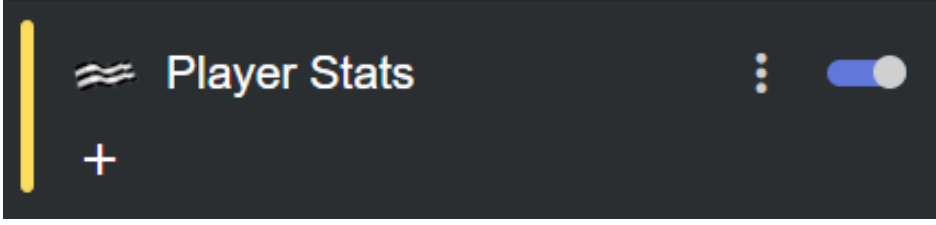
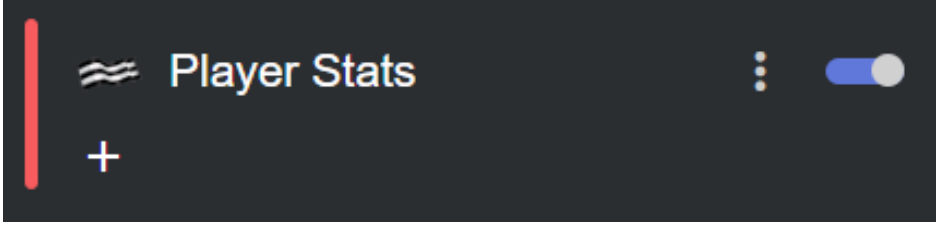
Status	
WARNING	
ERROR	

When one or more datasets are in warning or error state, the app bar shows a red or yellow icon in the top-right corner.

To obtain more information on a dataset in either Warning or Error state, hover the mouse on the dataset name to reveal a tooltip with further information and potential fixes.

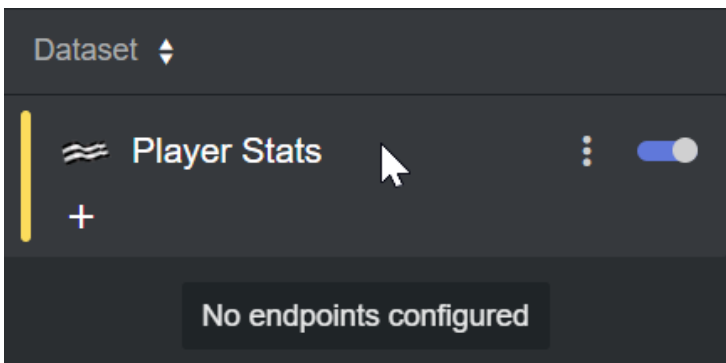

Once all datasets are in the OK state, the app bar shows a green icon .

## 5.4 Configuring Datasets

The Datacenter allows communication with a variety of Providers, supporting a variety of technologies used to retrieve data.

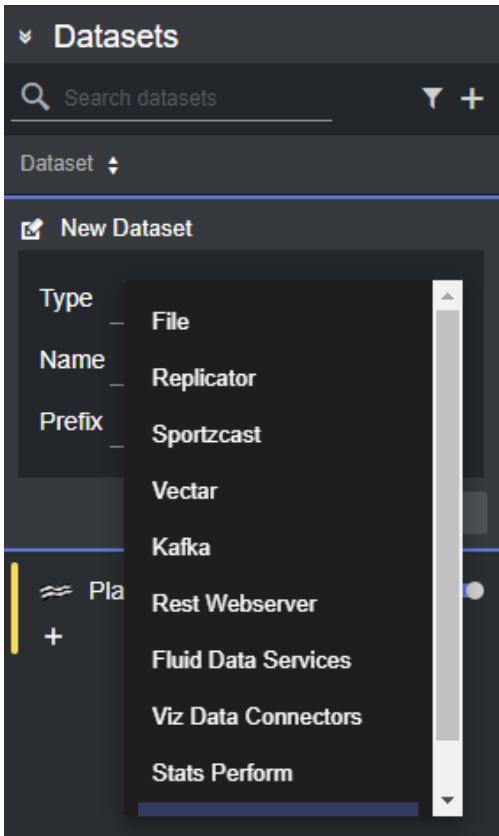

The following Providers can be used to acquire live data from:

- **Manual:** You can specify the key/value pairs manually.
- **File:** Reads and monitors data from the configured files.
- **Replicator:** Replicates data from a specific dataset from a Datacenter instance that runs on a different machine.
- **Sportzcast:** Provides live data from electronic scoreboards in stadiums, as offered by [Sportzcast by Genius Sports](#).
- **Vectar:** Accesses the DataLink data source configured in Viz Vectar.
- **Kafka:** Provides data from a configured [Apache Kafka](#) broker.
- **Rest Webserver:** Fetches data from a generic REST-based webserver.
- **Fluid Data Services:** Provides live and telemetry as offered by the [Fluid Data Services](#) data provider.
- **Stats Perform:** Provides live and statistical data as offered by the [Stats Perform](#) data provider.
- **Viz Data Connectors:** Provides data from a configured [Viz Flowics](#) existing account. This mode requires a valid Flowics Middleware to be correctly configured and running.
- **Socket Listener:** Listens for incoming data via a UDP or TCP socket.
- **Socket Connector:** Connects to a TCP server and initiate data streaming (incoming) via TCP.

- [Tracab](#): Provides live and statistical data as offered by the [Tracab](#) data provider.

Depending on the Provider chosen, the configuration of each Dataset differs.

The rest of this section illustrates how to configure datasets for each of the supported providers:

- [Supported Providers](#)
- [Filtering and Manipulating a Dataset Entries](#)
- [Enabling or Disabling Dataset Entries](#)
- [Inspecting Dataset Entries](#)
- [Working with Live Data: the Performance Dashboard](#)
- [Joining Endpoints Parameters](#)

## 5.4.1 Supported Providers

This section provides information on how to configure the supported datasets:

- [Sportec Solutions](#)
- [Stats Perform](#)
- [Fluid Data Services Dataset](#)
- [Rest Webserver Dataset](#)
- [Viz Data Connectors](#)
- [Manual Dataset](#)
- [File Dataset](#)
- [Replicator Dataset](#)
- [Sportzcast Dataset](#)
- [Tricaster Vectar](#)
- [Kafka Dataset](#)
- [Socket Listener](#)
- [Socket Connector](#)
- [Tracab](#)

## Sportec Solutions

These are the steps to configure a [Sportec Solutions](#) dataset.

1. Create a new dataset of type **Sportec Solutions**, specifying a name and (optionally) a prefix to use to identify the dataset and its values, respectively:

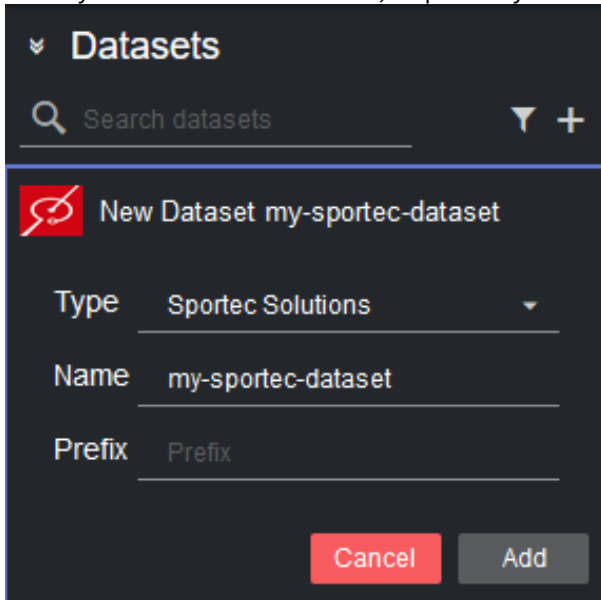

2. Click **Add**. The dataset is added to the list, and it has an initial WARNING status as it contains no configured endpoints yet.



3. Select one or more endpoints from the table in the **Dataset configuration** panel by double clicking a row. A new endpoint card is then created.





Name	Description
Competition	The competition
Season	The season of a specific competition
Club	The clubs of a specific season
Matchday	Matchdays of a specific competition
Match	The matches scheduled in a specific matchday
MatchInformation	Information about a specific match
AttackingZones	Attacking zones data of a specific match
MatchEvents	Raw events of a match
HeatMap	HeatMap of player positions for a specific match
ClubStatisticsMatch	Statistics of a specific club and its players within a season, and up to a specific matchday
PenaltiesGoalmouth	The last ten penalties of players in a specific competition

 **HeatMap**

HeatMap of player positions for a specific m...

Alternatively, you can enter a new endpoint by clicking **Add new endpoint** on the right-side of the panel, and then clicking on the empty endpoint that is added at the bottom of the table to configure it.

 **Dataset configuration**

 Add new endpoint

Doing so reveals the new endpoint details in the Endpoint template parameters on the right side, where its properties can be entered./info

✕ **Endpoint template parameters**

Name

New Endpoint

---

Description

Description

---

Endpoint

DFL-04.06-Heatmaps-Match/{Match}

---

Dependency filter

---

✕ **Endpoint fixed options**

Name

---

**Endpoint Options:** When adding a new endpoint, parameters (for example, parts of the endpoint whose value should be fetched from other endpoints) should be encapsulated in curly braces: {part\_name}. The value inside curly braces is resolved either by using other endpoints present in the **Dataset configuration** table, or the ones specified in the **Endpoint fixed options** section of the right-most column in the main view.

Using as an example the images above, the following endpoint `/DFL-04.06-Heatmaps-Match/{Match}`, would use the {Match} options from the respective endpoint in the table.

- Once an endpoint is added to a dataset, you can select the endpoint card. This reveals the Endpoint parameters panel on the right side, where its properties can be entered. You can now edit the endpoint configuration (**Competition** and **Matchday**, as shown in the image below):

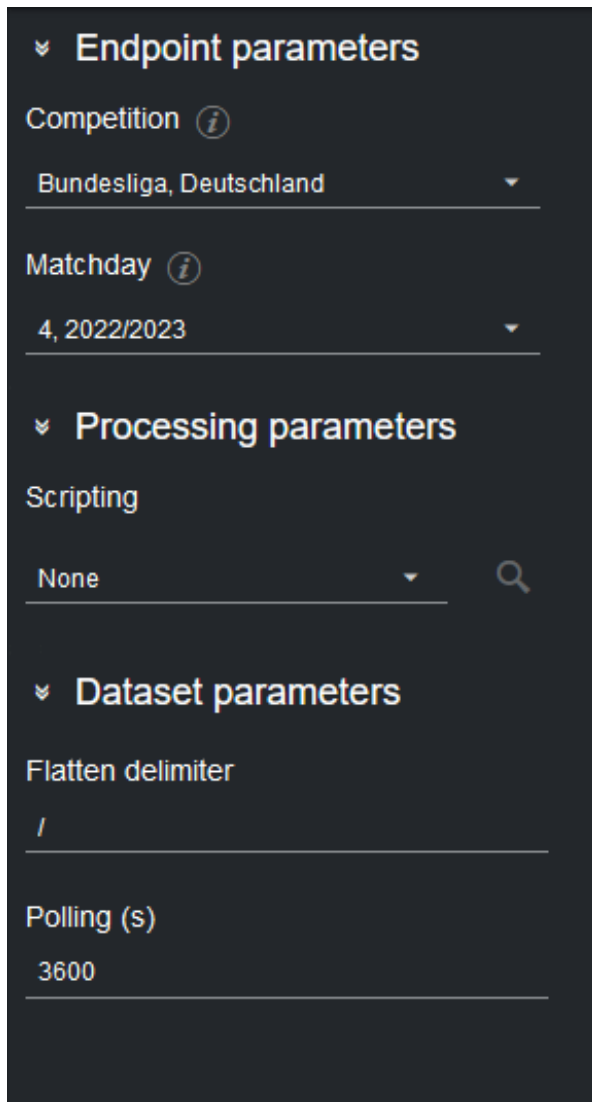

The screenshot shows a dark-themed configuration panel with the following sections:

- Endpoint parameters**
  - Competition ⓘ  
Bundesliga, Deutschland
  - Matchday ⓘ  
4, 2022/2023
- Processing parameters**
  - Scripting  
None
- Dataset parameters**
  - Flatten delimiter  
/
  - Polling (s)  
3600

5. To change the polling rate (how often the Sportec Solutions remote host is polled for data, in s) for the dataset, select a card from the list and edit the **Polling** field in the Dataset parameters on the right-most column.

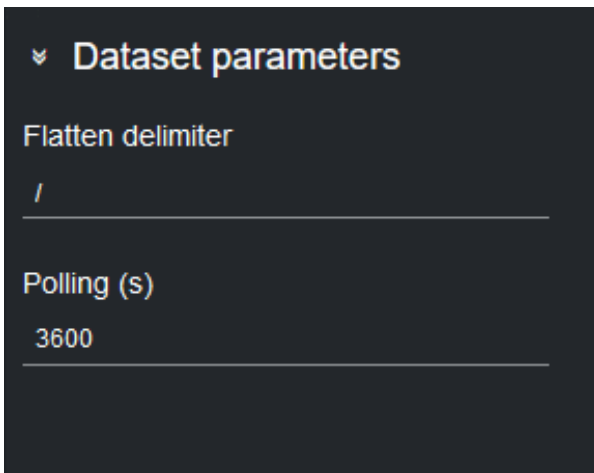

6. When done, the data is added to the **Dataset output** table.

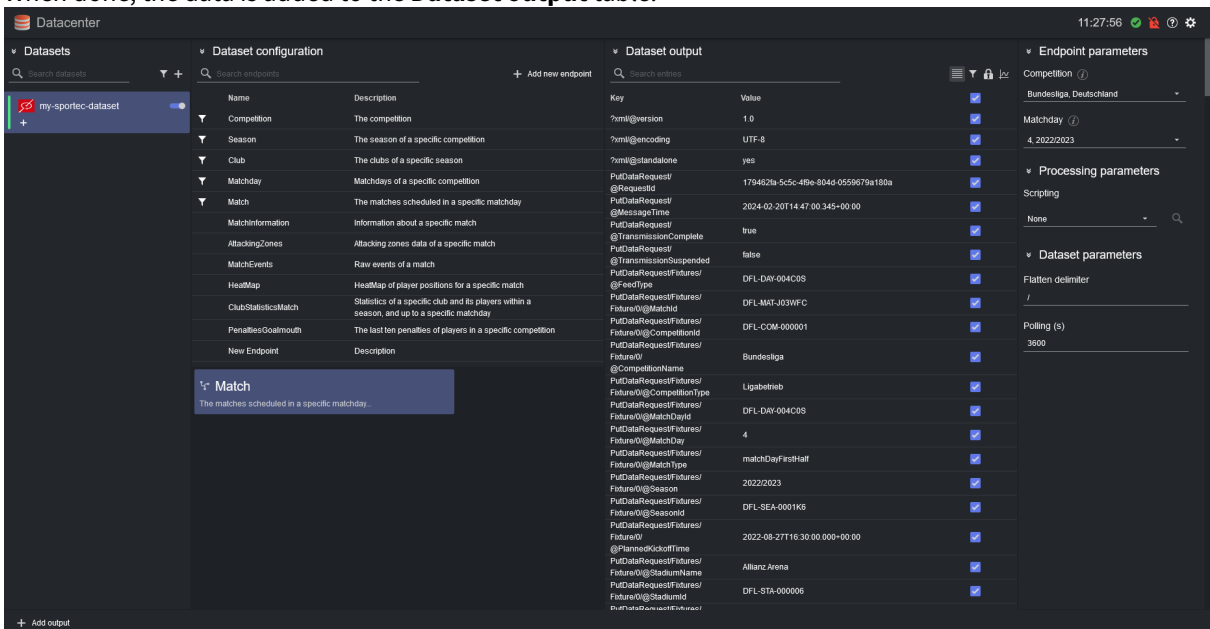

### Filtering a Dataset

Values read from a file into a dataset can be filtered via the Filtering tool. To do so, select the dataset card, click on the hamburger menu and then press the **Filter** button.

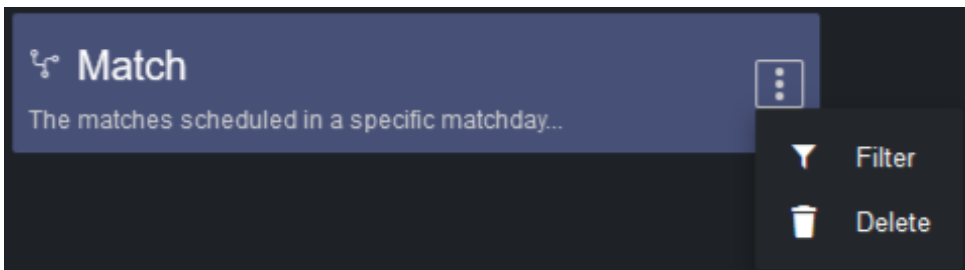

A dialog visualizing the file's payload schema opens, where you can filter the source data.

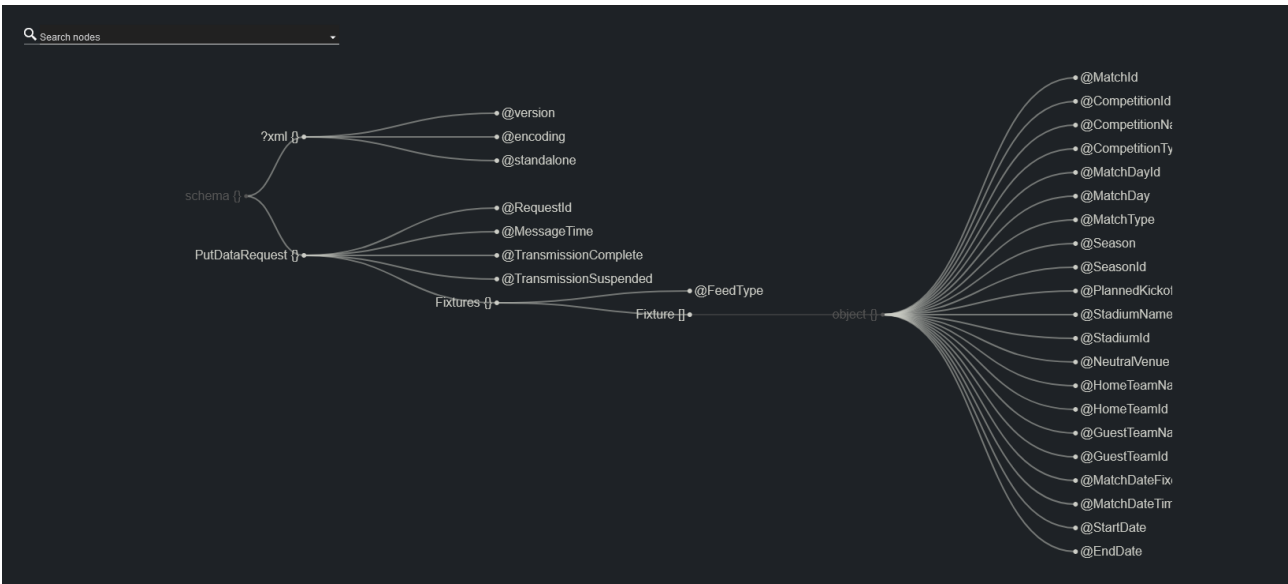

Please refer to the [Filtering and Manipulating a Dataset Entries](#) page to learn how to enable, disable and edit the entries added.

## Stats Perform

These are the steps to configure a **Stats Perform** dataset.

1. Create a new dataset of type **Stats Perform**, specifying a name and (optionally) a prefix to use to identify the dataset and its values, respectively:

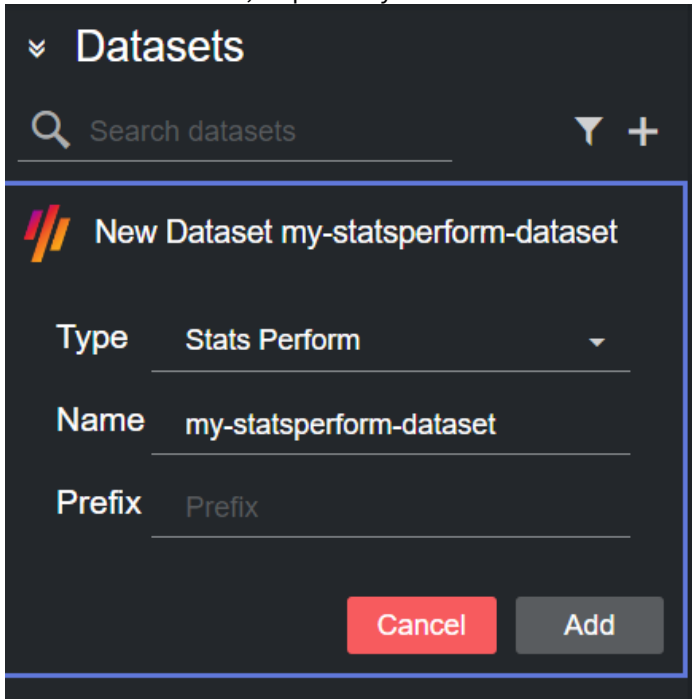

The screenshot shows a dark-themed 'Datasets' panel with a search bar and a '+', a dropdown arrow, and a search icon. Below is a 'New Dataset' modal window titled 'New Dataset my-statsperform-dataset'. It contains three input fields: 'Type' with a dropdown menu set to 'Stats Perform', 'Name' with the text 'my-statsperform-dataset', and 'Prefix' with the placeholder text 'Prefix'. At the bottom are two buttons: a red 'Cancel' button and a grey 'Add' button.

2. Click **Add**. The dataset is added to the list, and it has an initial WARNING status as it contains no configured endpoints yet.

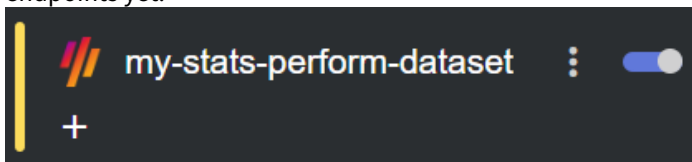

3. Select one or more endpoints from the table in the **Dataset configuration** panel by double clicking a row. A new endpoint card is then created.

▼	Competition	The league (Competition)	🗑️
▼	Season	The season of a specific competition	🗑️
▼	Match	The matches (Fixtures) of a specific season	🗑️
▼	Team	Teams of a specific match	🗑️
▼	Player	The players of a specific team of a specific match	🗑️
	MatchEvents	All match events of both teams	🗑️
	MatchEventsTeam	All match events of a specific team	🗑️
	MatchEventsTeamPlayer	All match events of a specific player	🗑️
	MatchStats	All statistics of a match	🗑️
	MatchPenaltiesPreview	All historical penalties relevant for a match	🗑️
	Id_10	Description	🗑️



## MatchEvents

All match events of both teams

Alternatively, you can enter a new endpoint by clicking **Add new endpoint** on the right-side of the panel, and then clicking on the empty endpoint that is added at the bottom of the table to configure it.

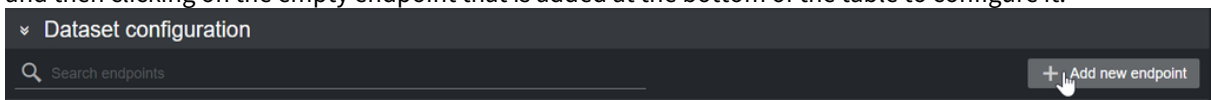

Doing so reveals the new endpoint details in the Endpoint template parameters on the right side, where its properties can be entered.

⌵ **Endpoint template parameters**

**Name**

Id\_26

---

**Description**

Description

---

**Endpoint**

---

**Dependency filter**

---

⌵ **Endpoint fixed options**

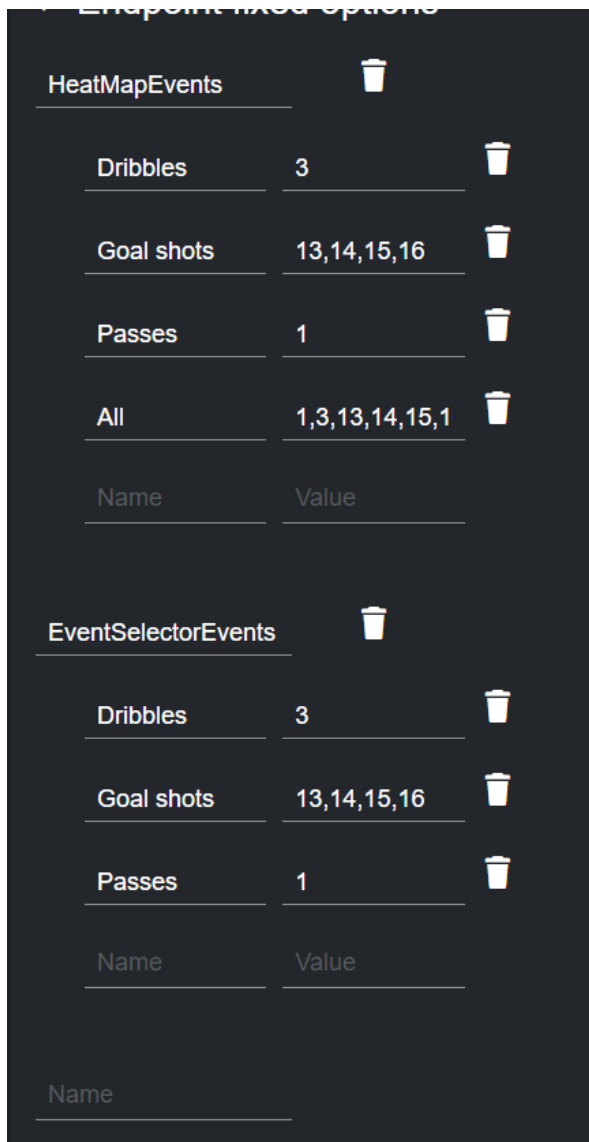

**Endpoint Options:** When adding a new endpoint, parameters (for example, parts of the endpoint whose value should be fetched from other endpoints) should be encapsulated in curly braces: {part\_name}. The value inside curly braces is resolved either by using other endpoints present in the **Dataset configuration** table, or the ones specified in the **Endpoint fixed options** section of the right-most column in the main view.

Using as an example the images above, the following endpoint `/soccerdata/matchevent/{outletAuthKey}/{Match}?ctst={Team}&type={EventType}`, would use the {Match} and {Team} options from the respective endpoint in the table, and the {EventType} option from the fixed options. The {outletAuthKey}, on the other hand, is fetched from the [Provider](#) configuration in the Admin page.

- Once an endpoint is added to a dataset, you can select the endpoint card. This reveals the Endpoint parameters panel on the right side, where its properties can be entered. You can now edit the endpoint configuration (**Competition** and **Season**, as shown in the image below):



⌵ **Endpoint parameters**

**Competition** ⓘ

Liga Profesional Argentina, Argentina ▾

**Season** ⓘ

2023 ▾

⌵ **Processing parameters**

**Scripting**

None ▾ 🔍

⌵ **Dataset parameters**

**Flatten delimiter**

/

**Polling (s)**

3600

- To change the polling rate (how often the Stats Perform remote host is polled for data, in s) for the dataset, select a card from the list and edit the **Polling** field in the Dataset parameters on the right-most column.

⌵ **Dataset parameters**

**Flatten delimiter**

/

**Polling (s)**

3600

- When done, the data is added to the **Dataset output** table.

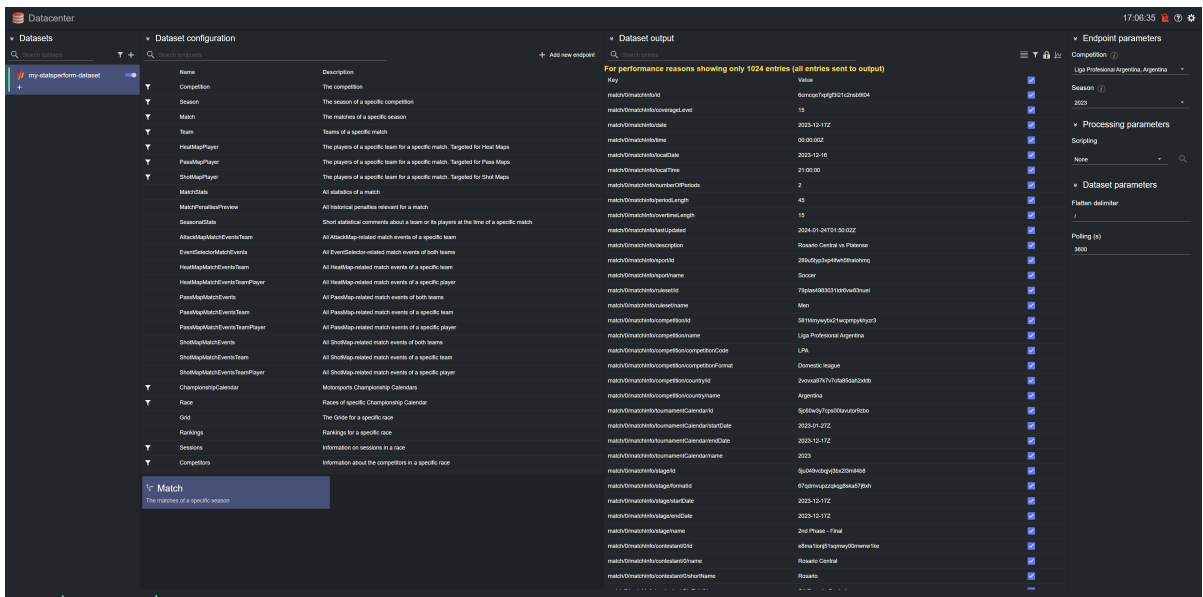

## Filtering a Dataset

Values read from a file into a dataset can be filtered via the Filtering tool. To do so, select the dataset card, click on the hamburger menu and then press the **Filter** button.



A dialog visualizing the file's payload schema opens, through which a user can filter the source data.

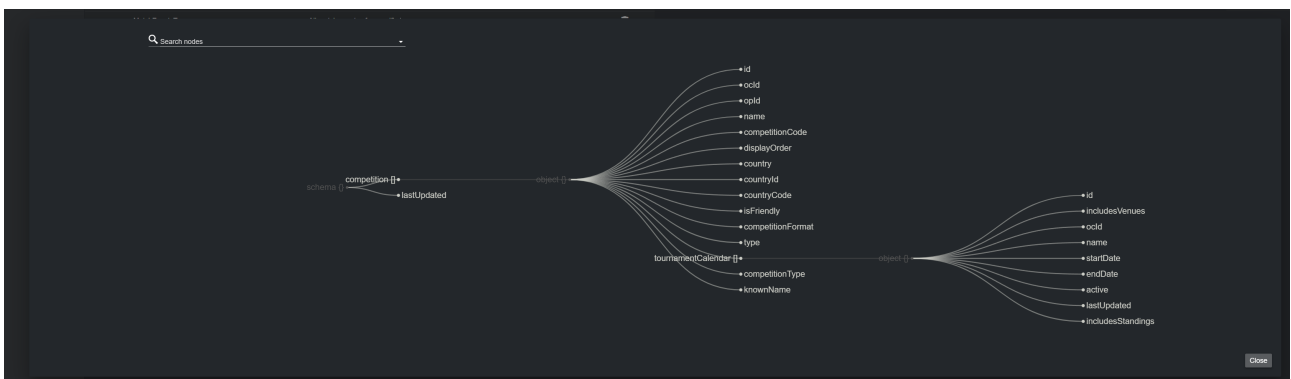

Please refer to the [Filtering and Manipulating a Dataset Entries](#) page to learn how to enable, disable and edit the entries added.

## Fluid Data Services Dataset

This section provides the steps to configure a **Fluid Data Services** dataset.

1. Create a new dataset of type **Fluid Data Services**, specifying a name and (optionally) a prefix to use to identify the dataset and its values, respectively:

The screenshot shows a 'New Dataset' configuration window. The title bar reads 'New Dataset my-fluid-dataset'. Below the title, there are three labeled input fields: 'Type' with a dropdown menu showing 'Fluid Data Services', 'Name' with the text 'my-fluid-dataset', and 'Prefix' with the text 'Prefix'. At the bottom of the window, there are two buttons: a red 'Cancel' button and a grey 'Add' button.

2. Click **Add**. The dataset is added to the list, and it has an initial WARNING status as it contains no configured endpoints yet.

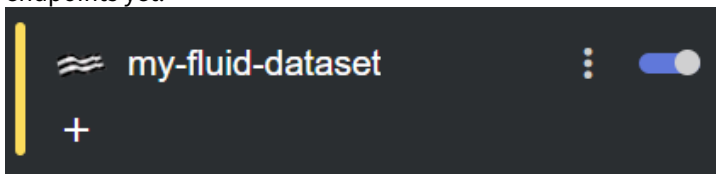

3. Select one or more endpoints from the table in the **Dataset configuration** panel by double clicking a row. A new endpoint card is then created.

Dataset configuration

Search endpoints + Add new endpoint

Name	Description
Sport	Available sports
Competition	Available competitions
EventGroup	Event group
Event	Event
Team	Team
Player	The players for a given team in a competition in a given year
Players passmap	The players passmaps for a given event
Players shotmap	The players shotmap for a given event
Penalty preview	The penalty preview for a given event
Attacks Distribution	The attacks distribution for a given event
Teams HeatMap	The heatmaps for the teams in a given event
Actors Details	The players details for a given team in a competition in a given year
Actors Stats	The players stats for a given event
Team Stats	The team stats for a given competition

Alternatively, you can enter a new endpoint by clicking **Add new endpoint** on the right-side of the panel, and then clicking on the empty endpoint that is added at the bottom of the table to configure it.

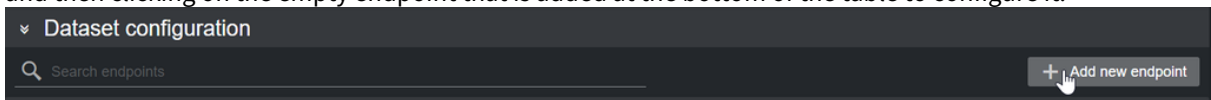

This reveals the new endpoint details, where its properties can be entered.

⌵ Endpoint template parameters

Name

Id\_14

---

Description

Description

---

Endpoint

---

Dependency filter

---

⌵ Endpoint fixed options

Name

---

**Endpoint Options:** When adding a new endpoint, parameters (for example, parts of the endpoint whose value should be fetched from other endpoints) should be encapsulated in curly braces: {part\_name}. The value inside curly braces is then resolved either using other endpoints present in the **Dataset configuration** table, or the ones specified in the **Endpoint fixed options** section of the main view. Using as example the images above, the following endpoint `/Competitions/{Competition}/{%year%}/teams/{Team}/actors`, would use the {Competition} and {Team} options from the respective endpoint in the table. The {%year%} option, on the other hand, is a special token used to list years as date.

- Once an endpoint is added to a dataset, you can select the endpoint card in the Dataset configuration panel. You can now edit the endpoint configuration (for example, **Sport**, **Competition** and **Year** shown in the picture below) in the Endpoint parameters panel on the right.

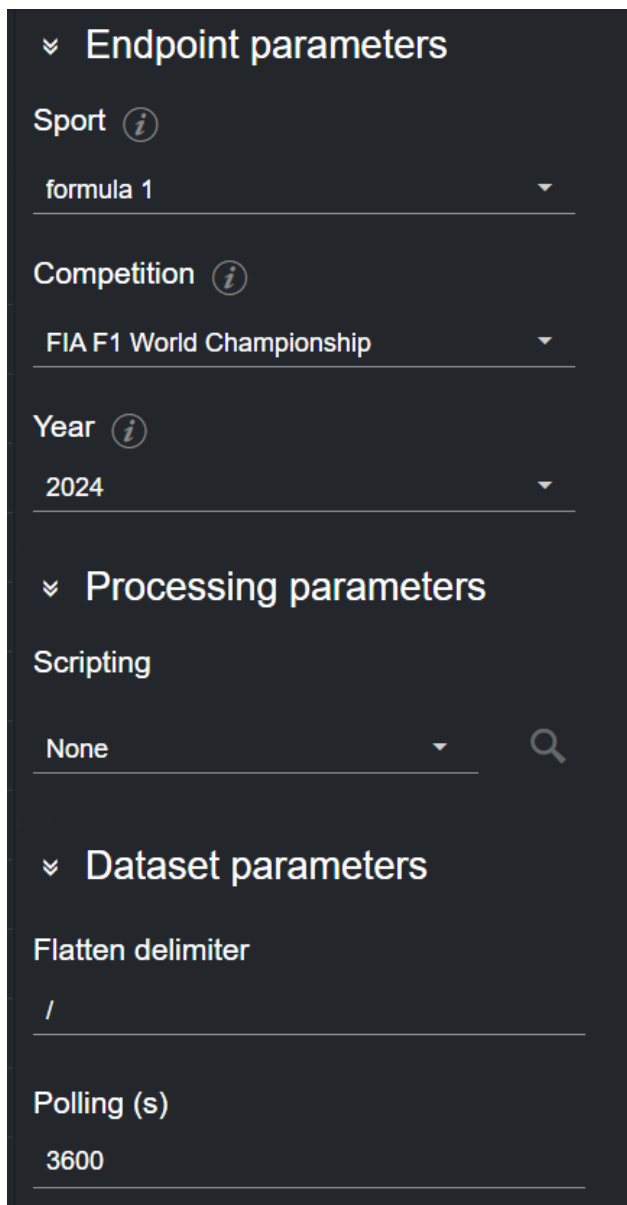

The image shows a dark-themed configuration panel with three main sections:

- Endpoint parameters:** Includes dropdown menus for 'Sport' (set to 'formula 1'), 'Competition' (set to 'FIA F1 World Championship'), and 'Year' (set to '2024').
- Processing parameters:** Includes a 'Scripting' dropdown menu set to 'None' with a search icon to its right.
- Dataset parameters:** Includes a 'Flatten delimiter' text field containing '/' and a 'Polling (s)' text field containing '3600'.

5. To change the polling rate (how often the Fluid remote host is polled for data, in s) for the dataset, select an endpoint card from the list and edit the **Polling** field in the Dataset parameters on the right-most column.

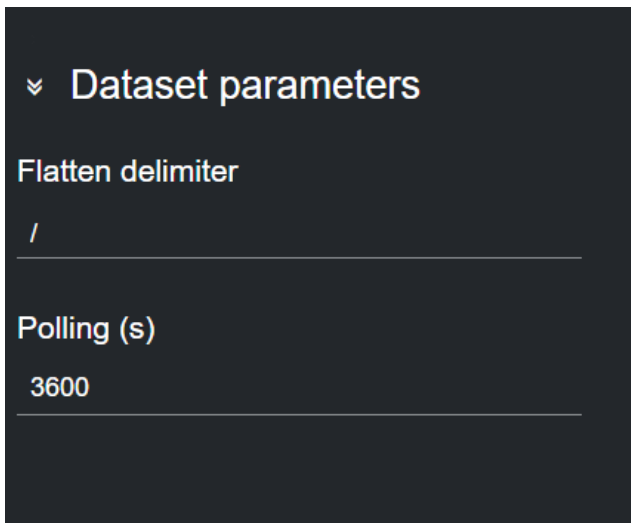

6. When done, the data is added to the **Dataset output** table.

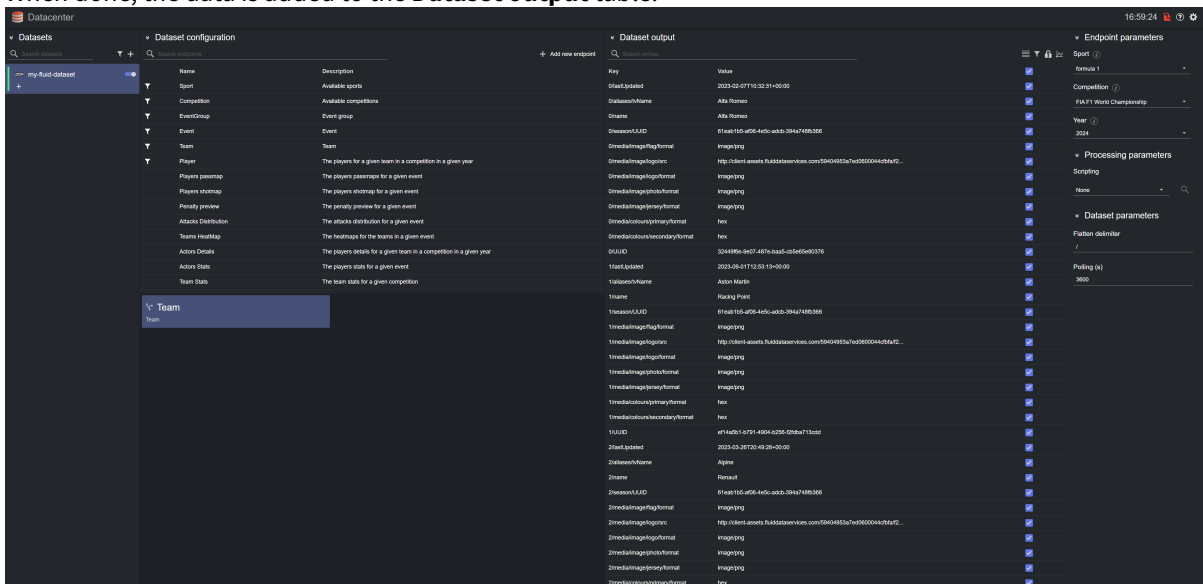

### Filter a Dataset

Values read from a file into a dataset can be filtered with the Filtering tool. To do so, select the dataset card, click on the hamburger menu and then press the **Filter** button.

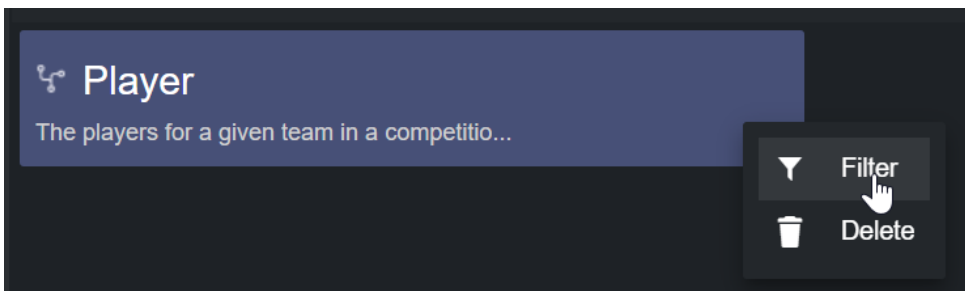

A dialog visualizing the file's payload schema opens, through which a user can filter the source data.

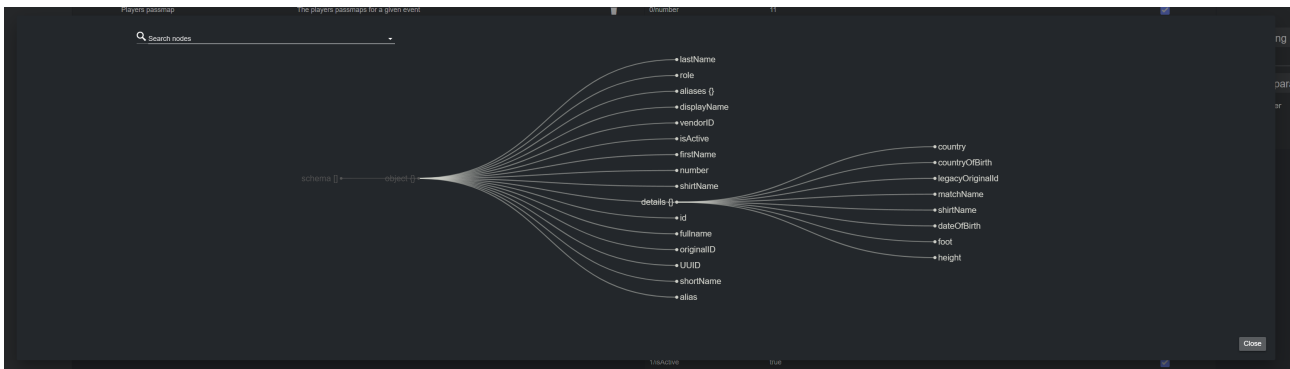

Please refer to the [Filtering and Manipulating a Dataset Entries](#) page to learn how to enable, disable and edit the entries added.



## Rest Webserver Dataset

This section provides the steps to configure a **Rest Webserver** dataset, to poll data from a generic REST provider.

1. Create a new dataset of type **Rest Webserver**, specifying a name and (optionally) a prefix to use to identify the dataset and its values, respectively:

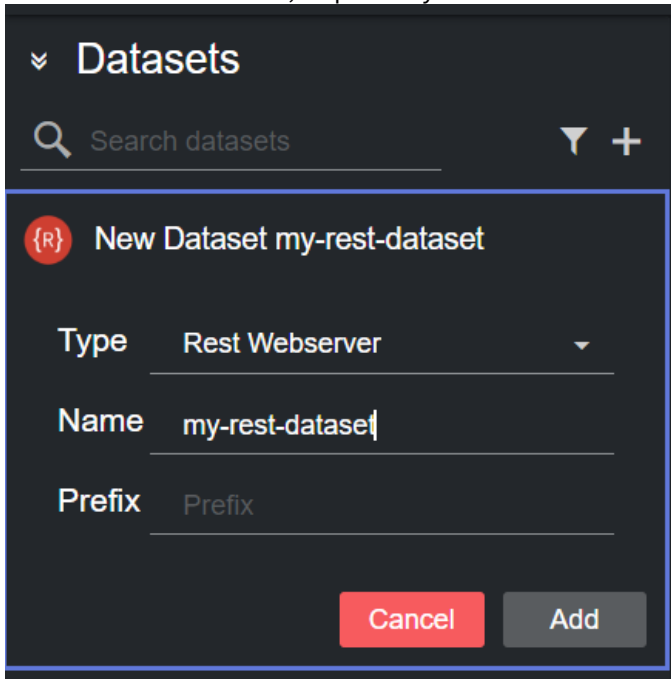

The screenshot shows a dark-themed interface for creating a new dataset. At the top, there's a 'Datasets' header with a search bar labeled 'Search datasets' and a filter icon. Below this, a red circle with a white '{R}' icon is next to the text 'New Dataset my-rest-dataset'. The form has three input fields: 'Type' with a dropdown menu set to 'Rest Webserver', 'Name' with the text 'my-rest-dataset', and 'Prefix' with the placeholder text 'Prefix'. At the bottom right, there are two buttons: a red 'Cancel' button and a grey 'Add' button.

2. Click **Add**. The dataset is added to the list, and it has an initial WARNING status as it contains no configured endpoints yet.

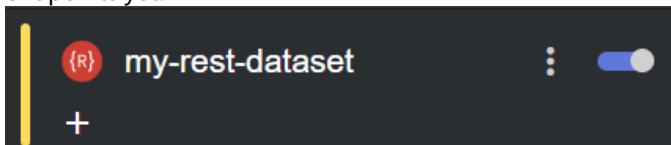

3. Click on the dataset card and configure the webservice options in the **Dataset parameters** section of the main UI./info

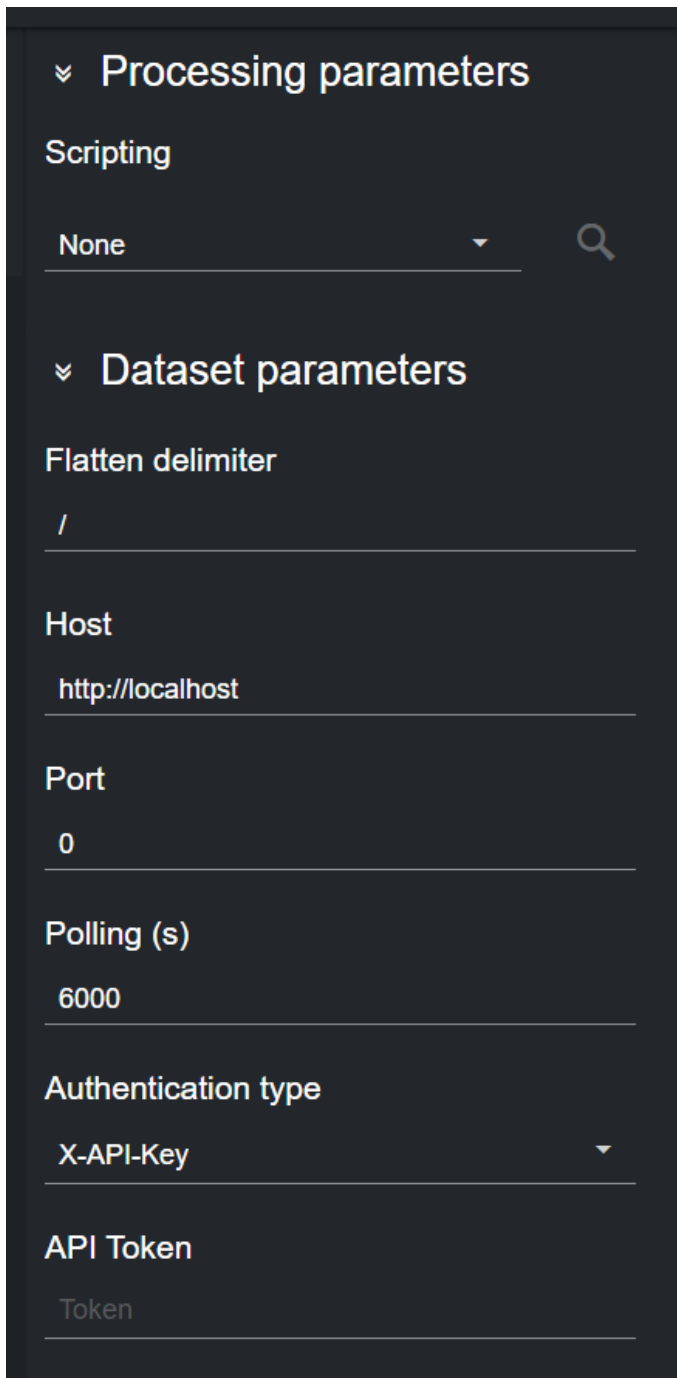

The image shows a dark-themed configuration interface. At the top, there is a section titled 'Processing parameters' with a downward arrow icon. Below this, the 'Scripting' section is visible, with a dropdown menu currently set to 'None' and a search icon to its right. The next section is 'Dataset parameters', also with a downward arrow icon. Under 'Dataset parameters', there are several fields: 'Flatten delimiter' with a value of '/', 'Host' with a value of 'http://localhost', 'Port' with a value of '0', 'Polling (s)' with a value of '6000', 'Authentication type' with a dropdown menu set to 'X-API-Key', and 'API Token' with a value of 'Token'.

If the host to connect to does not require a port to be specified, please leave the **Port** field as zero.  
If needed, use the **API Token** and **Authentication type** fields to specify how an API token should be passed in the request:

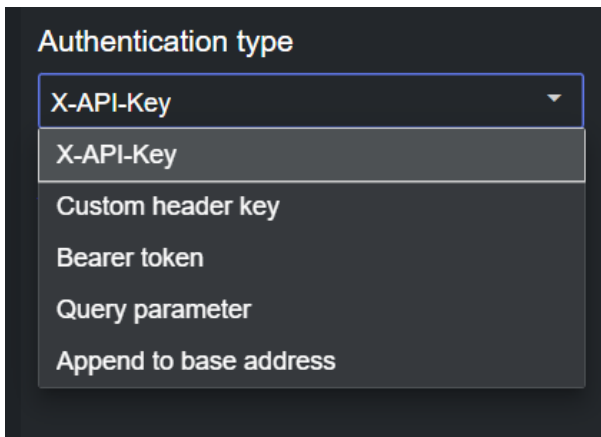

- **X-API-Key:** Embeds the API token in the *X-API-Key* key of the request header.
- **Custom header key:** Embeds the API token in the request header key specified in the **Custom Key** field.
- **Bearer token:** Embeds the API token in the *Authorization* key of the request header, and prefixes it with "Bearer".
- **Query parameter:** Embeds the API token in the query parameter specified in the **Custom Key** field.
- **Append to base address:** Appends the API token to the host address, for example <http://my-api-address/<my-api-key>>.

**Info:** More information on authentication and authorization can be found on the following link: <https://swagger.io/docs/specification/authentication/>.

4. Select one or more endpoints from the table in the **Dataset configuration** panel by double clicking a row. A new endpoint card is then created.

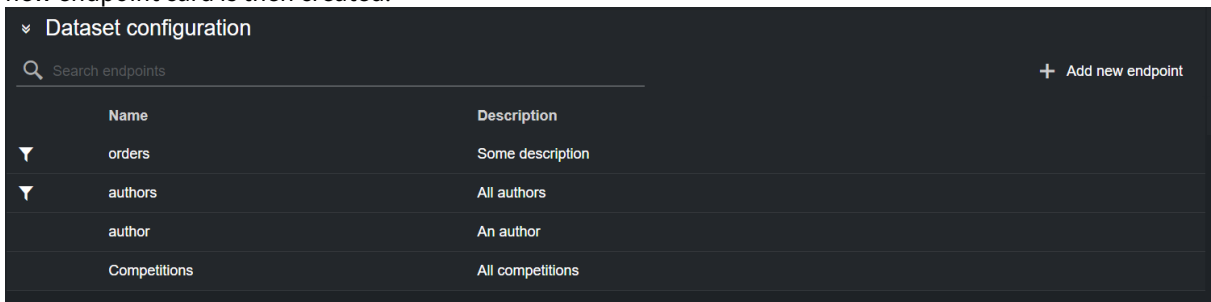

Alternatively, you can enter a new endpoint by clicking **Add new endpoint** on the right-side of the panel, and then clicking on the empty endpoint that is added at the bottom of the table to configure it.

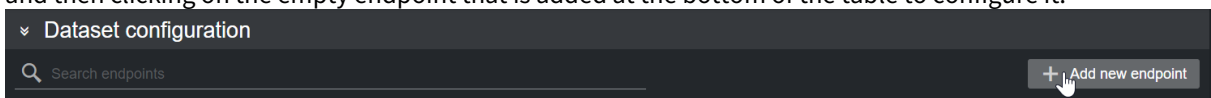

Doing so reveals the new endpoint details, where its properties can be entered.

⌵ Endpoint template parameters

**Name**

Id\_4

---

**Description**

Description

---

**Endpoint**

---

**Dependency filter**

---

⌵ Endpoint fixed options

Name

---

When adding a new endpoint, parameters (parts of the endpoint whose value should be fetched from other endpoints) should be encapsulated in curly braces: *{part\_name}*. The value inside curly braces is resolved either by using other endpoints present in the **Dataset configuration** table, or the ones specified in the **Endpoint fixed options** section of the main view.

Using as example the images above, when adding a new endpoint *"/authors/{authors}"*, the *{authors}* option would be resolved by using the endpoint named "authors" in the table to then present the user a dropdown with various authors to configure the newly added endpoint.

5. Once an endpoint is added to a dataset, you can select the endpoint card, where its properties can be entered. You can now edit the endpoint configuration.

⌵ Endpoint parameters

⌵ Processing parameters

Scripting

None  🔍

⌵ Dataset parameters

Flatten delimiter

/

Host

http://127.0.0.1

Port

8000

Polling (s)

3600

Authentication type

X-API-Key

API Token

Token

6. To change the polling rate (how often the remote REST host is polled for data, in seconds) for the dataset, select if from the list and edit the **Polling (s)** field in the **Dataset parameters** on the right-side column.

Dataset parameters

Flatten delimiter

/

Host

http://localhost

Port

0

Polling (s)

6000

Authentication type

X-API-Key

API Token

Token

7. When done, the data is added to the **Dataset output** table.

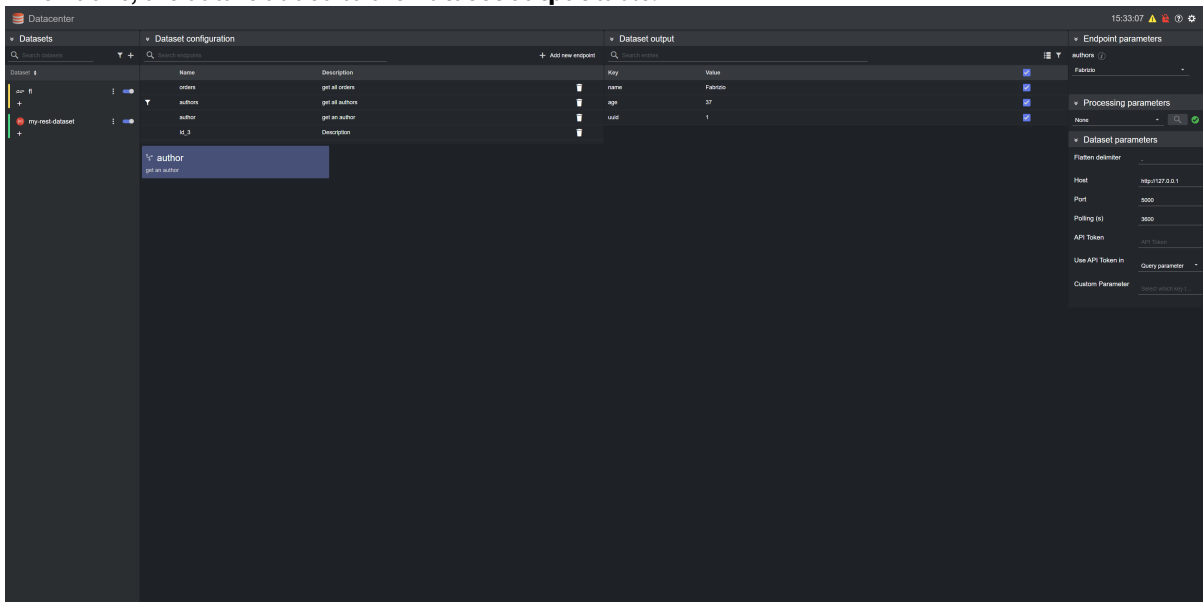

## Filter a Dataset

Values read from a file into a dataset can be filtered with the Filtering tool. To do so, select the dataset card, click on the hamburger menu and then press the **Filter** button.

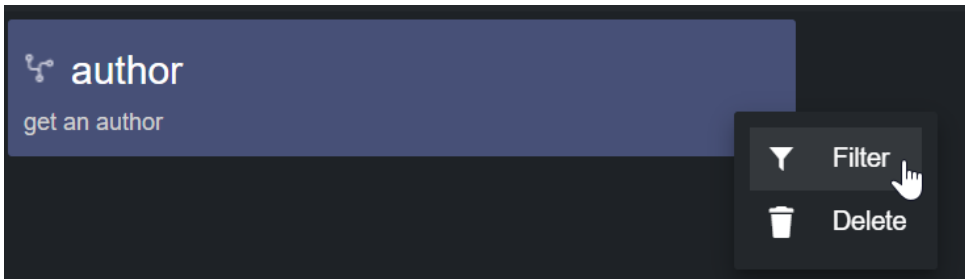

A dialog visualizing the file's payload schema opens, through which a user can filter the source data.

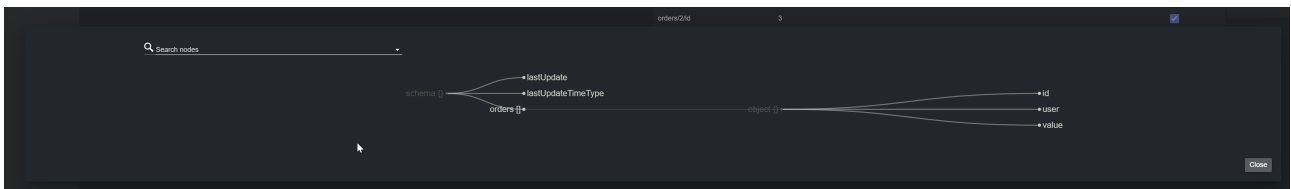

Please refer to the [Filtering and Manipulating a Dataset Entries](#) page to learn how to enable, disable and edit the entries added.

## Viz Data Connectors

For a Viz Data Connectors dataset to work correctly, an existing account with Flowics by Vizrt must be obtained (separately) by the customer. Additionally, the connectors to forward to Datacenter via the Flowics Middleware, as well as its setup, must be performed via the Flowics web-ui. Please refer to the [Flowics by Vizrt documentation](#) for further information on how to install the Flowics Middleware.

**Note:** The Viz Data Connectors integration requires Datacenter to run in HTTPS mode. Please refer to the [General Configuration](#) page for instructions on how to setup a HTTPS service.

This section provides the steps to configure a [Viz Data Connectors](#) dataset using [Flowics Middleware](#).

1. Create a new dataset of type **Viz Data Connectors**, specifying a name and (optionally) a prefix to use to identify the dataset and its values:

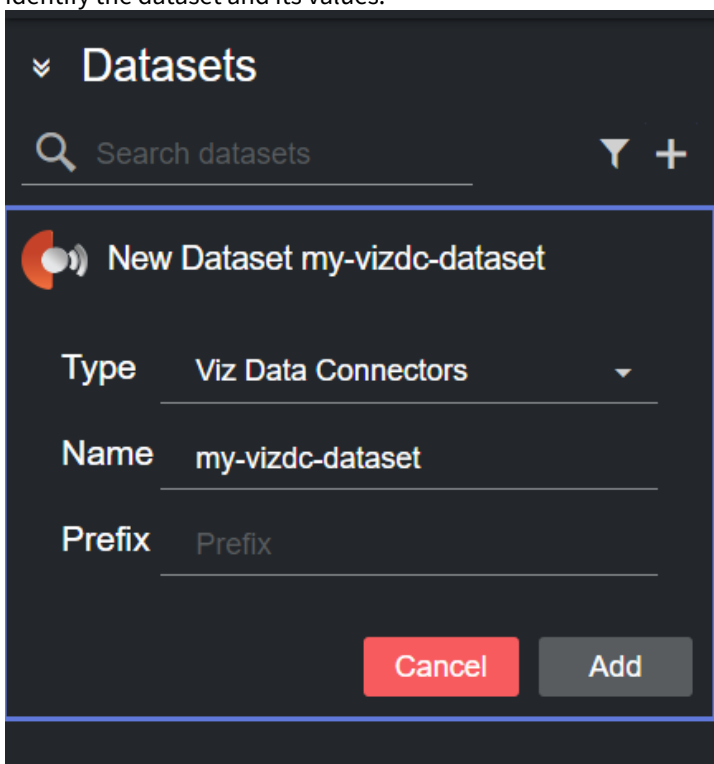

The screenshot shows a dark-themed interface for creating a new dataset. At the top, it says 'Datasets' with a search bar and a filter icon. Below that, a modal window titled 'New Dataset my-vizdc-dataset' is open. It contains three fields: 'Type' with a dropdown menu showing 'Viz Data Connectors', 'Name' with the text 'my-vizdc-dataset', and 'Prefix' with the text 'Prefix'. At the bottom of the modal are two buttons: a red 'Cancel' button and a grey 'Add' button.

2. Click **Add**. The following link is displayed in the **Dataset configuration** panel:

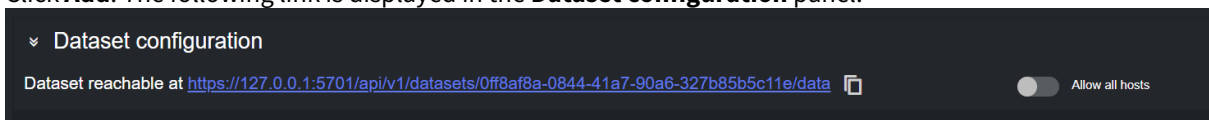

The screenshot shows a dark-themed 'Dataset configuration' panel. It displays the text 'Dataset reachable at <https://127.0.0.1:5701/api/v1/datasets/0ff8af8a-0844-41a7-90a6-327b85b5c11e/data>' followed by a copy icon. To the right of this text is a toggle switch labeled 'Allow all hosts', which is currently turned off.

This link can be used in the Flowics web-ui, [to configure the Middleware to forward data to Datacenter](#).

The basic setup assumes that both Datacenter and the Flowics Middleware run on the same machine. When this is the case, no further steps are required to setup a Flowics dataset, and any data configured to be forwarded by the Middleware, should also appear in the Dataset Entries panel. However, for setups where Datacenter runs on a different machine than the Flowics Middleware, the following additional steps have to be performed:

1. In Datacenter's **Dataset configuration** panel, enable the **Allow all hosts** toggle.



- a. Substitute the *localhost/127.0.0.1* part of the address shown in the **Dataset configuration** panel with the machine public IP, and use this new address to configure the Middleware to forward data to Datacenter.

**Info:** On Windows, a machine IP can be found by running the *ipconfig* command from a command line terminal (CMD), or the *Get-NetIPAddress* cmdlet in Powershell.

Please refer to the [Filtering and Manipulating a Dataset Entries](#) page to learn how to enable, disable and edit the entries added.

## Configuring Middleware to Send Data to Datacenter

**Note:** This guide assumes the Flowics Middleware has been installed on a machine in the following location: */home/user/dev/middleware-cli*. Please refer to the [Flowics by Vizrt documentation](#) for further information on how to install the Fowics Middleware.

### Middleware Token

**Note:** The token used when configuring Middleware can be found in the Flowics web-ui, under **Settings** → **Middleware** → **General Settings** → **Token**. This value needs to be associated to the entry *flowics.middleware.id* in the file *middleware.properties*, **found in /home/user/dev/middleware-cli/conf**.

The Middleware can be accessed via the [Flowics platform](#). For that, a registered user account is required.

To start sending data to Datacenter:

- Once logged in, navigate to **Data Connectors** → **Data Middleware Sources** and select the source from the list where relaying to Datacenter needs to be enabled.
- On the Data Source page, locate the **Middleware Integration** section and click on the Edit button. In the dialog that opens, make sure to enable **Push to an HTTP Webhook** and in the **Endpoint** input the Datacenter dataset link shown in the **Dataset configuration** panel.

**Info:** If the Middleware runs on a separate machine than the one running Datacenter, substitute the *localhost/127.0.0.1* part of the address in the **Dataset configuration** panel, with the machine public IP.

**Edit Middleware integration** ✕

Enable this Middleware Datasource

Middleware

Vizrt - Zurich - A

---

**Integration strategies**

Write to a file

Push to an HTTP Webhook

Endpoint

Method

- Click **Save**. The configuration should be downloaded to the Middleware, and shortly after the dataflow should start towards Datacenter.

### Using Signed Certificates

**Note:** Please refer to the [General Configuration](#) page for instruction on how to setup Datacenter to run as an HTTPS service.

The Flowics Middleware requires Datacenter to run an HTTPS service to correctly forward data to it. Please note that Datacenter does not provide signed certificates. Should you not already have a certificate-authority provided certificate, there are several services that can issue signed certificates (for example, [letsencrypt.org](https://letsencrypt.org)). When using a TLS certificate signed by a valid authority, no further steps are required to integrate Middleware to Datacenter (this is the recommended way to integrate both).

## Using Self-Signed Certificates

### Editing a Trust Store

**Warning:** The following guide requires you to edit the **Java Virtual Machine** (JVM) trust store. This can potentially expose your machine to malicious actors and attacks, therefore, we recommend carrying the following steps with care. Please have your IT team assist you during this process.

In case you are not able to obtain a certificate-authority provided certificate, a self-signed certificate can be used to run Datacenter as an HTTPS service. This, however, is not the recommended way to setup Datacenter in HTTPS mode, and should only be done under the supervision of your IT team and following an informed decision to use self-signed certificates.

While self-signed certificates are easy to obtain, they do not provide any trust value, and are therefore rejected by default by many communicating actors, including Flowics Middleware. To allow the Middleware to accept self-signed certificates from Datacenter, some additional work is required.

**Note:** Please refer to the [General Configuration](#) page for instructions on how to create a self-signed certificate.

**Info:** This guide assumes the JVM used to run Middleware is installed in `/home/user/jre-21`, while Flowics Middleware is installed in `/home/user/dev/middleware-cli`.

To enable Middleware to accept self-signed certificates, one needs to ensure that:

- The self-signed certificate is imported in the **Java Virtual Machine** (JVM) trust store.
  - We **strongly recommend** to first create a copy of the default JVM trust store, and add the self-signed certificate to the copy **only**. This prevents making permanent changes to the machine's trust store

**Warning:** Avoid changing the default JVM trust store, instead, work on a copy. We strongly recommend to carry out this step only under the supervision of your IT team.

- If a copy of the JVM trust store has been used (for example, in `/home/user/jre-21/cacert_bk/cacerts`), Middleware needs to be made aware of its location. This can be done by adding a line pointing to the modified trust store in the config file `/home/user/dev/middleware-cli/conf/middleware.conf`. To do so, open this config file and replace the line starting with `wrapper.java.additional.6` with the following line:

```
wrapper.java.additional.6=-Djavax.net.ssl.trustStore=/home/user/jre-21/cacert_bk/cacerts
```

```
# Java Additional Parameters
wrapper.java.additional.1=-client
wrapper.java.additional.2=-Djava.net.preferIPv4Stack=true
wrapper.java.additional.3=-Dsun.net.inetaddr.ttl=0
wrapper.java.additional.4=-Djava.io.tmpdir=tmp/
wrapper.java.additional.5=-Dwebapp.env_override=true
wrapper.java.additional.6=-Djavax.net.ssl.trustStore=/home/user/jre-21/cacert_bk/cacerts
#wrapper.java.additional.6=-Djava.security.policy=conf/policy.all
#wrapper.java.additional.7=-Dcom.sun.management.jmxremote
#wrapper.java.additional.8=-Dcom.sun.management.jmxremote.port=8997
#wrapper.java.additional.9=-Dcom.sun.management.jmxremote.authenticate=false
#wrapper.java.additional.10=-Dcom.sun.management.jmxremote.ssl=false
```

- Create an alias for the IP address of the machine running Datacenter by opening the operating system hostfile `/etc/hosts` file and adding the line (assuming Datacenter runs at 1.2.3.4:5701):

```
1.2.3.4 YOUR_DATACENTER_HOST_NAME
```

**Note:** The `YOUR_DATACENTER_HOST_NAME` value, **must** match the CN field listed in the self-signed certificate used on the Datacenter machine.

**Info:** Typically, the hostfile in the Windows installation can be located under `C:\windows\system32\drivers\etc`, while in Linux, the same file can be found in `/etc/hosts`.

**Warning:** We strongly recommend to carry out this step only under the supervision of your IT team.

- Finally, restart Middleware.

## Manual Dataset

These are the steps to configure a **Manual** dataset:

1. Create a new dataset of type **Manual**, specifying a name and (optionally) a prefix to use to identify the dataset and its values, respectively:

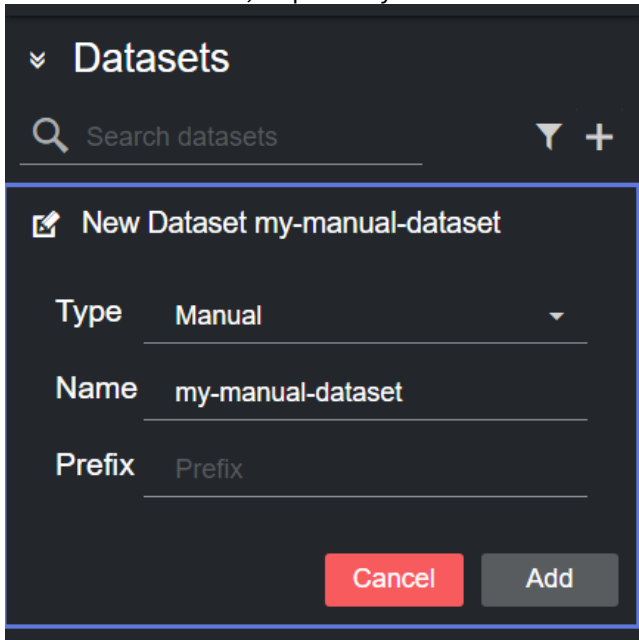

2. Click **Add**. You can now manually add new key-value data entries that work together with other datasets.
3. In the **Dataset Output** panel, click on the + button:

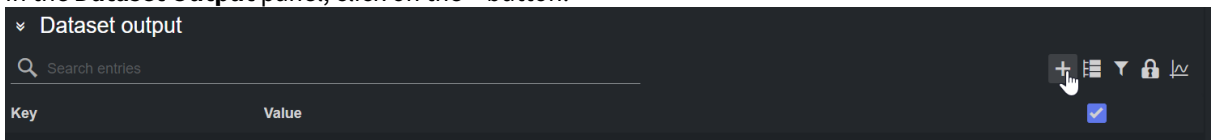

4. Fill the **Key/Value** pair in the panel that just opened. You can toggle the start activation state of the entry by using the toggle .

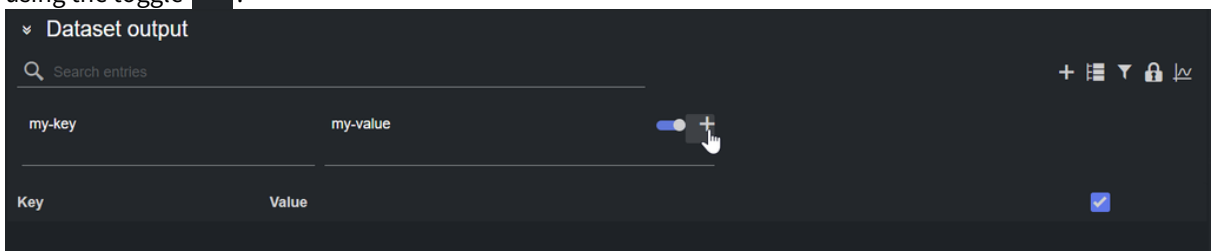

5. Click the plus  button to add the value to the entries. You should see the entry listed in the table below.

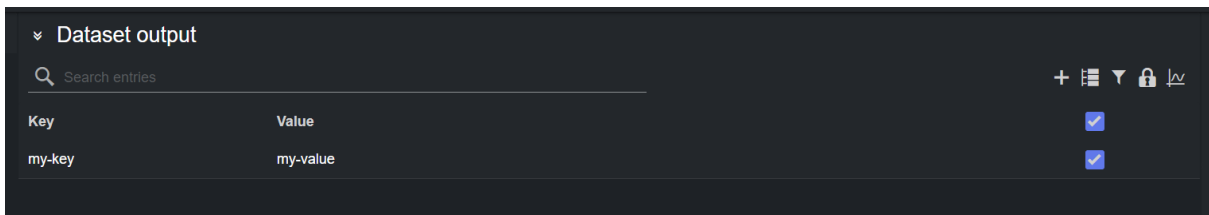

The screenshot shows a dark-themed interface for a 'Dataset output'. At the top left, there is a dropdown arrow and the text 'Dataset output'. Below this is a search bar with a magnifying glass icon and the placeholder text 'Search entries'. To the right of the search bar are several icons: a plus sign, a list icon, a funnel icon, a lock icon, and a link icon. Below the search bar is a table with two columns: 'Key' and 'Value'. The first row contains 'my-key' and 'my-value'. To the right of each row is a blue checkmark icon.

Key	Value	
my-key	my-value	<input checked="" type="checkbox"/>

Please refer to the [Filtering and Manipulating a Dataset Entries](#) page to learn how to enable, disable and edit the entries added.

## File Dataset

This section provides the steps to configure a **File** dataset.

1. Create a new dataset of type **File**, specifying a name and (optionally) a prefix to use to identify the dataset and its values, respectively:

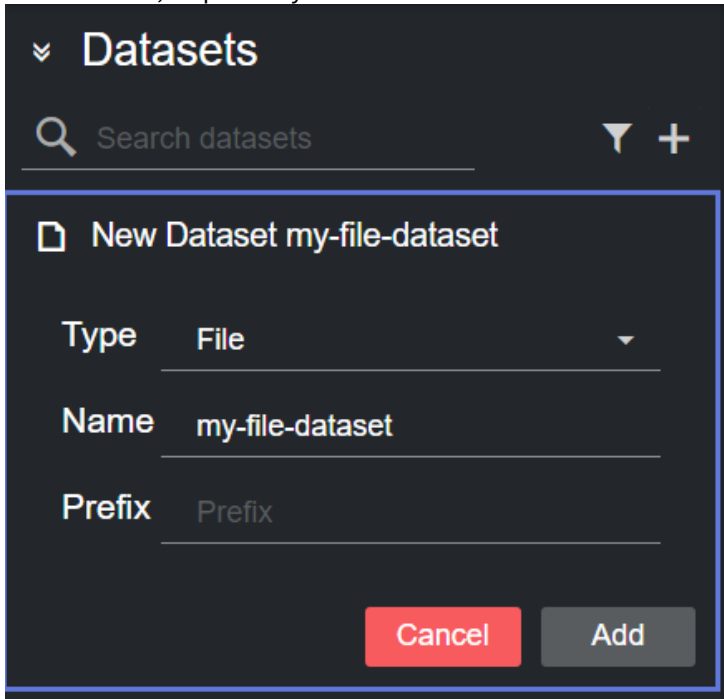

2. Click **Add**. The dataset is added to the list, and it has an initial WARNING status as it contains no source file yet.

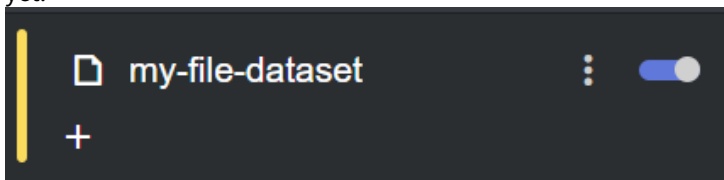

3. You can now select a source file from the table in the **Dataset configuration** panel, by double clicking one of its rows. The table lists all recently used files.

Name	Description	File
TXT file	A TXT example	data/example.txt
JSON file	A JSON example	data/fluid/Sport.json
CSV file	A CSV example	data/username.csv

Alternatively, you can type a file location in the input box at the top of the table and press the plus sign. The file is added to the dataset source, and included in the Files table for future reference.

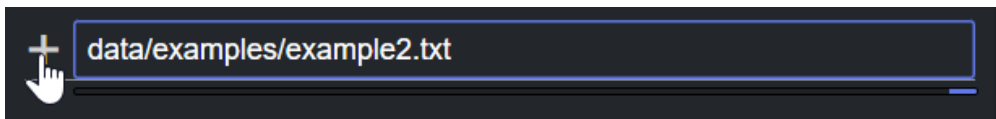

The input box supports autocomplete, listing the files in the folder alias that were setup while configuring the File provider in the [Admin](#) page.

Datacenter supports the following file types:

- a. **Text** (These are key-value pairs, using the '=' or ':' char as separators. The separators can be mixed.)
- b. **Ini-file**
- c. **JSON**
- d. **CSV** (comma-separated)

#### TXT files

TXT files accept two separators: '=' or ':', which can be mixed. White space added *after* the separator, is preserved in the *value*. White space added *before* the separator is stripped from the *key*.

### Editing Recently Added Files

The table in the **Dataset configuration** panel lists all the recently added files. When adding a file, its values are set to default.

Follow these steps to edit those properties:

1. Click on the file you want to edit, the corresponding row is highlighted in blue:

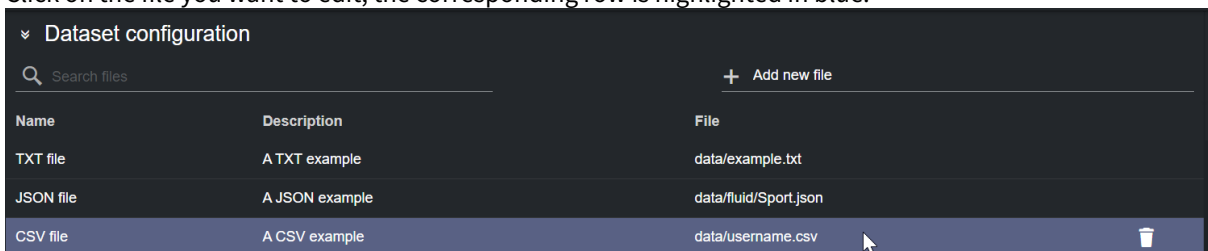

2. Edit the properties listed, such as **Name** and **Description**.

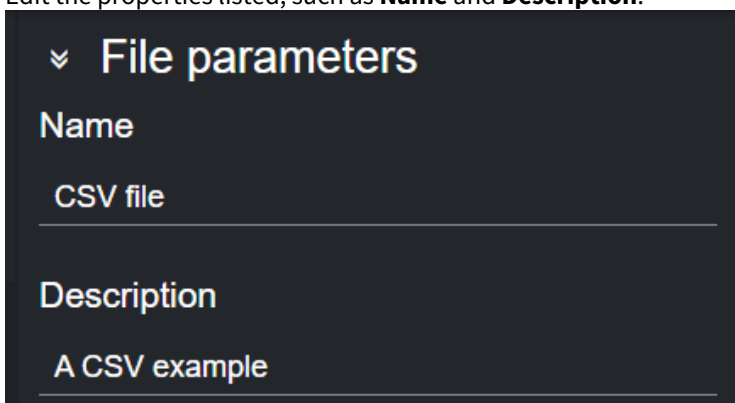



## Working with CSV Files

When adding a CSV file, Datacenter attempts to read the keys from the first column in the file, and the values from the second.

To change this behavior, click on the filename in the Dataset Configuration panel:

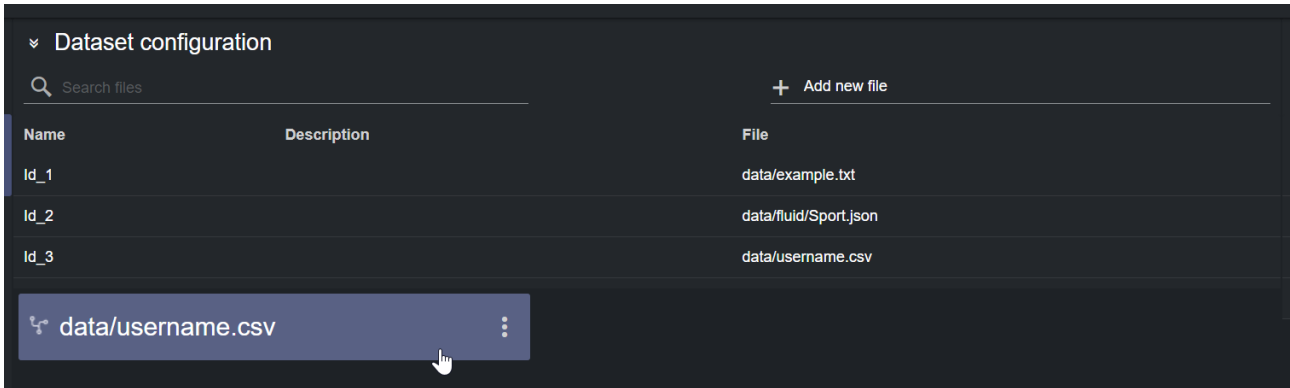

Change the **Keys Column** or **Values Column** options in the Setup Panel.

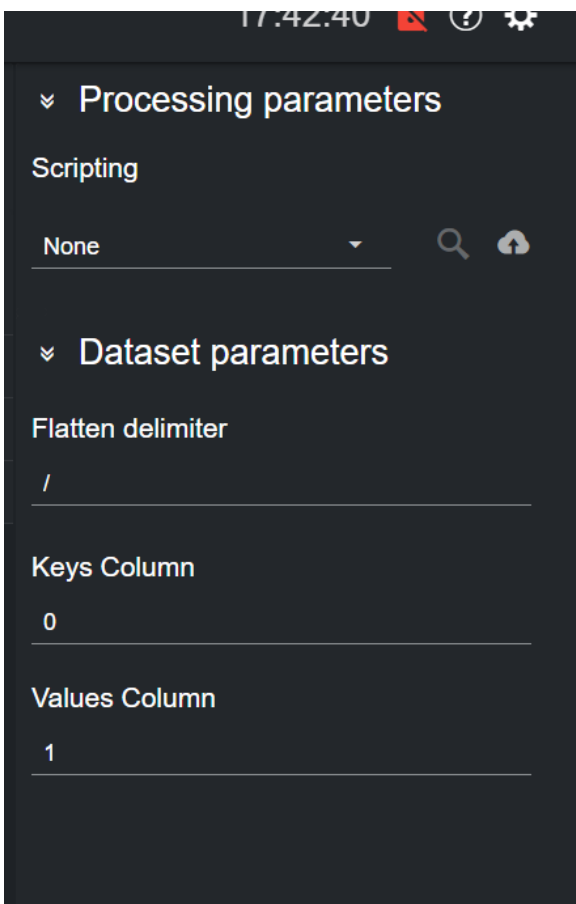

## Filtering a Dataset

Values read from a file into a dataset, can be filtered via the Filtering tool. To do so, select the dataset card, click on the hamburger menu and then press the **Filter** button.

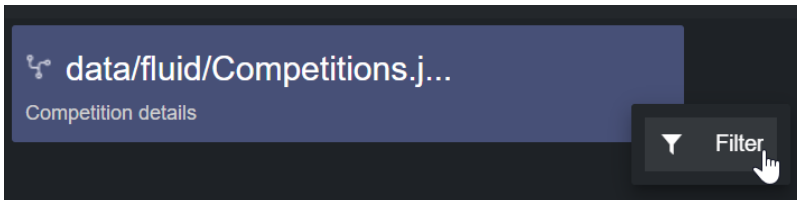

A dialog visualizing the file's payload schema opens, where a user can filter the source data.

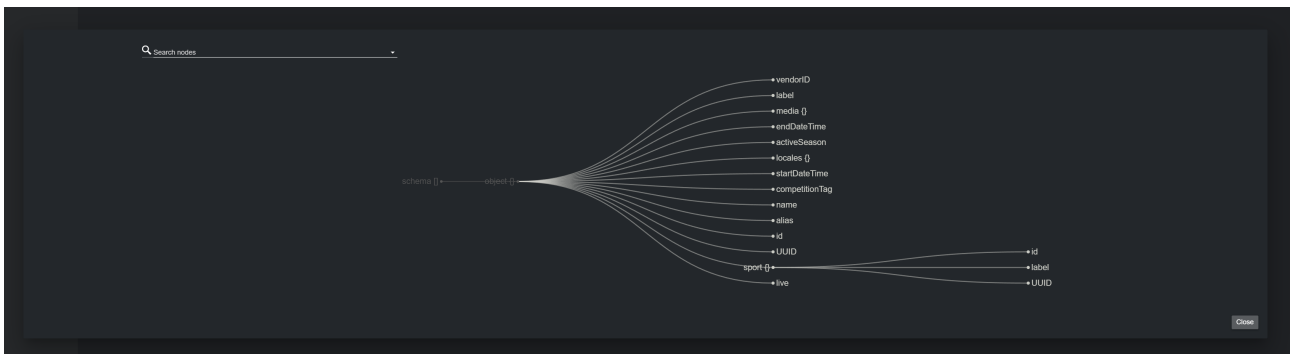

Please refer to the [Filtering and Manipulating a Dataset Entries](#) page to learn how to enable, disable and edit the entries added.

## Replicator Dataset

Datacenter supports datasets of type **Replicator**, and such data can be used to use one Datacenter as input for another.

This is particularly useful when a Datacenter machine has to be removed from public internet, but still needs to fetch data from an online Provider. In this scenario, a Datacenter machine can be connected to the internet and the provider, and the protected machine, not on the internet but reachable from the first machine, setup with one or more Replicator datasets pointing to the online machine.

**Info:** For security reasons, to allow a Datacenter service to be reachable by other machines, a [HTTPS certificate must be correctly configured](#). Therefore, currently only Datacenter machines that run a secure (HTTPS) service can be replicated. A service running an unsafe HTTP service can still be replicated, but only on the localhost (on the same machine).

**Note:** When connecting to a Datacenter service that runs as HTTPS, the certificate used on that machine must be valid, signed by an authority and in general, must pass a standard authentication procedure. Failing to do so, may result in the connection to that machine being refused by the connecting Replicator dataset, due to security issues.

Follow these steps to configure a Replicator dataset:

1. Create a new dataset of type **Replicator**, specifying a name and (optionally) a prefix to use to identify the dataset and its values:

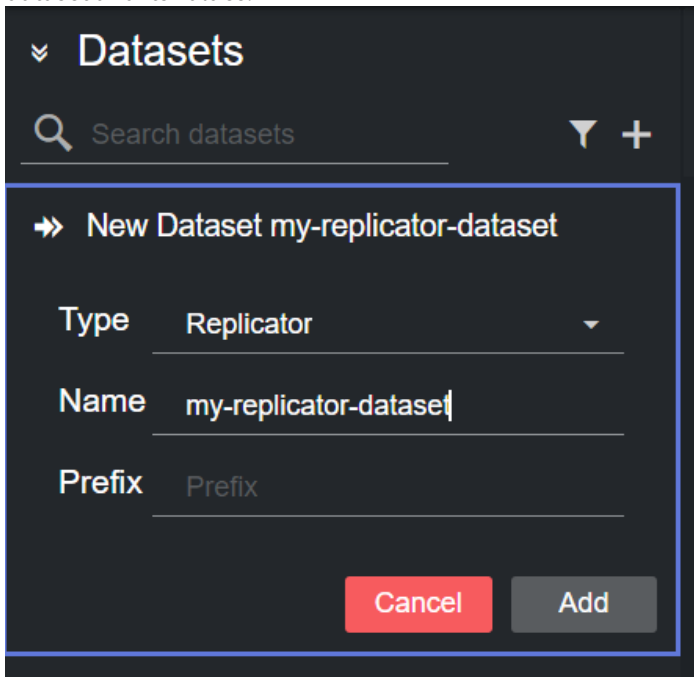

The screenshot shows a 'New Dataset' configuration window. At the top, it says 'Datasets' with a search bar containing 'Search datasets'. Below that, the title is 'New Dataset my-replicator-dataset'. There are three input fields: 'Type' with a dropdown menu set to 'Replicator', 'Name' with the text 'my-replicator-dataset', and 'Prefix' with the text 'Prefix'. At the bottom, there are two buttons: a red 'Cancel' button and a grey 'Add' button.

2. Click **Add**. The dataset is added to the list, and it has an initial WARNING status as it contains no dataset to replicate yet.

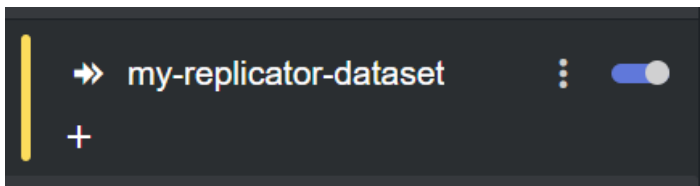

3. You can now select a host to replicate from the table in the **Dataset configuration** panel by double clicking a row. The table lists all the recently used hosts.

Dataset configuration

Search hosts + Add new host

Name	Description	Host	Port
My machine	127.0.0.1	localhost	5700
A remote machine	1.2.3.4	localhost	5700

Alternatively, you can add a new host by clicking on **Add new host** on the right-side of the panel, and then clicking on the empty host that is added at the bottom of the table.

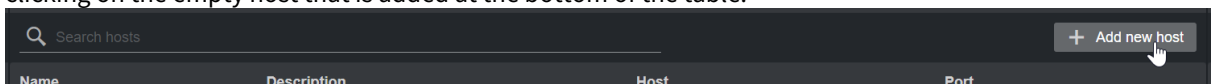

Doing so reveals the new host details, where its properties can be entered.

Host parameters

Name

Id\_6

---

Description

---

Host

---

Port

0

You can now double click on the configured host in the host table to select it as source to replicate.

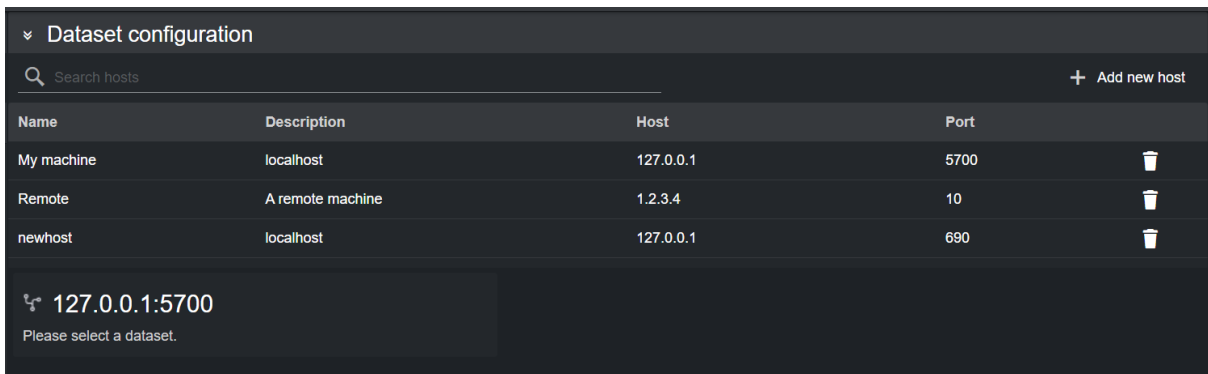

4. By clicking on the card in the Dataset configuration panel, the Dataset parameters will be shown on the right side of the screen

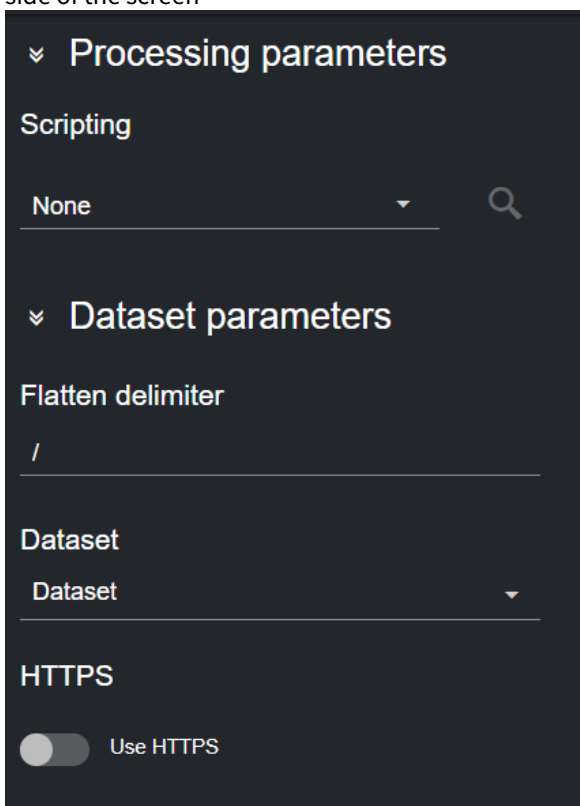

- a. The **HTTPS** toggle can be used to specify a host that runs an HTTPS Datacenter service.
- b. If the specified host runs a Datacenter, the datasets created on that machine are listed in the dropdown **Dataset** menu available in the **Dataset parameters** section.

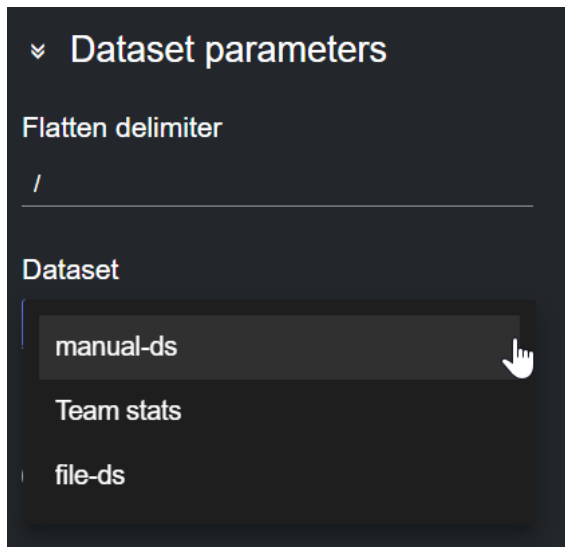

- After selecting a dataset, its entries are added to the **Dataset Entries** table. For example, the images below show a Replicator dataset (top) replicating entries from a Fluid dataset (bottom):

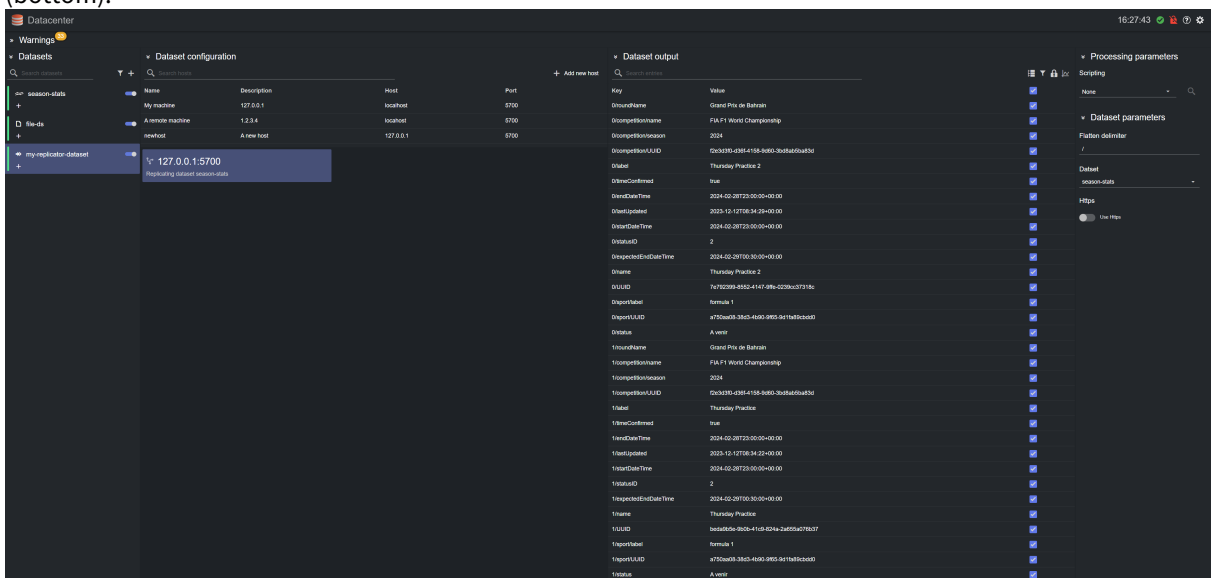

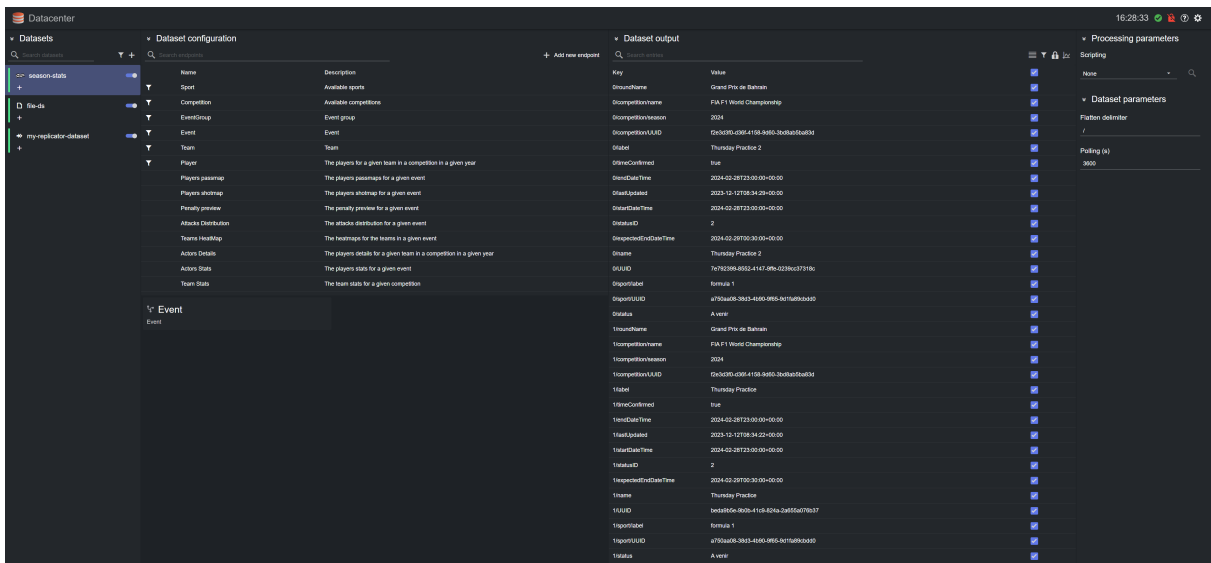

**Info:** When replicating a Dataset, each edit on the original dataset source (for example, disabling an entry or modifying a value) is immediately reflected in the Replicator dataset. Changes done on the Replicator dataset; however, do not reflect on the original source dataset.

Please refer to the [Filtering and Manipulating a Dataset Entries](#) page to learn how to enable, disable and edit the entries added.

## Sportzcast Dataset

This section provides the steps to configure a **Sportzcast** dataset.

1. Create a new dataset of type **Sportzcast**, specifying a name and (optionally) a prefix to use to identify the dataset and its values:

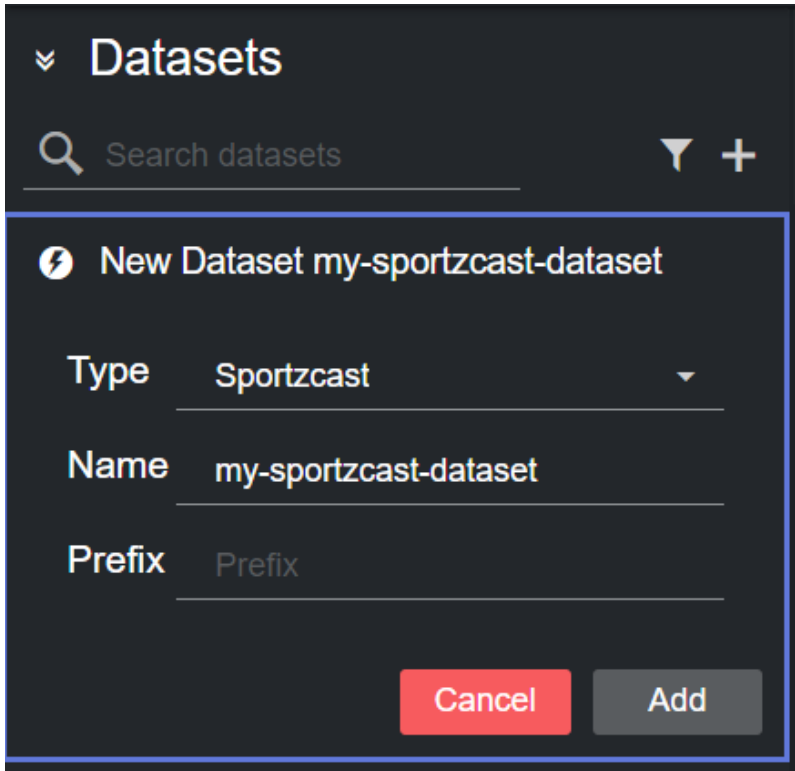

The screenshot shows a dark-themed interface with a 'Datasets' header and a search bar. A modal window titled 'New Dataset my-sportzcast-dataset' is open, containing the following fields:

- Type:** A dropdown menu set to 'Sportzcast'.
- Name:** A text input field containing 'my-sportzcast-dataset'.
- Prefix:** A text input field containing the placeholder text 'Prefix'.

At the bottom of the modal are two buttons: a red 'Cancel' button and a grey 'Add' button.

2. Click **Add**. The dataset is added to the list, and it has an initial WARNING status as it contains no source bots yet.

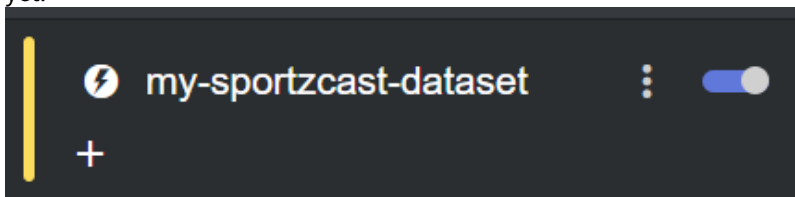

3. You can now select a bot from the **Bot** dropdown in the **Dataset parameters** panel:



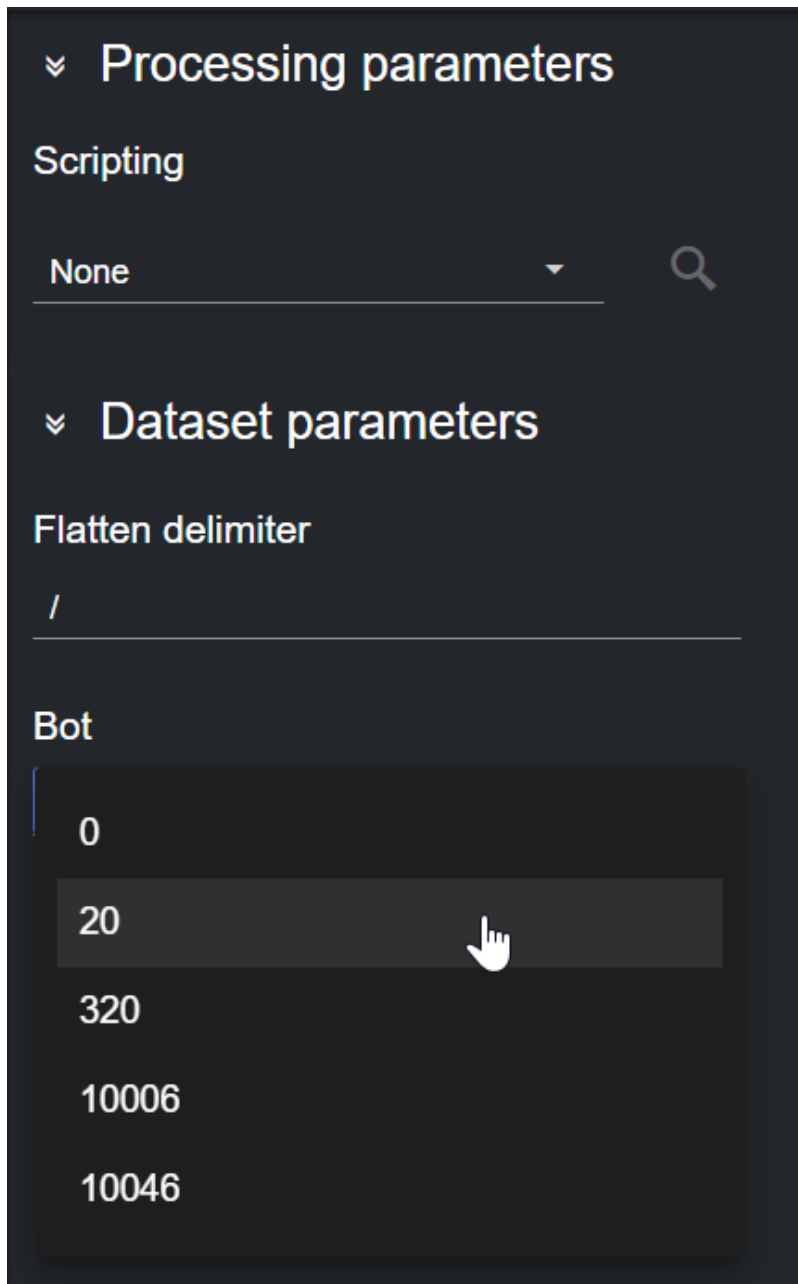

**Note:** In the Sportscast API, you are required to select the bot number that corresponds to a specific venue. These bots vary depending on the Sportscast bot server used while configuring the Provider in the [Admin](#) page.

After adding a source bot, its content is added to the **Dataset Entries** table.

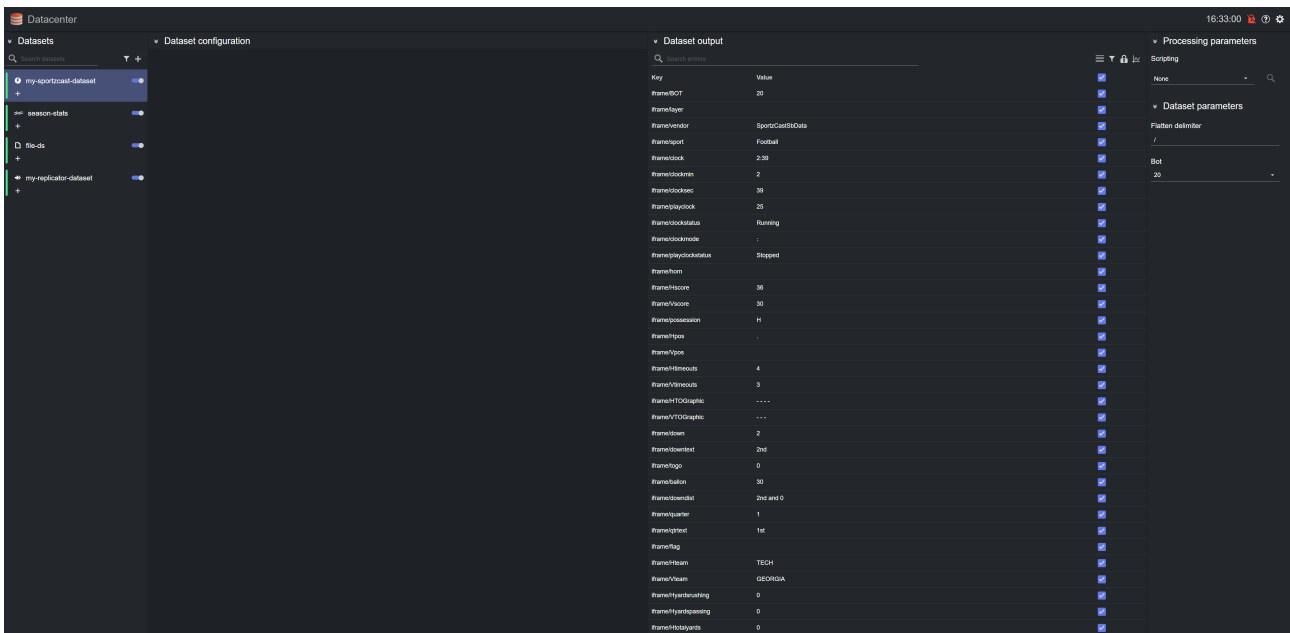

**Note:** Data from the Sportzcast data provider is event based, meaning that the data is pushed to Datacenter and the output is updated instantly when data changes.

Please refer to the [Filtering and Manipulating a Dataset Entries](#) page to learn how to enable, disable and edit the entries added.

## Tricaster Vectar

This section provides the steps to configure a **TriCaster Vectar** dataset, using **Datalink**.

Datalink in TriCaster Vectar allows live data input from a wide range of data sources, such as:

- Daktronics devices
- DSI devices
- Nevco devices
- OES devices
- Ranbow devices
- Translux devices
- Whiteway devices
- Access to all external databases (anything supported by ODBC).
- All sorts of internal clocks.
- External CSV files, Excel Files, Text files and XML files.
- Web based score controllers.
- Web page real-time updates.

The data is available in a TriCaster Vectar system, therefore, it can be used in Datacenter datasets.

Configuring a **TriCaster Vectar** dataset requires the following steps:

1. Create a new dataset of type **TriCaster Vectar**, specifying a name and (optionally) a prefix to use to identify the dataset and its values:

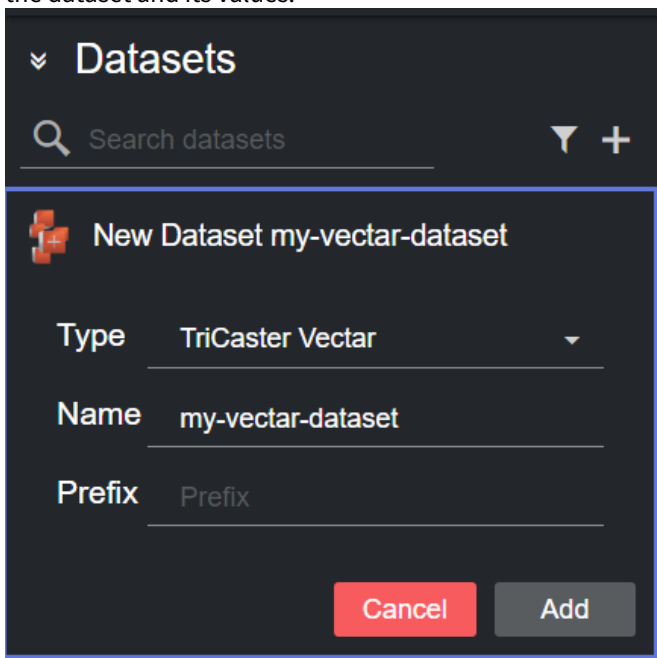

The screenshot shows a 'Datasets' interface with a search bar and a '+ New Dataset' button. A modal dialog titled 'New Dataset my-vector-dataset' is open, containing the following fields:

- Type:** TriCaster Vectar (dropdown menu)
- Name:** my-vector-dataset (text input)
- Prefix:** Prefix (text input)

At the bottom of the dialog are two buttons: 'Cancel' (red) and 'Add' (grey).

2. Click **Add**. The dataset is added to the list, and it has an initial WARNING status as it contains no source file yet.

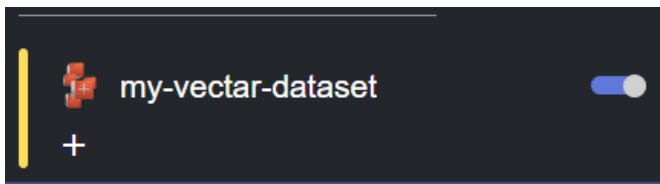

3. You can now select a host from the table in the **Dataset configuration** panel by double clicking a row. The table lists all the recently used hosts.

Dataset configuration

Search hosts + Add new host

Name	Description	Host	Port
bgomse	Veciar test server	bgomsevizeng3	80
bgomse_v2	Wrong port!	bgomsevizeng3	800

Alternatively, you can add a new host by clicking on **Add new host** on the right-side of the panel, and then clicking on the empty host that is added at the bottom of the table.

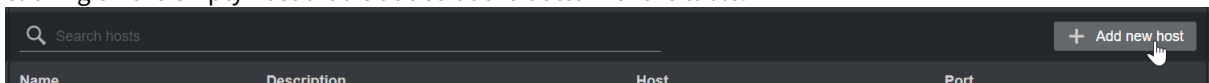

Doing so reveals the new host details on the right column, where its properties can be entered.

Host parameters

**Name**

Id\_11

---

**Description**

---

**Host**

---

**Port**

0

4. You can now double click on the configured host in the host table, to select a source.
4. After adding a host machine and establishing a successful connection to it, the data from the TriCaster Vector system is added to the **Dataset output** table.

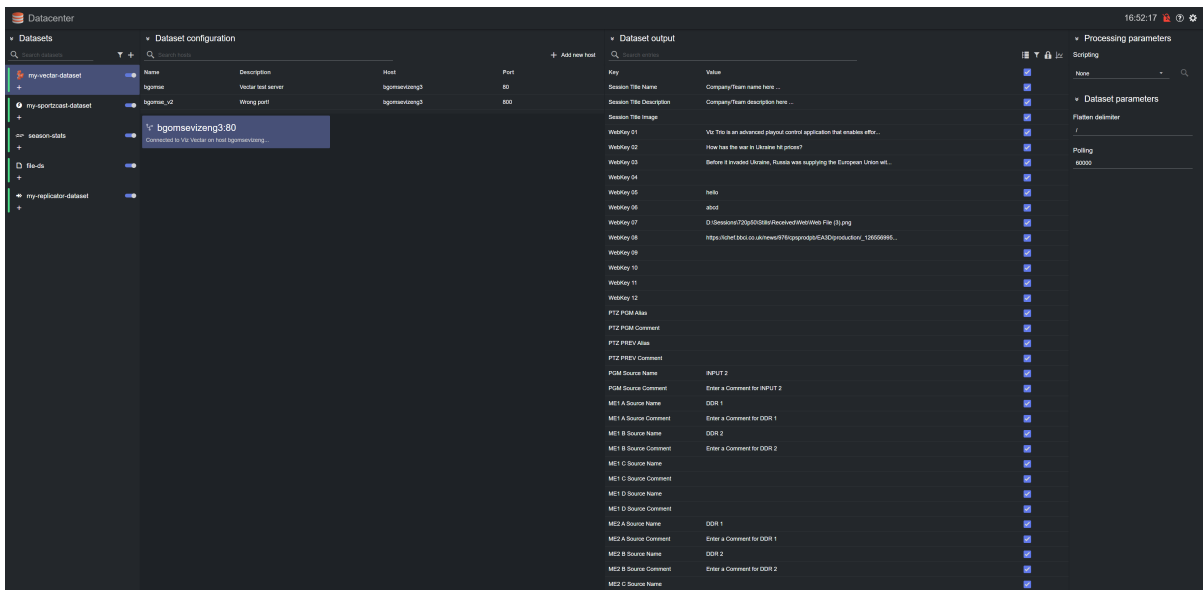

- To change the polling rate (how often the TriCaster Vectar host machine is polled for data, in s) for the dataset, click on the dataset card in the Dataset configuration panel and edit the **Polling** field in the **Dataset parameters**.

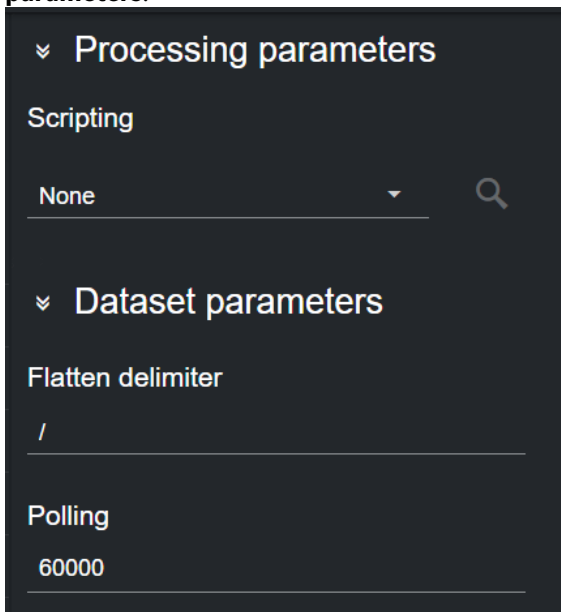

Please refer to the [Filtering and Manipulating a Dataset Entries](#) page to learn how to enable, disable and edit the entries added.

## Kafka Dataset

This section provides the steps to configure a **Kafka** dataset, which can be used to connect your outputs to data incoming from one of more [Apache Kafka](#) Brokers.

1. Create a new dataset of **Type** Kafka, specifying a name and (optionally) a prefix to use to identify the dataset and its values:

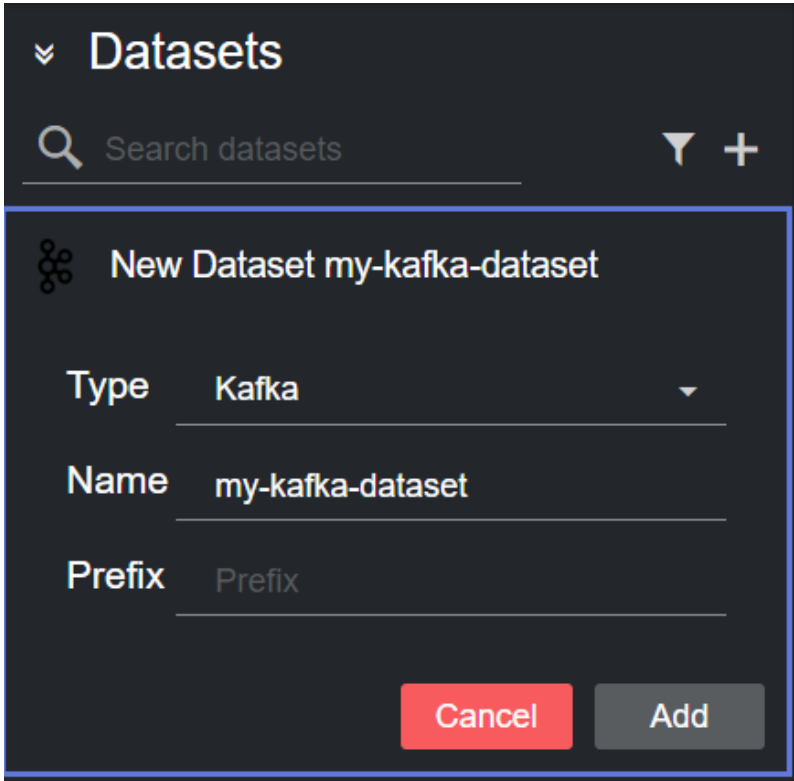

2. Click **Add**. The dataset is added to the list, and it has an initial WARNING status as it contains no Kafka broker source yet.

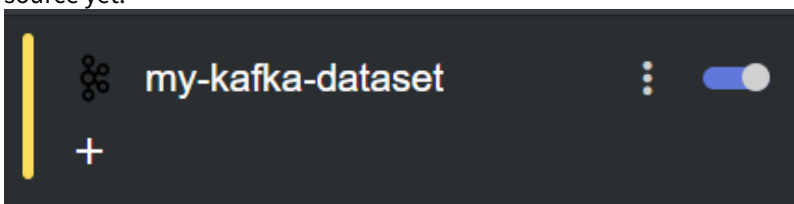

3. You can now select a host to replicate from the table in the **Dataset configuration** panel by double clicking a row. The table lists all the recently used hosts.

The screenshot shows the 'Dataset configuration' panel. It has a search bar labeled 'Search hosts' and a '+ Add new host' button. Below is a table with the following data:

Name	Description	Host	Port
Local_0	A kafka broker that runs locally	127.0.0.1	9000
Also_Local	A new Kafka broker	127.0.0.1	8080

Alternatively, you can add a new host by clicking on **Add new host** on the right-side of the panel, and then clicking on the empty host that is added at the bottom of the table.

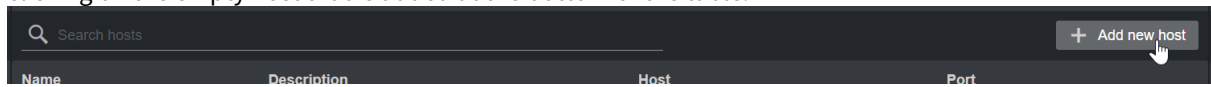

4. Doing so reveals the new host details, where its properties can be entered.

A screenshot of a dark-themed form titled 'Host parameters'. The form contains four input fields, each with a label and a value: 'Name' with the value 'Local', 'Description' with the value 'A new Kafka broker', 'Host' with the value '127.0.0.1', and 'Port' with the value '8080'. Each field is separated by a horizontal line.

5. If the specified host runs a Kafka Broker, the topics advertised by the broker are listed in the dropdown **Topics** menu available in the **Dataset parameters** section.

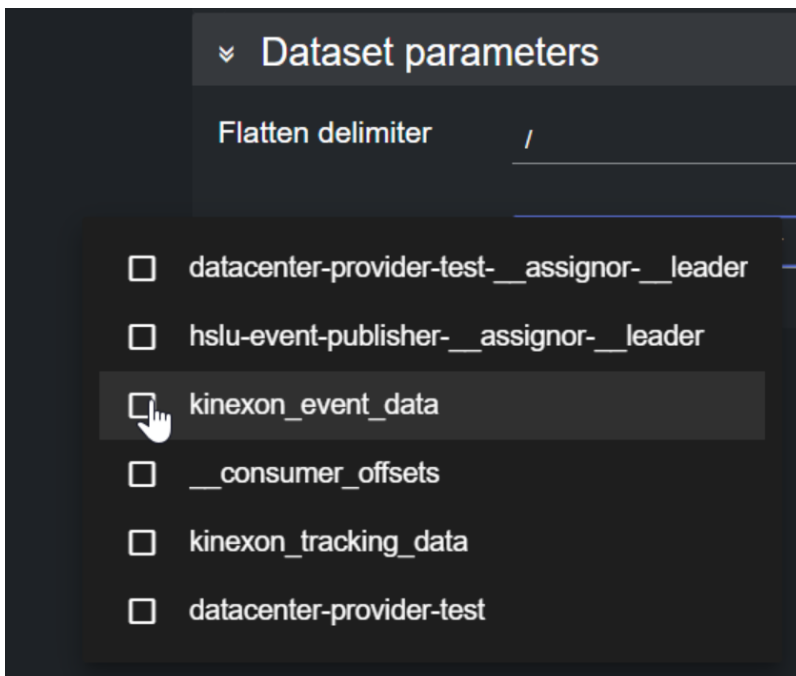
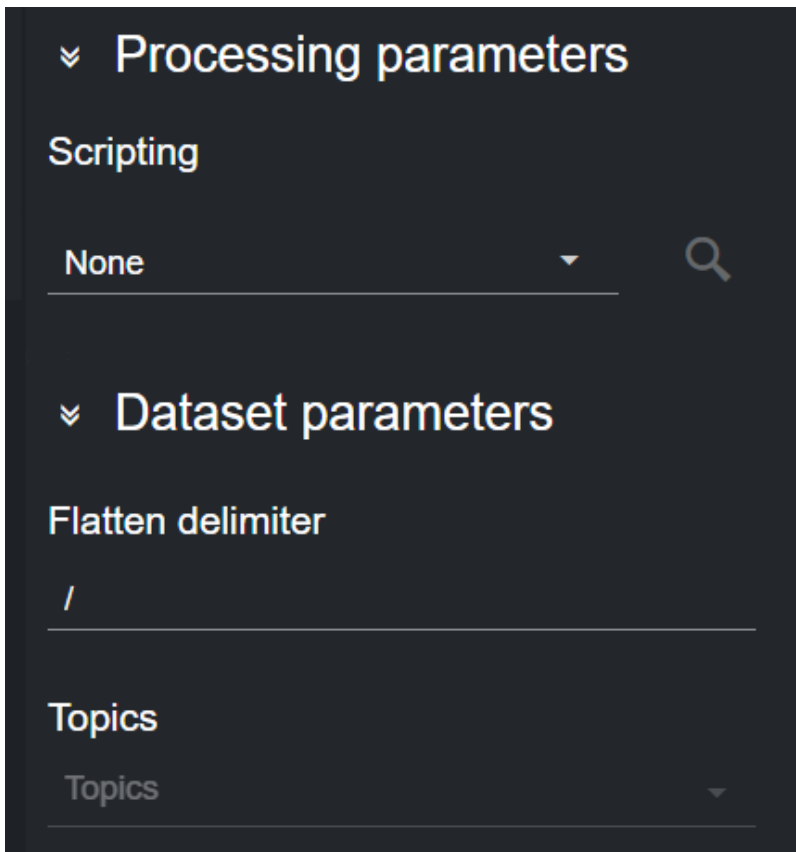

Select one or more topics from this list. The data published on these topics are added to the Dataset Entries table.



**Info:** Datacenter expects from the Kafka broker messages to contain valid JSON as payload. All other formats are discarded and the dataset state is set to Warning.

**Note:** Data from a Kafka data provider is typically event based. Therefore, if your broker publishes updating data (values of the same key that change over time), the data that is pushed to Datacenter updates the graphics instantly.

Please refer to the [Filtering and Manipulating a Dataset Entries](#) page to learn how to enable, disable and edit the entries added.

## Socket Listener

Datacenter supports datasets of type **Socket Listener**, allowing user to stream data into Datacenter via UDP or TCP. This provider effectively create a server that listens for incoming data.

This is particularly useful for scenarios when a user needs to stream frequently updating data to the Datacenter.

Follow these steps to configure a Socket dataset:

1. Create a new dataset of type **Socket Listener**, specifying a name and (optionally) a prefix to use to identify the dataset and its values:

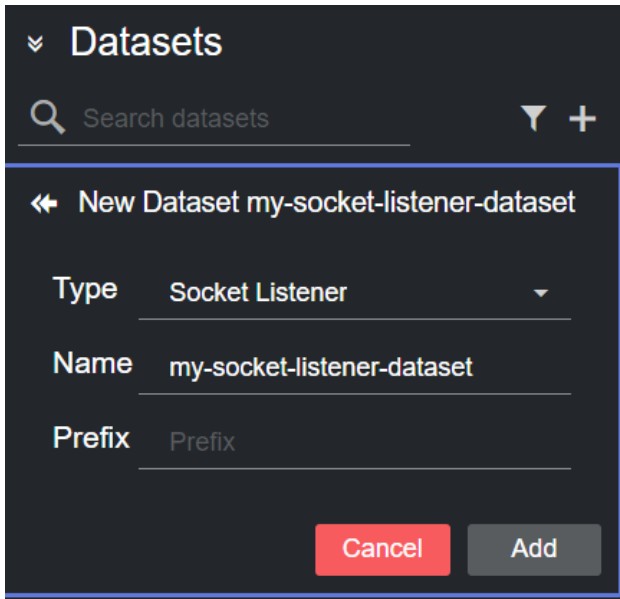

2. Click **Add**. The dataset is added to the list, and it has an initial *OK* status as its default protocol is UDP, for which is impossible to establish whether a connection to the socket has been made. However, in case another existing dataset is using the same default port (6000), then the newly added dataset is in an initial *ERROR* state.

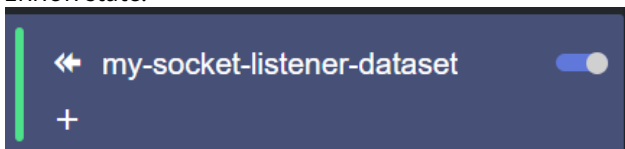

3. You can now configure the dataset in the **Dataset parameters** section panel by double clicking a row. Here you can specify a **Protocol** and a **Port** to start receiving data.

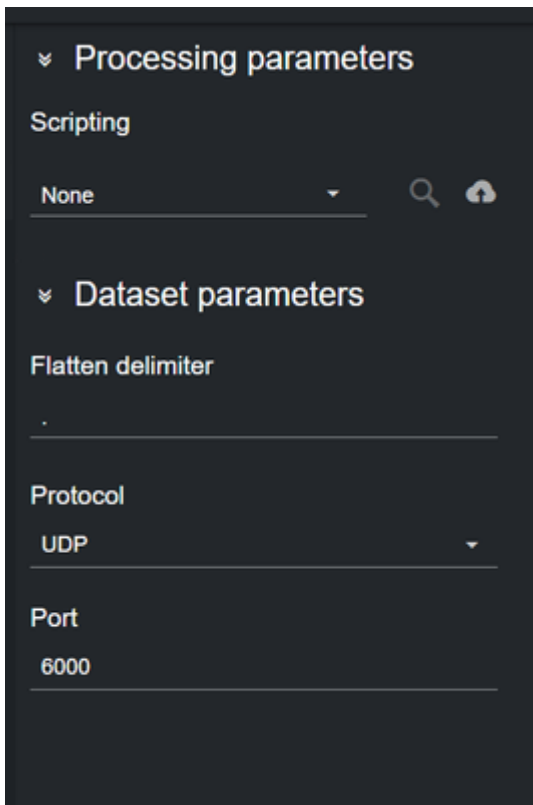

4. Depending on the protocol selected, the dataset can be in one of the following states:
  - a. **UDP**
    - i. *OK*: The specified port can be bound and (optionally) Datacenter receives data on it.
    - ii. *Error*: The specified port cannot be bound (already in use), a socket error happened or Datacenter is receiving malformed data.
  - b. **TCP**
    - i. *OK*: The specified port can be bound, a connection to it is established and (optionally) Datacenter receives data on it.
    - ii. *Warning*: Awaiting incoming connection.
    - iii. *Error*: A connection/socket error happened or Datacenter is receiving malformed data.
5. Given that the dataset is in an *OK* state, as soon as Datacenter receives data, the corresponding entries are added to the **Dataset Entries** table.

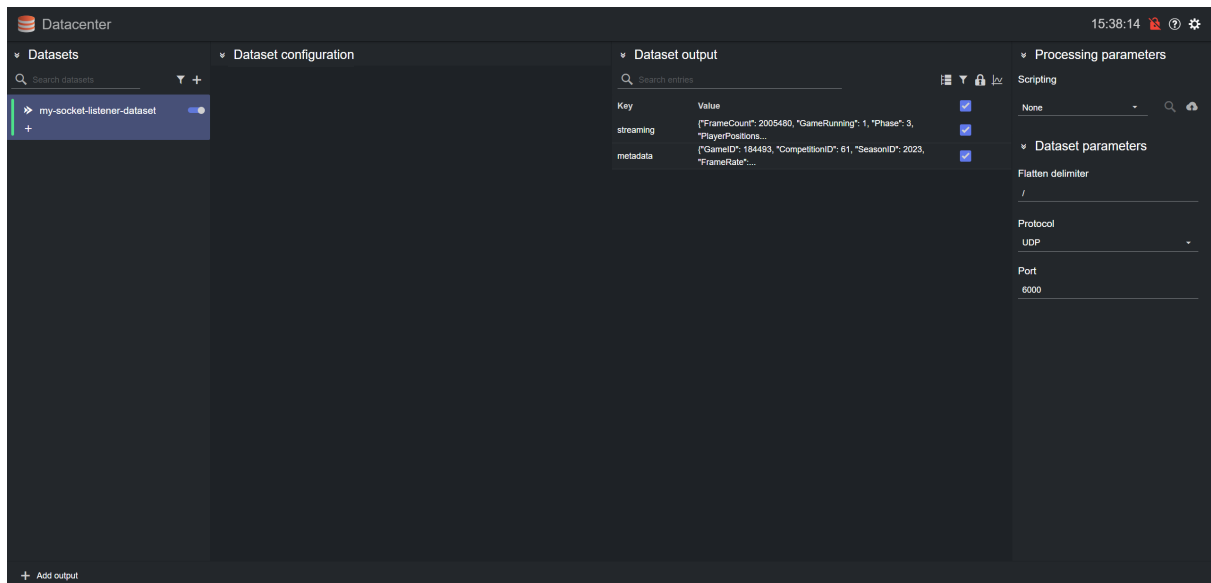

Please refer to the [Filtering and Manipulating a Dataset Entries](#) page to learn how to enable, disable and edit the entries added.

**Note:** a Socket Listener provider expects the data formatted as a valid **JSON**.

**Note:** a Socket Connector provider, when using the TCP protocol, expects the data payload to terminate with a **new line** (i.e., '\n') separator character.

## Socket Connector

Datacenter supports datasets of type **Socket Connector**, allowing user to initiating streaming data to Datacenter from a TCP streaming server. Unlike a Socket Listener dataset, a dataset of this provider connects to an existing TCP server to initiate the streaming.

This is particularly useful for scenarios when a user needs to receive frequently updating data.

Follow these steps to configure a Socket dataset:

1. Create a new dataset of type **Socket Connector**, specifying a name and (optionally) a prefix to use to identify the dataset and its values:

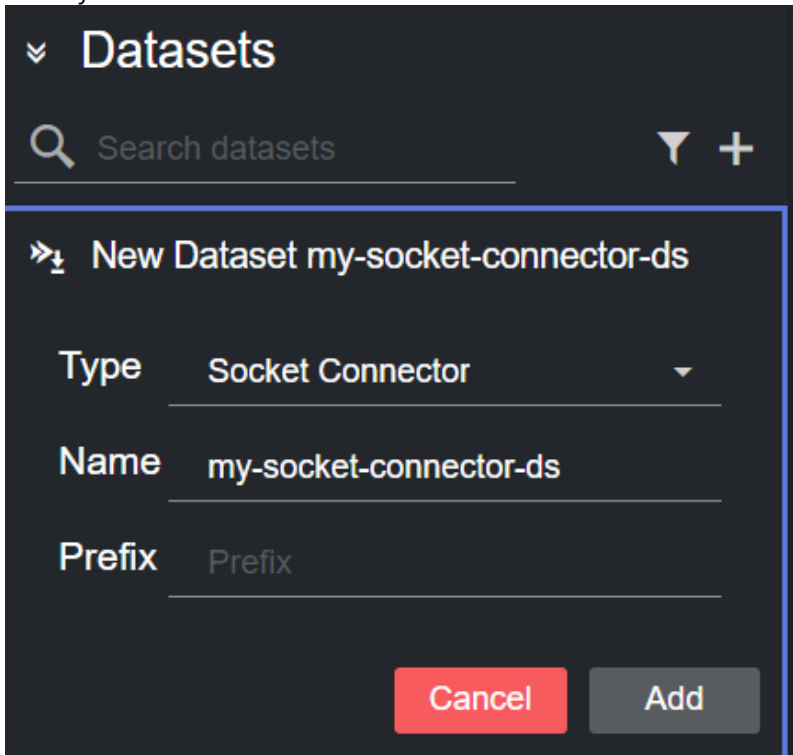

The screenshot shows a dark-themed dialog box titled "New Dataset my-socket-connector-ds". At the top, there is a search bar with the text "Search datasets" and a filter icon. Below the search bar, the dialog contains three input fields: "Type" with a dropdown menu showing "Socket Connector", "Name" with the text "my-socket-connector-ds", and "Prefix" with the text "Prefix". At the bottom of the dialog, there are two buttons: a red "Cancel" button and a grey "Add" button.

2. Click **Add**. The dataset is added to the list, and its status depends on whether the server it is connecting to is up and running.

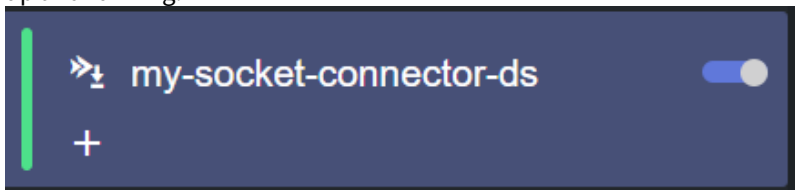

3. You can now configure the dataset in the **Dataset parameters** section panel by double clicking a row. Here you can specify a **IP** and a **Port** to start receiving data.

The screenshot shows a dark-themed configuration panel. At the top, there is a section titled 'Processing parameters' with a downward arrow icon. Below this, the 'Scripting' section is visible, with a dropdown menu currently set to 'None' and a search icon to its right. The next section is 'Dataset parameters', also with a downward arrow icon. Under 'Dataset parameters', there are three input fields: 'Flatten delimiter' with a slash '/' as the value, 'IP' with '127.0.0.1' as the value, and 'Port' with '5009' as the value.

4. Depending on the state of the connecting sever, the dataset can be in one of the following states:
  - a. *OK*: a connection to it is established and (optionally) Datacenter receives data on it.
  - b. *Warning*: Awaiting connection.
  - c. *Error*: A connection error happened or Datacenter is receiving malformed data.
5. Given that the dataset is in an *OK* state, as soon as Datacenter receives data, the corresponding entries are added to the **Dataset Entries** table.

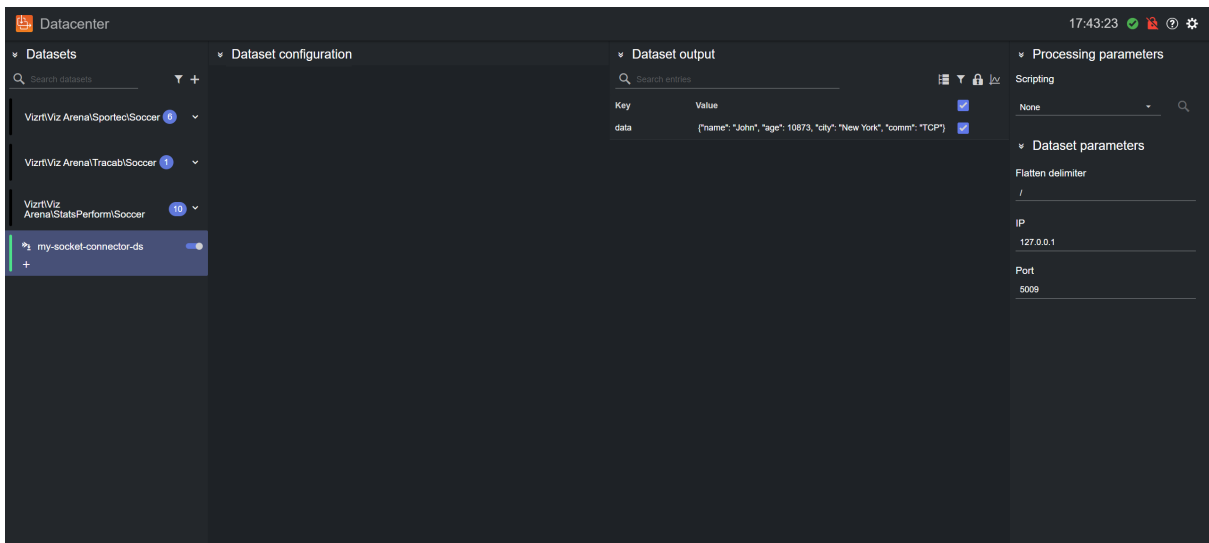

Please refer to the [Filtering and Manipulating a Dataset Entries](#) page to learn how to enable, disable and edit the entries added.

**Note:** a Socket Connector provider expects the data formatted as a valid **JSON**.

**Note:** a Socket Connector provider expects the data payload to terminate with a **new line** (i.e., '\n') separator character.

## Tracab

Datacenter supports datasets of type **Tracab**, allowing you to stream data into Datacenter from [Tracab](#) data streams.

Follow these steps to configure a Tracab dataset:

1. Create a new dataset of type **Socket Listener**, specifying a name and (optionally) a prefix to use to identify the dataset and its values:

2. Click **Add**. The dataset is added to the list, and it has an initial *ERROR* status as its default values are to not allow for a successful authentication.

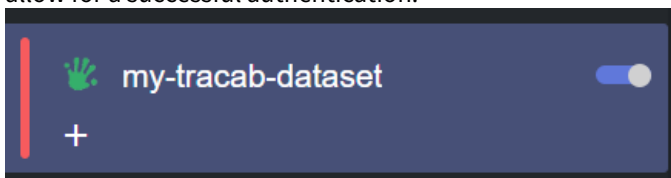

3. You can configure the dataset in the **Dataset parameters** section panel by double clicking a row.

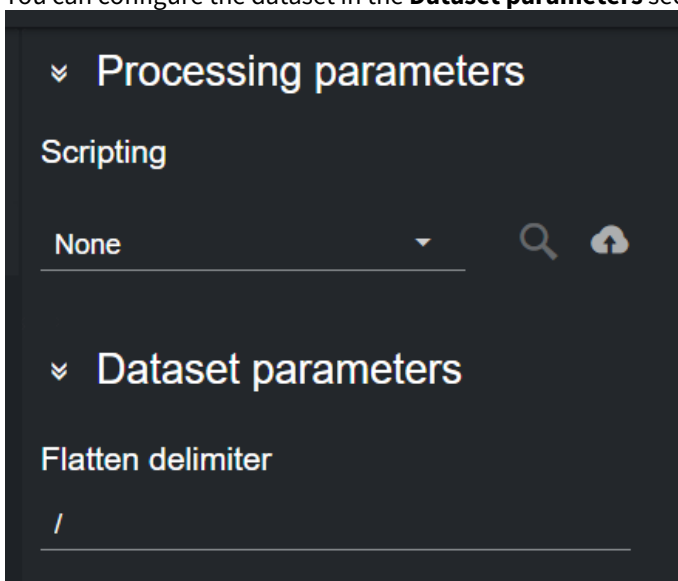



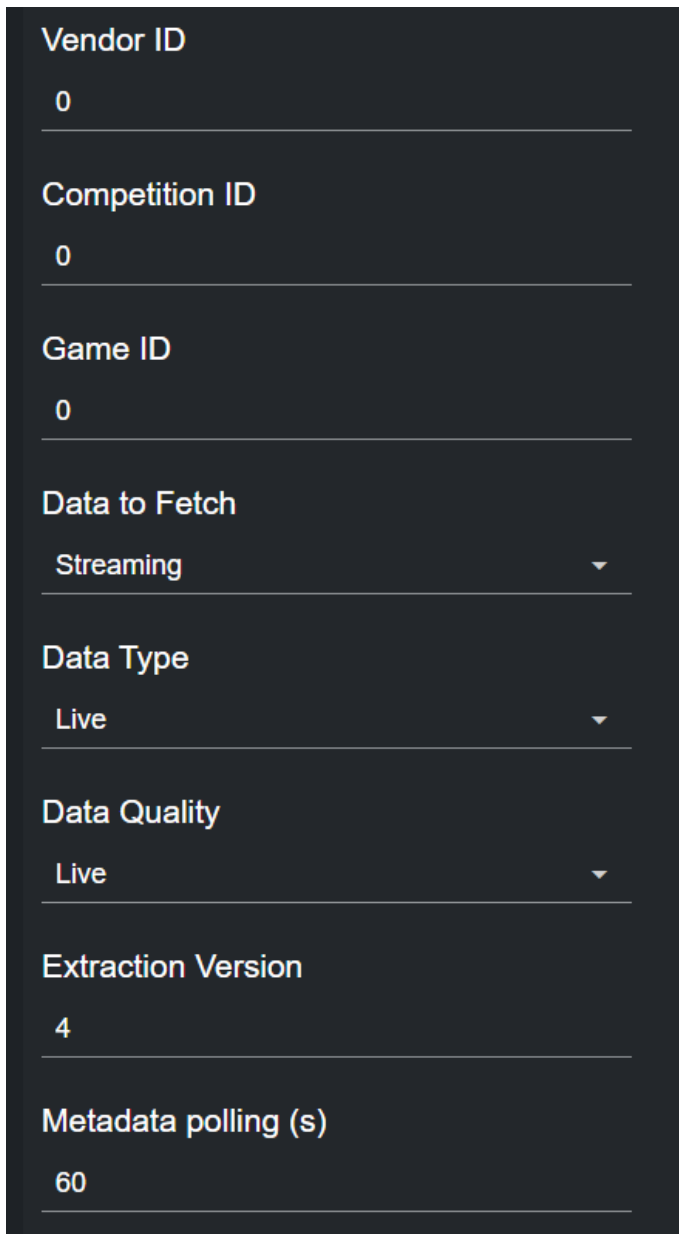

Vendor ID  
0

Competition ID  
0

Game ID  
0

Data to Fetch  
Streaming

Data Type  
Live

Data Quality  
Live

Extraction Version  
4

Metadata polling (s)  
60

4. Values provided by Tracab that need to be adjusted per game:
  - a. **Vendor ID:** ID of the vendor provided by Tracab.
  - b. **Competition ID:** ID of the competition provided by Tracab.
  - c. **Game ID:** ID of the game provided by Tracab.
5. These values can be used to configure the type of data to get:
  - a. **Data to Fetch:** Selected whether to fetch streaming data only, metadata only, or both.

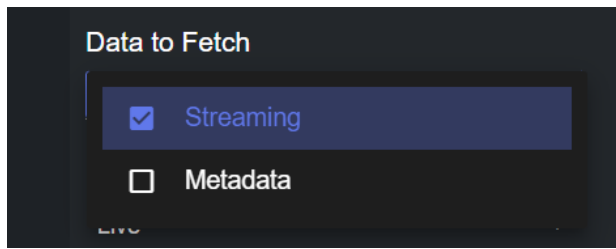

- b. **Data Type:** Fetches Live or Delayed data type, provided by Tracab.

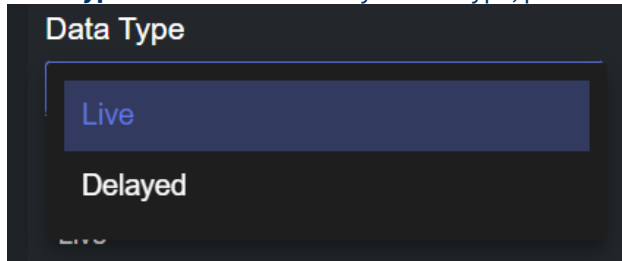

- c. **Data Quality:** Fetches Live, Scrubbed or Secondary Live data quality, provided by Tracab.

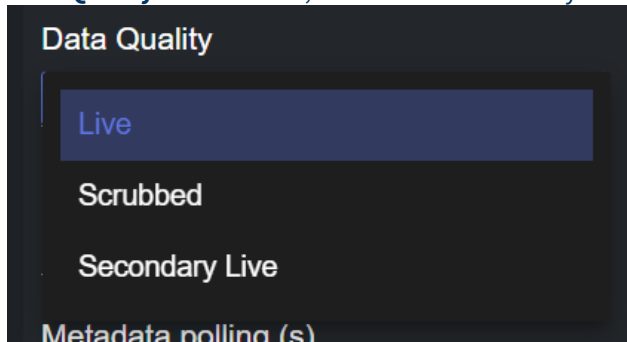

- d. **Extraction Version:** Version of the data to use provided by Tracab. Default to 4.
  - e. **Metadata polling (s):** How often the metadata should be polled from the Tracab Statistical API backend. This value has only effect if **Data to Fetch** includes **Metadata**.
6. Depending on the settings, the dataset can be in one of the following states:
    - a. *OK*: The settings are correct and the Tracab authentication was performed correctly. A stream is opened and Datacenter receives data (if any is sent). If specified, metadata is polled from the Statistical REST Api.
    - b. *Error*: The settings are incorrect (either in the **Dataset parameters** or in the [Provider Configuration](#)). Hover on the dataset name to reveal the error.
  7. Given that the dataset is in an *OK* state, as soon as Datacenter receives data, the corresponding entries are added to the **Dataset Entries** table.

Please refer to the [Filtering and Manipulating a Dataset Entries](#) page to learn how to enable, disable and edit the entries added.

## 5.4.2 Filtering and Manipulating a Dataset Entries

The data contained in each dataset can be filtered or modified with tools provided by Datacenter. This way, a user can control in real-time, which values are sent to the output(s) and in which format.

Data manipulation can be done by [filtering](#), [scripting](#) and [flattening](#). Each step acts on the dataflow, whether it is globally (filtering) or locally (scripting and flattening), and is applied in a specific order, as shown in the diagram below:

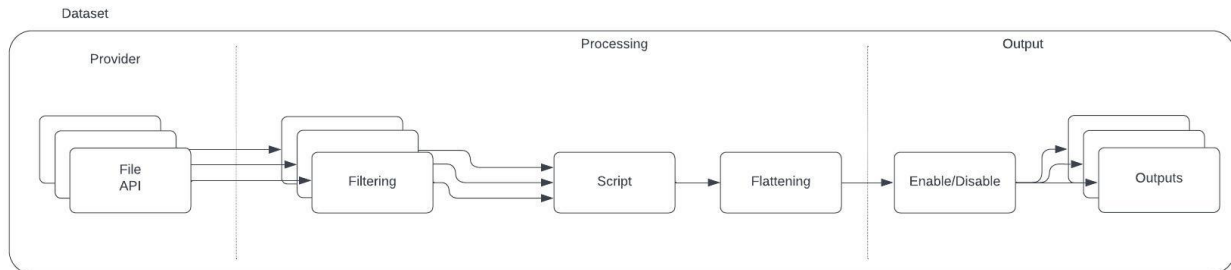

This section describes how to filter and manipulate dataset entries in Datacenter, including:

- [Filtering a Dataset](#)
- [Manipulating Dataset Entries via Scripting](#)
- [Flattening a Dataset](#)

## Filtering a Dataset

### Introduction

Filtering can be used to process the incoming data before it is sent to the outputs, allowing flexible data manipulation.

These are the following topics:

- [Introduction](#)
- [Accessing the Filter Page](#)
- [Interacting with the Tree: Filtering Nodes](#)
- [Searching Nodes and Inspecting Sample Values](#)

Unlike other data manipulation operations ([scripting](#) and [flattening](#)), filtering acts on the data schema rather than the payload. That is, filtering acts on an object representation rather than on its instance.

**Info:** When filtering a dataset, the incoming data must be a valid JSON object. When this is not the case, filtering cannot be applied to a dataset.

For example, given the incoming data below:

### Incoming Object

```
[
  {
    "id": "457e14f6-6244-4fb5-882a-eafc874ac384",
    "label": "Soccer",
    "UUID": "457e14f6-6244-4fb5-882a-eafc874ac384"
  },
  {
    "id": "1f66f5cf-978e-4fc1-9c39-7f2bde73778c",
    "label": "Basketball",
    "UUID": "1f66f5cf-978e-4fc1-9c39-7f2bde73778c"
  },
  {
    "id": "fb238641-7e4b-4578-b34f-bdd172be03bf",
    "label": "Tennis",
    "UUID": "fb238641-7e4b-4578-b34f-bdd172be03bf"
  }
]
```

Filtering it to remove "id" and "UUID" results in the data held in the datacenter to be:















### Incoming Object

```
[
```

```
[
  {
    "label": "Soccer"
  },
  {
    "label": "Basketball"
  },
  {
    "label": "Tennis"
  }
]
```

On subsequent data, should the array contain more entries and assuming the same filtering is applied, then the Datacenter only reads the property "label" for all entries.

Currently, the following providers support filtering:

Provider	Filtering Supported
Manual Dataset	
File Dataset	
Replicator Dataset	
Sportzcast Dataset	
Tricaster Vectar	
Kafka Dataset	
Rest Webserver Dataset	
Fluid Data Services Dataset	
Stats Perform	
Viz Data Connectors	
Socket Listener	
Socket Connector	
Tracab	
Sportec Solutions	

### Accessing the Filter Page

To access the filtering page, select a dataset of one of the supported providers, hover on an instance of a template and in the hamburger menu that appears, select **Filter**:

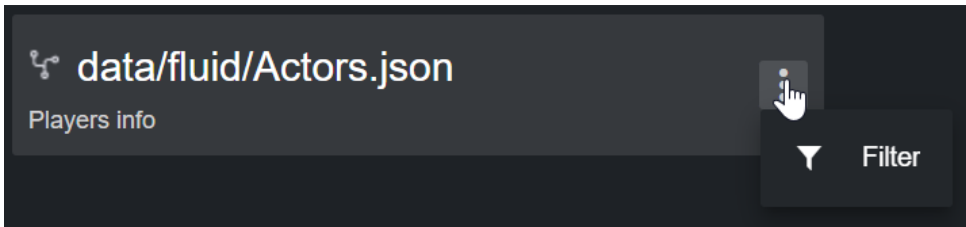

This opens a dialog, where the "schema" (an abstract representation that describes your existing data format) is shown as an interactive tree.

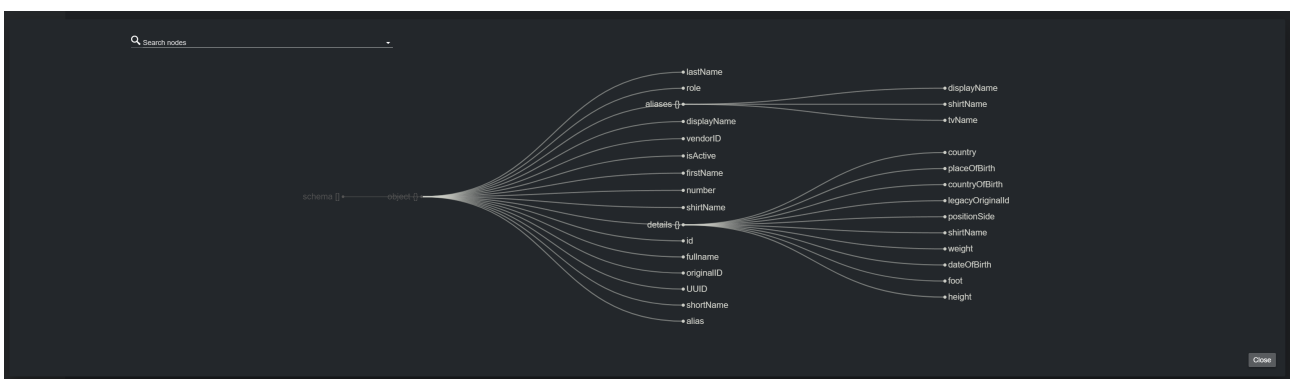

### Interacting with the Tree: Filtering Nodes

The tree shown in the filtering dialog can be panned and zoomed: use your mouse's left-button to pan, and the mouse scroll wheel to zoom.

A node in the tree can be in one of the following three states:

State	
Active (filtered in)	
Inactive (filtered out)	
Disabled	

- **Active:** The node is added to the dataset data. If a node represents an object, its children are also added if no further filtering is applied, or the individual filtering on the children is considered.

- **Inactive:** The node is not added to the dataset data. If a node represents an object, all its children is excluded from the dataset.
- **Disabled:** No interaction is possible with the node.

When adding a new data source, by default, the incoming data is set to active. That is, all fields in the incoming object are added to the dataset data. To start filtering nodes in the tree, click on the nodes you wish to add to the dataset.

When clicking on a node, there are three possible scenarios:

1. A **leaf node that is directly connected to the root** is clicked: a single node is added to the dataset.

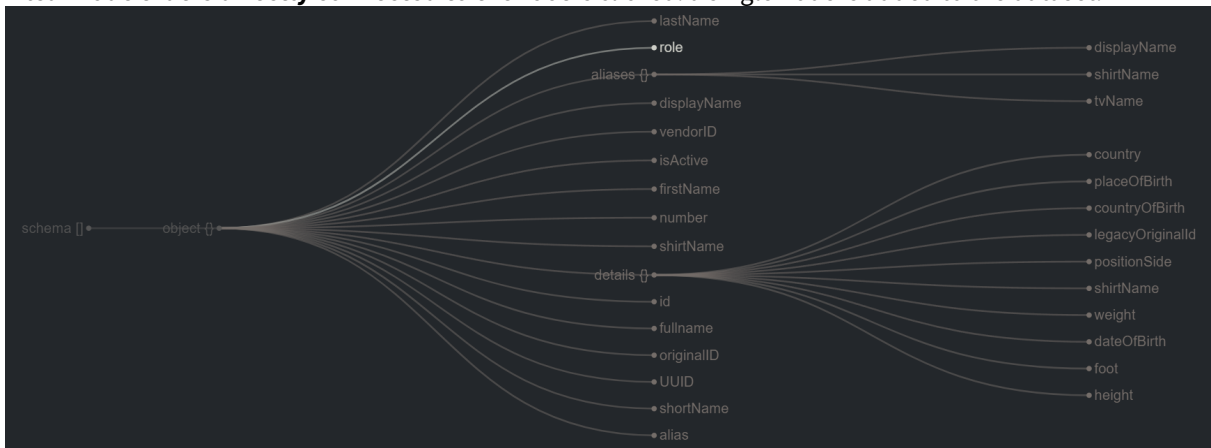

2. A **leaf node that is a children of an object** is clicked: the leaf node, its parents, and all other parents up to the root are added to the dataset.

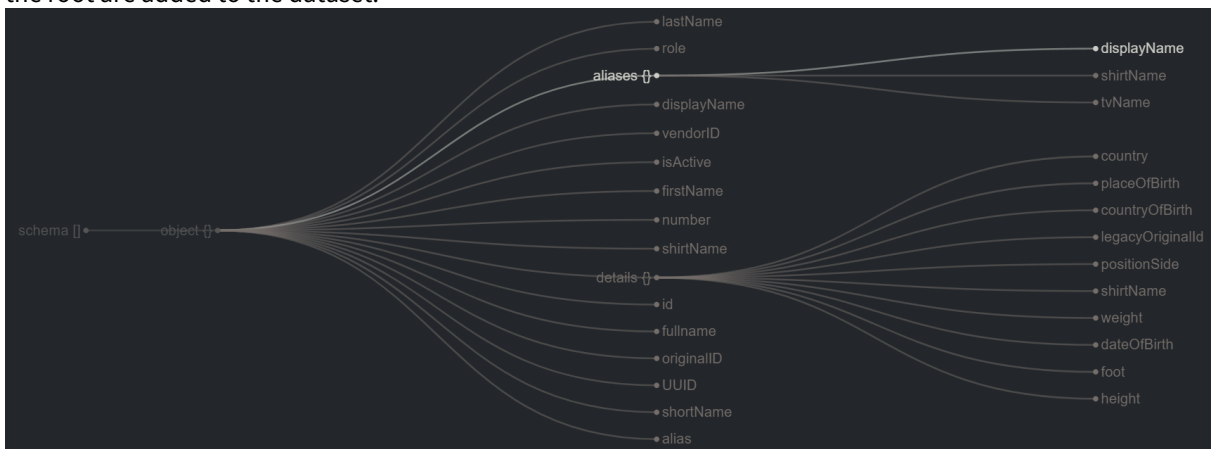

3. A **node representing an object** is clicked: the object node, its children, and its parents and all other parents up to the root are added to the dataset.

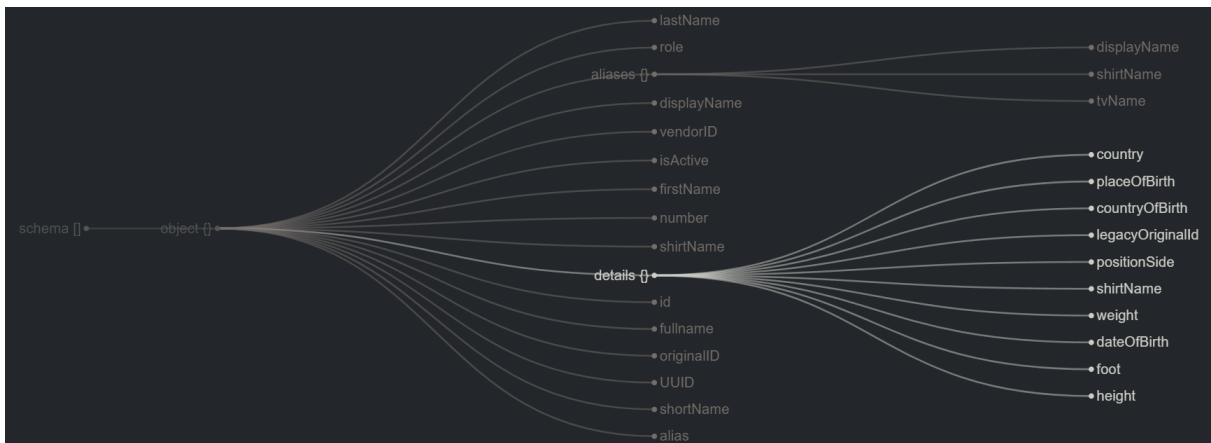

Once you start filtering a dataset, you can click on a node to toggle its state. That is, clicking on a node for the first time sets its state to active. Clicking on it again sets its state to inactive.

To further illustrate how filtering works, consider the following filtered tree:

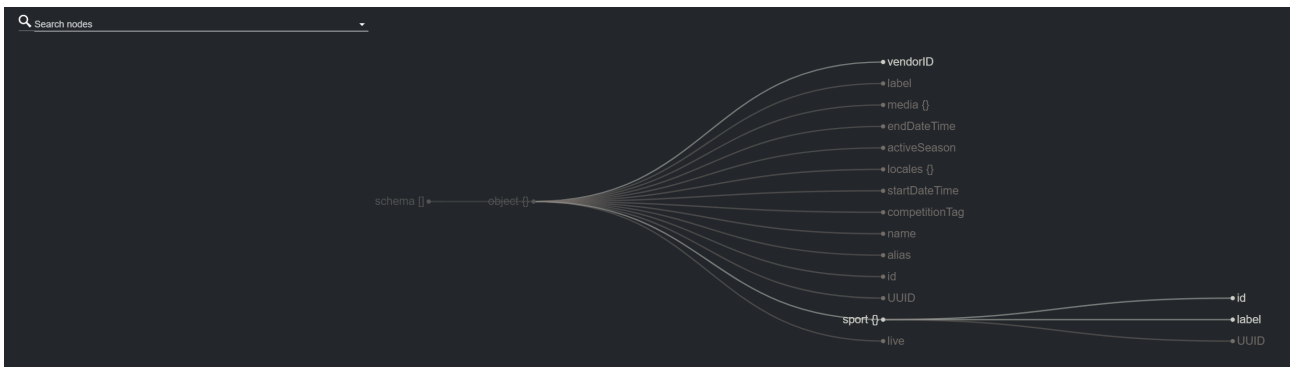

This selection results in the dataset to hold the following (flattened) values.

Dataset output		
Search entries		
Key	Value	
0/sport/label	soccer	<input checked="" type="checkbox"/>
0/sport/id	457e14f6-6244-4fb5-882a-eafc874ac384	<input checked="" type="checkbox"/>
0/vendorID	Opta	<input checked="" type="checkbox"/>

### Searching Nodes and Inspecting Sample Values

Nodes in the tree can be searched using the **Search nodes** field in the top-left of the dialog. Start typing a node name in the text field to see all possible matches. By selecting one of the results, the corresponding node briefly changes color and size.



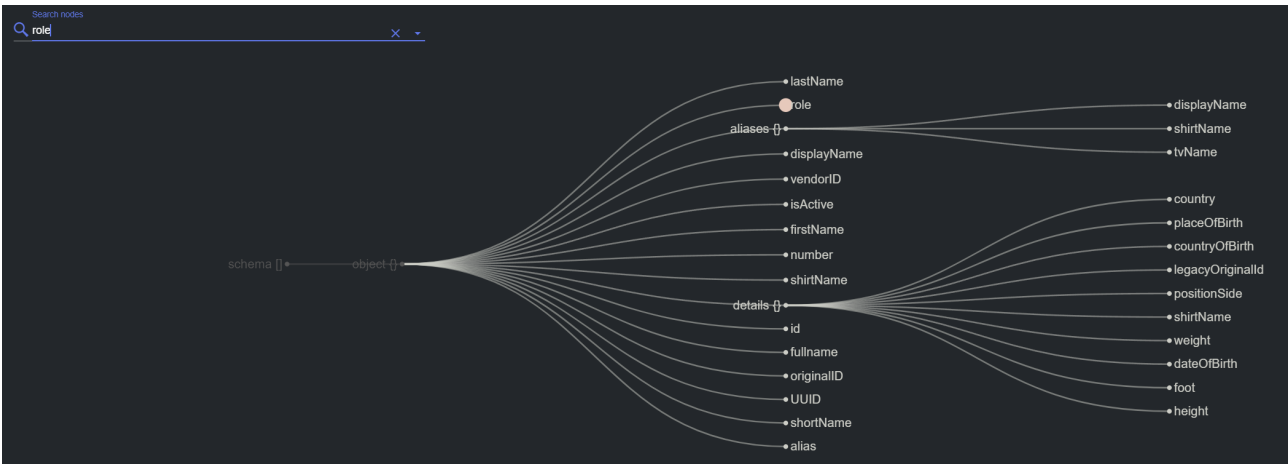

**Note:** Searching a node triggers highlighted animations on the tree and has no effect on the final dataset. That is, selecting a node name from the search text field does not add the node to the dataset output.

To get an idea of the incoming data, sample payload can be inspected for each node in the tree. To reveal the sample content of a node, hover on its name.

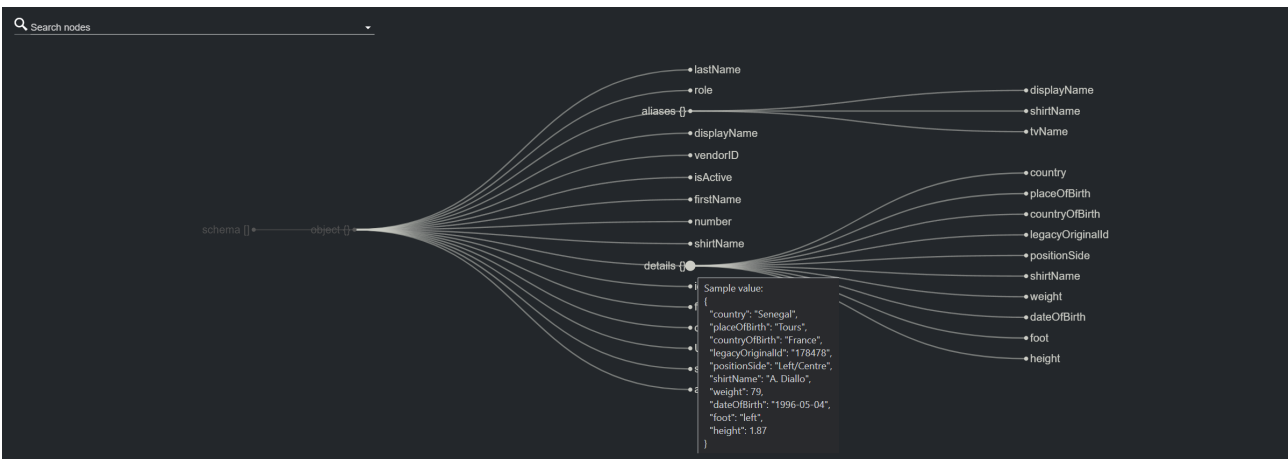

## Manipulating Dataset Entries via Scripting

### Introduction

Scripting can be used to process the incoming data before it is sent to the output, allowing flexible data manipulation. For example, data can be normalized to an expected format / units, and new entries can be computed from incoming data.

These are the following topics:

- [Introduction](#)
- [Applying a Script](#)
- [Development](#)
- [Process](#)
- [Arguments](#)
- [Imports](#)
- [Caching Data](#)
- [Debugging](#)

### Applying a Script

Scripts can be applied to a dataset via the **Processing parameters** panel:

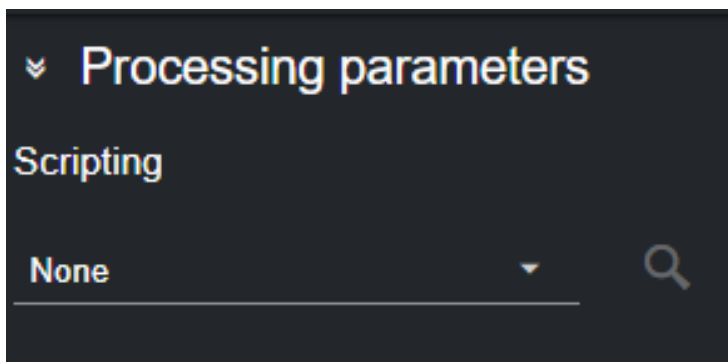

- To apply a script, open the corresponding dropdown menu and select the script to apply.

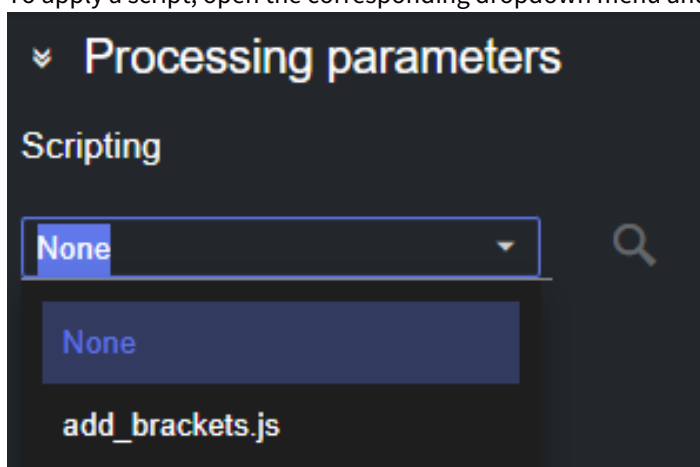

- Scripts are applied immediately on the dataset output. When applied successfully, the icon next to the script name turns green.



- Conversely, scripts that are not applied successfully show a red icon next their name. You can hover over the icon to reveal the error message.

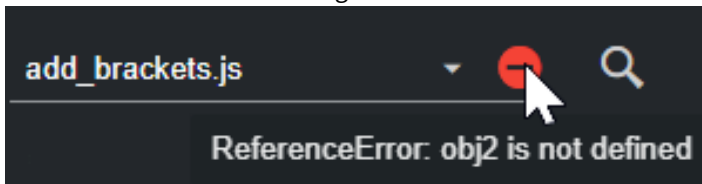

- By clicking the magnifier glass icon  you can inspect the content of the loaded script.

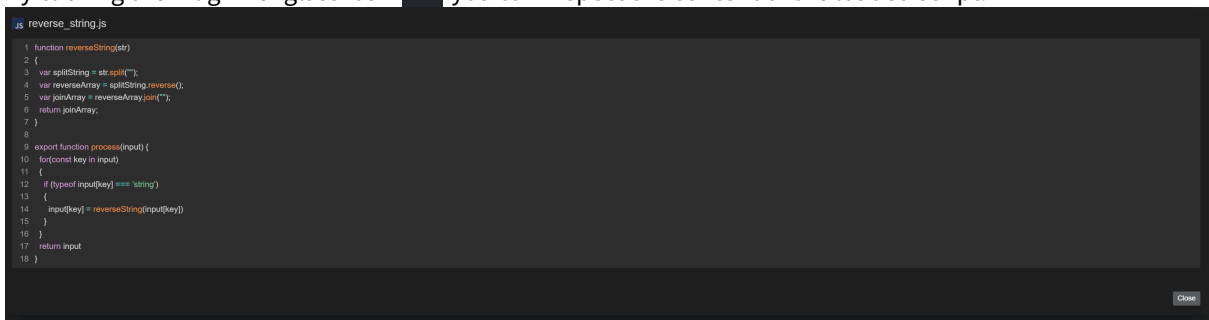

- In case of errors, information about the error(s) type and location is displayed below the code section.



### Adding A New Script

Datacenter, constantly monitors all the scripts located in `C:\ProgramData\vizrt\Datacenter\scripts`, and therefore, the new scripts added to that folder are immediately visible in the Datacenter script list.

Another option to add a new script is to enable the **Allow uploading scripts** toggle in the General/Communication section of the Admin page.

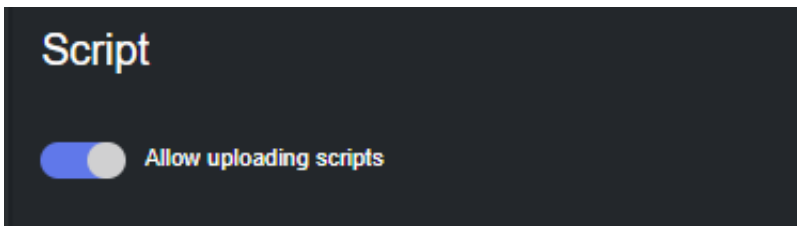

Doing so, enables an upload button next to the scripts list in the main page, which can be used to load new scripts.

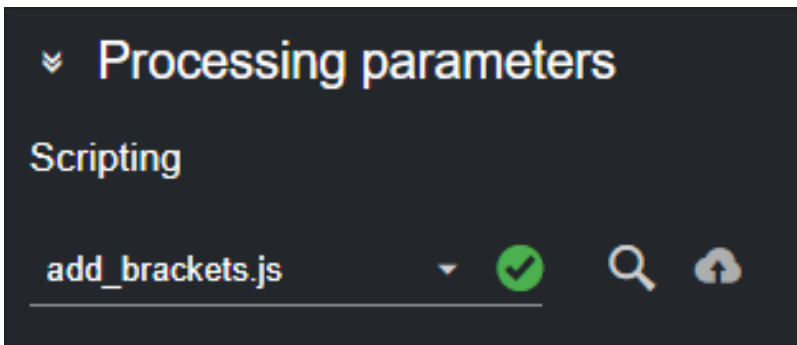

**Warning:** Datacenter does not vet uploaded scripts, therefore, allowing the upload of arbitrary scripts to Datacenter can pose a security threat. We **strongly recommend** to enable scripts uploading, only when strictly necessary and for the time required.

## Development

Scripts are Javascript programs located in `C:\ProgramData\vizrt\Datacenter\scripts`, and they must be named as `*.js` (sub-directories are supported).

Scripts are constantly monitored by Datacenter, and are reloaded every time there is a change.

To start developing a script, simply open a Visual Studio Code (or any other text editor) in `C:\ProgramData\vizrt\Datacenter\scripts`, create a script and see your changes applied as soon as the file is saved.

**Warning:** Because of the file watcher, when saving a script with VS Code, the file might suddenly become empty. Therefore, simply Undo (**CTRL + Z**) the last action and save the file again.

## Process

All scripts must export a function named `process`, which is then called whenever data is received from a provider.

When multiple inputs are configured (for example multiple endpoints for a REST provider), the input variable holds the incoming data in multiple members named `data`, `data_1`, `data_2`.

## Example

Here is an example of a script with the following inputs:

### Input

```
raw_endpoint_data_1 = { // in the script, this is readable from input.data
```

```

    "key11": 1,
    "key12": 2
  }

  raw_endpoint_data_2 = { // in the script, this is readable from input.data_1
    "key21": 3,
    "key22": 4
  }

```

### Script

```

export function process(input) {
  var obj1 = JSON.parse(input.data);
  var obj2 = JSON.parse(input.data_1);
  return {
    a: obj1.key11,
    b: obj2.key21,
    c: obj1.key12 + obj2.key22
  }
}

```

The output data is then three keys (a, 1), (b, 3) and (c, 6).

### Arguments

To allow more flexible scripts, arguments can be added to the code and are shown in the UI.

It is possible to add numbers, strings, enums and date arguments that are then passed to the script during execution.

A function named *getProcessArguments* must be exported from the script and must return the arguments created with helper functions (see example). This function takes an optional parameter of the current provider input, allowing to create arguments dependent on the currently received values.

#### Argument Declaration Helper Functions

The following helpers can be used to declare scripts arguments:

```

function argumentEnum(name, defaultIndex, values, description="") { /*... */ }
function argumentString(name, defaultValue, description="") { /*... */ }
function argumentInt(name, defaultValue, min = Number.MIN_VALUE, max =
Number.MAX_VALUE, description="") { /*... */ }
function argumentFloat(name, defaultValue, min = Number.MIN_VALUE, max =
Number.MAX_VALUE, description="") { /*... */ }
function argumentDate(name, defaultValue, description="") { /*... */ }
function argumentIntegerRange(name, min = Number.MIN_VALUE, max = Number.MAX_VALUE,
stepSize, description = "") { /*... */ }

```

The enum values can be of type *string*, or an object of type *{label: string, data: string}*. On the second case, the label is displayed to the user and the script receives the data.

## Example

## Example with hard-coded arguments

```

export function getProcessArguments() {
  return [
    argumentEnum("enumArg", 0, ["option1", "option2"], "An enum argument"),
    argumentEnum("enumWithValuesArg", 1, [ {"label": "option3", "data": "value3"}
, {"label": "option4", "data": "value4"}], "Another enum argument"),
    argumentString("stringArg", "default value", "A string argument"),
    argumentInt("intArg", 2, 0, 5, "An int argument"),
    argumentFloat("floatArg", 3.1, 1.2, 5.6, "A float argument"),
    argumentDate("dateArg", "2023-07-01", "A date argument"),
    argumentIntegerRange("integerRangeArg", 0,90,1, "A range argument"),
  ];
}

export function process(input, args) {
  var result = {}
  result["receivedInput"] = input.data;
  result["receivedEnumArg"] = args.enumArg;
  result["receivedEnumWithValuesArg"] = args.enumWithValuesArg;
  result["receivedStringArg"] = args.stringArg;
  result["receivedIntArg"] = args.intArg;
  result["receivedFloatArg"] = args.floatArg;
  result["receivedDateArg"] = args.dateArg;
  result["receivedIntegerRangeArg"] = args.integerRangeArg;

  return result;
}

```

## Example with arguments generated from input

```

/** Function called by the Viz Datacenter scripting stage. The script's input
arguments are defined with this function.
 * @param {object} input The input object
 * @returns {object[]} An Array of arguments
 */
export function getProcessArguments (input) {
  const events = getEvents(input)
  const options = getEventOptions(events)

  return [argumentEnum('Event', 0, options, 'The event to select')]
}

/** Retrieves the list of events from the input object
 * @param {object} input The input object
 * @returns {object[]} A list of all the events
 */

```

```
function getEvents (input) {
  let events = []
  if (input.data) {
    const obj = parseInputObject(input)
    for (const event of obj.liveData.event) {
      events.push(event)
    }
  }
  return events
}
```

Assuming some kind of input and if the user does not modify the default arguments, the dataset would contain the following values:

receivedInput	{ "inputData": "something" }
receivedEnumArg	option1
receivedEnumWithValuesArg	value4
receivedStringArg	<b>default</b> value
receivedIntArg	2
receivedFloatArg	3.1
receivedDateArg	2023-07-01

## Imports

In order to allow code reuse, it is possible for a script to import another file. Those imported files must be named *\*.import.js*, so they are not shown as scripts in the Datacenter UI.

The imports are relative to the scripts root directory *C:\ProgramData\vizrt\Datacenter\scripts*, not the current script directory.

### Example

#### utils/helpers.import.js

```
export function doNothing(input) {
  return input;
}
```

#### provider/script.js

```
import { doNothing } from "utils/helpers.import.js"

export function process(input) {
  return doNothing(input);
}
```

## Caching Data

The Scripting module allows to cache data across executions. This is particularly useful when handling time-series, or when statistics across several executions need to be computed. Similarly, the value from one time slice can be saved and fetched at later stages. The cache can be directly accessed from within scripts and it is allocated per-script (two scripts cannot access the same cache values).

As the cache is implemented as an unordered map, you can **update** a value by writing in the same key on each run, or can **store** the value of an item in *different runs* by using a time-increasing key.

The following utility functions can be used to manipulate the cache:

- `Cache.Read()`
  - read the current cache. Return a dictionary `Dictionary<string, object>`.
- `Cache.Remove(key: string)`
  - removes the entry with key 'key' from the cache.
- `Cache.Write(newCache: Dictionary<string, object>)`
  - swaps the current cache with 'newCache'.
- `Cache.Keys()`
  - get all cache keys, as an `Array<string>`

### Example

#### `utils/helpers.import.js`

```
function getCachedData(key: string)
{
  const cachedData = Cache.Read(key);
  return cachedData !== null ? cachedData : undefined;
}

function writeCachedData(key: string, value: string)
{
  let cache = Cache.Read();
  cache [key] = value;
  Cache.Write(cache);
}

function cleanCache()
{
  var cacheKeys = Cache.Keys();
  for(let i=0; i<cacheKeys.length; ++i)
  {
    let key = cacheKeys[i];
    Cache.Remove(cacheKeys[i]);
  }
}

export function manipulateCache() {
  const key = "my_key";
```



```

const data = 10;
writeCachedData(key, data);
const cached_data = getCachedData(key);
console.log(cached_data); // 10
cleanCache();
const cached_data2 = getCachedData(key);
console.log(cached_data2); // undefined
}

```

## Debugging

To debug a script add the following launch configuration to VS Code:

### Launch Configuration

```

{
  "launch": {
    "configurations": [
      {
        "name": "ClearScript",
        "type": "node",
        "request": "attach",
        "address": "localhost",
        "port": 9757
      }
    ],
    "compounds": []
  }
}

```

Then add the following line to the script to debug:

```
//SCRIPT_DEBUG_PORT=9757
```

In VS code, execute **Run and debug** with the ClearScript configuration. The debugger attaches to the running script and breakpoints can be set in the **Loaded scripts** section.

**Info:** Because of some internal limitations, the debug port is not immediately freed after modifying a script. Therefore, it is necessary to adapt the debug port in the script and launch configuration when modifying and saving the debugged script.

## Flattening a Dataset

By default, datasets connected to providers providing data in valid JSON format (for example, Fluid Data Services) hold the incoming payload using the key-value pair `[data_N][Data_as_JSON_object]`, where N is the index of the dataset source where the data originates from (for example, in Fluid Data Services, the index of the endpoint configured for the dataset).

In the following scenario, a Fluid Data Services dataset is configured to accept data from two endpoints (Sport and Competition), and subsequently the data is organized in two key-value pairs (data and data\_1), one per endpoint:

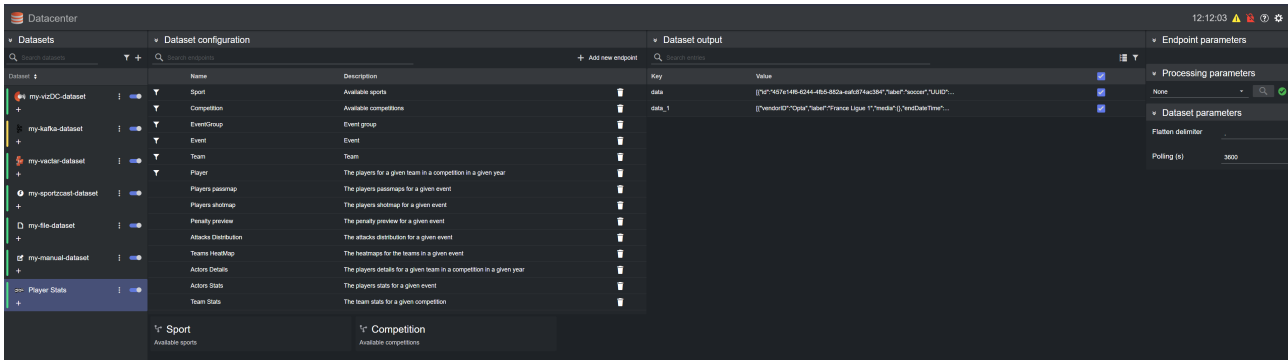

However, in certain scenarios, all values in the JSON objects need to be associated with a specific key. For these cases, one can automatically flatten the incoming data for a given dataset, by clicking on the flatten icon  in the top-right corner of the **Dataset output** panel. Doing so results in a flattened version of all the values of the incoming payload, where each atomic value in the JSON object(s) is associated to its own key:

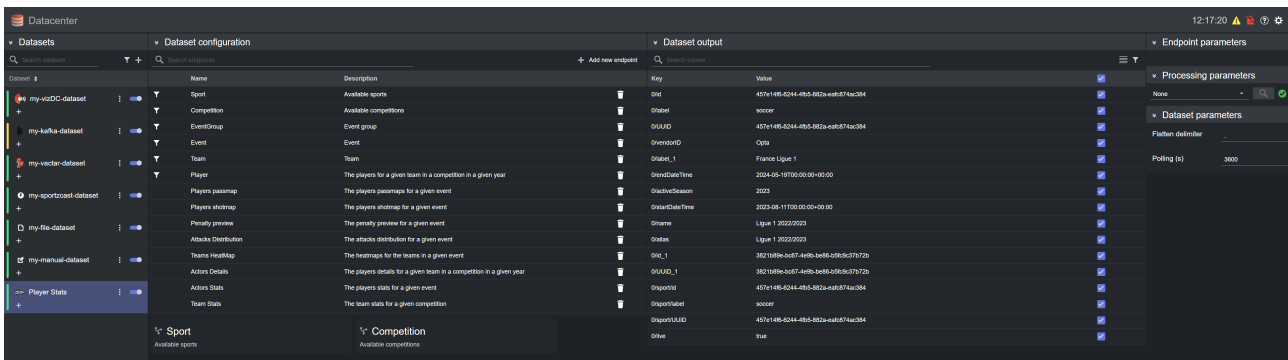

**Note:** When flattening several objects there is a chance of running into key duplication. Datacenter automatically detects such keys and appends a number to them, to make them unique again (for example, 0/label and 0/label\_1 in the image above).

**Note:** When flattening a payload that contains arrays, the index of the array element is prepended to the the element key, such that unique keys are created (for example, 0/id in the image above).

The default separator used to flatten the incoming data is specified in the [General configuration](#) in the Admin page. However, the delimiter can be changed per dataset, by using the **Flatten delimiter** field in the **Dataset parameters** section of the main view.

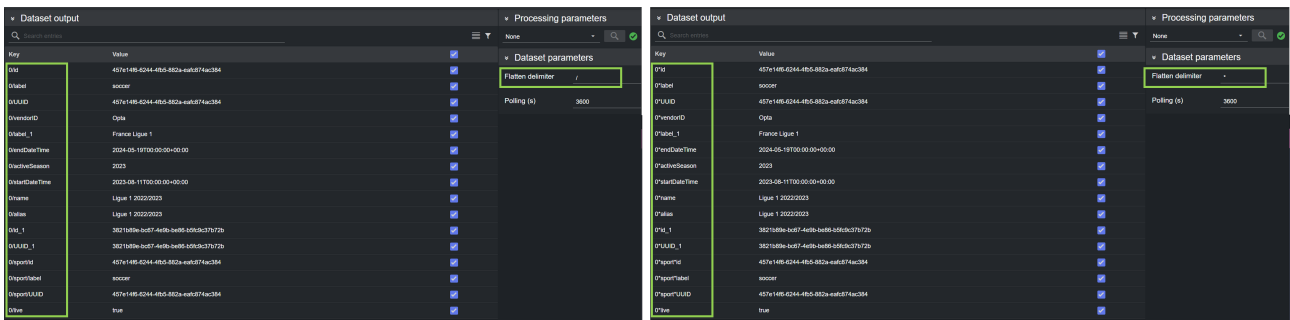

To unflatten the data back to the original [data\_N][Data\_as\_JSON\_object] format, click on the unflatten icon  in the top-right corner of the **Dataset output** panel.

**Note:** The flattening operation is only successful if the data to flatten is in JSON format. If you apply a script prior flattening, make sure the resulting script output is still a valid JSON objects for the flattening to have effect.

**Info:** For performance reasons, the number of flattened data elements that can be displayed is limited to 1024. This is also true for the search mechanism. All flattened keys are forwarded to the outputs, however.

### 5.4.3 Enabling or Disabling Dataset Entries

Once added, dataset entries are immediately enabled on all connected outputs. This results in all entries in the **Dataset output** to have a checked checkbox.

Dataset output		
Search entries		
Key	Value	<input checked="" type="checkbox"/>
0/live	false	<input checked="" type="checkbox"/>
0/sport/UUID	457e14f6-6244-4fb5-882a-eafc874ac384	<input checked="" type="checkbox"/>
0/sport/label	soccer	<input checked="" type="checkbox"/>
0/sport/id	457e14f6-6244-4fb5-882a-eafc874ac384	<input checked="" type="checkbox"/>
0/UUID	3821b89e-bc67-4e9b-be86-b5fc9c37b72b	<input checked="" type="checkbox"/>
0/id	3821b89e-bc67-4e9b-be86-b5fc9c37b72b	<input checked="" type="checkbox"/>
0/alias	Ligue 1 2020/2021	<input checked="" type="checkbox"/>
0/name	Ligue 1 2020/2021	<input checked="" type="checkbox"/>
0/competitionTag	3821b89e-bc67-4e9b-be86-b5fc9c37b72b	<input checked="" type="checkbox"/>
0/startDateTime	2022-08-05T00:00:00+00:00	<input checked="" type="checkbox"/>
0/activeSeason	2022	<input checked="" type="checkbox"/>
0/endDateTime	2023-06-04T00:00:00+00:00	<input checked="" type="checkbox"/>
0/label	France Ligue 1	<input checked="" type="checkbox"/>
0/vendorID	Opta	<input checked="" type="checkbox"/>

However, individual entries state can easily be toggled from the Datacenter UI. To disable a single entry, uncheck the checkbox in the relevant entry row in the **Dataset output** table.

Dataset output		
Key	Value	
O/live	false	<input type="checkbox"/>
O/sport/UUID	457e14f6-6244-4fb5-882a-eafc874ac384	<input type="checkbox"/>
O/sport/label	soccer	<input checked="" type="checkbox"/>
O/sport/id	457e14f6-6244-4fb5-882a-eafc874ac384	<input checked="" type="checkbox"/>
O/UUID	3821b89e-bc67-4e9b-be86-b5fc9c37b72b	<input checked="" type="checkbox"/>
O/id	3821b89e-bc67-4e9b-be86-b5fc9c37b72b	<input checked="" type="checkbox"/>
O/alias	Ligue 1 2020/2021	<input checked="" type="checkbox"/>
O/name	Ligue 1 2020/2021	<input checked="" type="checkbox"/>
O/competitionTag	3821b89e-bc67-4e9b-be86-b5fc9c37b72b	<input checked="" type="checkbox"/>
O/startDateTime	2022-08-05T00:00:00+00:00	<input checked="" type="checkbox"/>
O/activeSeason	2022	<input checked="" type="checkbox"/>
O/endDateTime	2023-06-04T00:00:00+00:00	<input checked="" type="checkbox"/>
O/label	France Ligue 1	<input checked="" type="checkbox"/>
O/vendorID	Opta	<input checked="" type="checkbox"/>

Likewise, all dataset entries can be disabled at once by clicking the checkbox in the header of the Dataset output table.

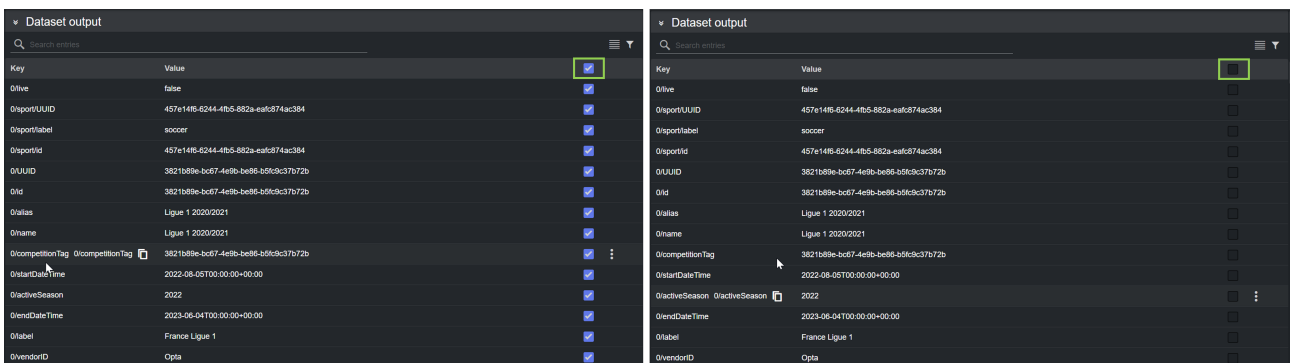

## 5.4.4 Inspecting Dataset Entries

### The Dataset Output Panel

The Dataset Output panel shows the received data for the selected dataset.

Dataset output

Search entries

Key	Value	
timecode	4036580	<input checked="" type="checkbox"/>
frame_nr	2018290	<input checked="" type="checkbox"/>
GlobalData.home.teamname	FC Bayern MÃ¼nchen	<input checked="" type="checkbox"/>
GlobalData.home.shortteamname	FC Bayern	<input checked="" type="checkbox"/>
GlobalData.home.color.primary	black	<input checked="" type="checkbox"/>
GlobalData.home.color.secondary	black	<input checked="" type="checkbox"/>
GlobalData.home.players	[{"jerseynumber":26,"firstname":"Sven","lastname":"Ulreich","startinp...	<input checked="" type="checkbox"/>
GlobalData.home.jerseynumbers	26,4,2,19,5,27,6,10,42,7,39,43,40,3,38,45,41,8,11,9	<input checked="" type="checkbox"/>
GlobalData.away.teamname	RB Leipzig	<input checked="" type="checkbox"/>
GlobalData.away.shortteamname	Leipzig	<input checked="" type="checkbox"/>
GlobalData.away.color.primary	black	<input checked="" type="checkbox"/>
GlobalData.away.color.secondary	black	<input checked="" type="checkbox"/>
GlobalData.away.players	[{"jerseynumber":21,"firstname":"Janis","lastname":"Blaswich","startin...	<input checked="" type="checkbox"/>
GlobalData.away.jerseynumbers	21,39,4,2,24,20,44,22,17,7,11,25,23,16,10,13,18,30,9,38	<input checked="" type="checkbox"/>
GlobalData.referee.color.primary	black	<input checked="" type="checkbox"/>
GlobalData.referee.color.secondary	black	<input checked="" type="checkbox"/>
GlobalData.referee.players	[{"jerseynumber":0,"firstname":"Bastian","lastname":"Dankert","startin...	<input checked="" type="checkbox"/>
GlobalData.game.running	true	<input checked="" type="checkbox"/>
GlobalData.game.phase	3	<input checked="" type="checkbox"/>
GlobalData.venue	?	<input checked="" type="checkbox"/>
GlobalData.city	?	<input checked="" type="checkbox"/>
GlobalData.scaleUnit	m	<input checked="" type="checkbox"/>
HOME.10.jerseynumber	10	<input checked="" type="checkbox"/>
HOME.10.team	HOME	<input checked="" type="checkbox"/>
HOME.10.onfield	1	<input checked="" type="checkbox"/>
HOME.10.firstname	Leroy	<input checked="" type="checkbox"/>
HOME.10.lastname	Sane	<input checked="" type="checkbox"/>
HOME.10.fullname	Leroy Sane	<input checked="" type="checkbox"/>
HOME.10.nametag	10 SANE	<input checked="" type="checkbox"/>
HOME.10.position.x	67.05	<input checked="" type="checkbox"/>
HOME.10.position.y	0	<input checked="" type="checkbox"/>
HOME.10.position.z	-23.79	<input checked="" type="checkbox"/>
HOME.10.normalizedposition.x	0.13857142857142857	<input checked="" type="checkbox"/>
HOME.10.normalizedposition.y	0.1501470588235294	<input checked="" type="checkbox"/>

### Inspecting Dataset Entries

- To inspect a dataset entry, hover over the entry on the right-most part of the corresponding row. On the menu revealed, press the **Show full value** option:

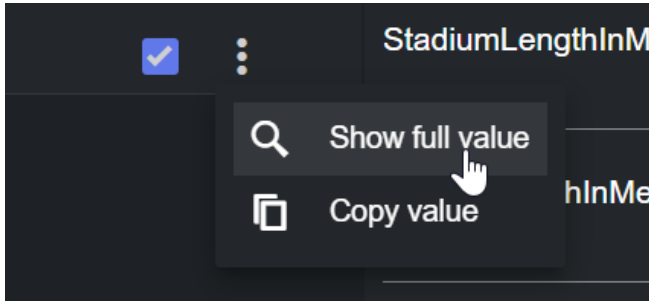

- A dialog is shown with the full entry.

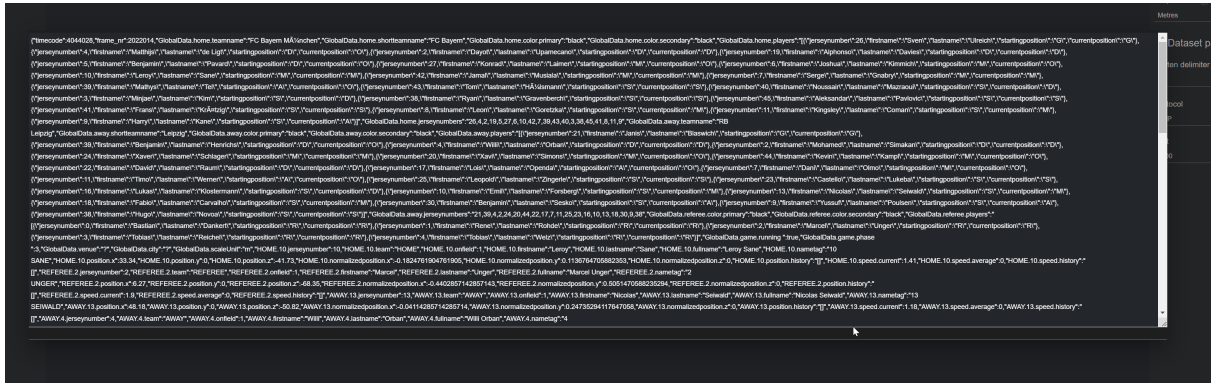

This feature is particularly useful for data entries that have long strings/JSON payloads as value.

### Copy Entries Key/Value

- To copy a dataset entry's value, hover over the entry on the right-most part of the corresponding row. On the menu revealed, press the **Copy Value** option:

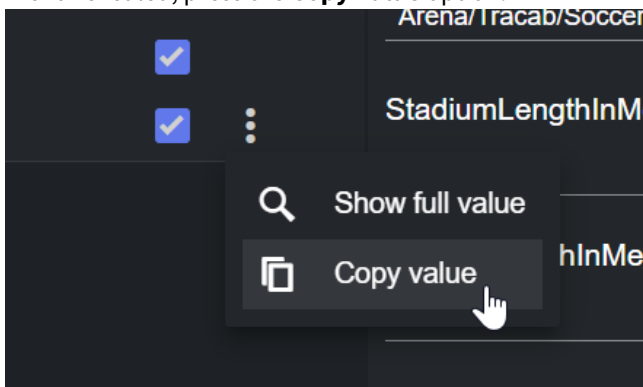

- To copy a dataset entry's key, hover over its key and click on the copy icon that is revealed:



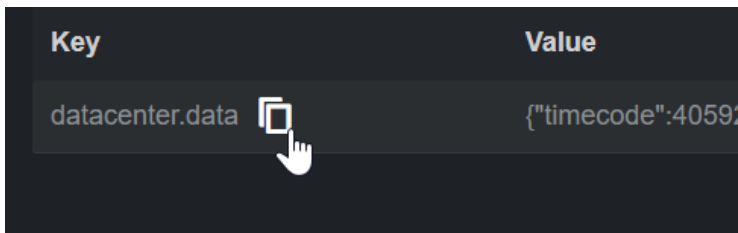

- After performing one of the copy actions, the copied value is available in the clipboard.

## Working with Live Data: Pause a Dataset View or Limit UI Updates



When working with real time data, inspecting or copying the incoming stream may be challenging, as the data at hand may be changing too fast. Therefore, the view of the data can be temporary paused or the entire UI refresh rate limited.

While the earlier affects only the view of a dataset, the latter slows down the view updates for all datasets. It is therefore recommended for cases using multiple datasets, and at least one has real-time data updates.

**Note:** While in pause mode, the incoming entries **are still forwarded** to all the configured outputs. Any assigned script to the dataset is also applied.

**Note:** Regardless of the mode selected, pausing a dataset view or limiting the UI updates have no effect on the Datacenter user interaction.

### Limit the UI Refresh Rate

To limit the UI refresh rate, click on the speedometer icon on the top right corner of the Application Bar . While running in limited mode, the speedometer icon turns yellow , and to remove the limit, click on the icon again. The limited refresh rate interval has a default value of 500 milliseconds. This value can be configured in the [General Configuration](#) section of the Admin page.

### Pause UI Updates

To pause UI updates click on the lock icon on the top of the data entries:

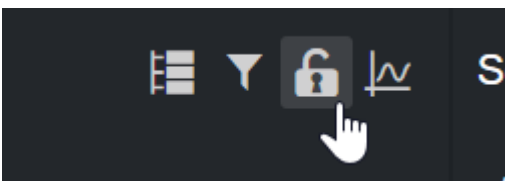

A yellow message informs that the data is not being updated for this dataset, while the entries are greyed out.

Dataset output

Search entries

Entries updates paused for this dataset (entries still sent to output)

Key	Value	
timecode	4068628	<input checked="" type="checkbox"/>
frame_nr	2034314	<input checked="" type="checkbox"/>
GlobalData.home.teamname	FC Bayern MÄnchen	<input checked="" type="checkbox"/>
GlobalData.home.shortteamname	FC Bayern	<input checked="" type="checkbox"/>
GlobalData.home.color.primary	black	<input checked="" type="checkbox"/>
GlobalData.home.color.secondary	black	<input checked="" type="checkbox"/>
GlobalData.home.players	[{"jerseynumber":26,"firstname":"Sven","lastname":"Ulreich","startingp...	<input checked="" type="checkbox"/>
GlobalData.home.jerseynumbers	26,4,2,19,5,27,6,10,42,7,39,43,40,3,38,45,41,8,11,9	<input checked="" type="checkbox"/>
GlobalData.away.teamname	RB Leipzig	<input checked="" type="checkbox"/>
GlobalData.away.shortteamname	Leipzig	<input checked="" type="checkbox"/>
GlobalData.away.color.primary	black	<input checked="" type="checkbox"/>
GlobalData.away.color.secondary	black	<input checked="" type="checkbox"/>
GlobalData.away.players	[{"jerseynumber":21,"firstname":"Janis","lastname":"Blaswich","startin...	<input checked="" type="checkbox"/>
GlobalData.away.jerseynumbers	21,39,4,2,24,20,44,22,17,7,11,25,23,16,10,13,18,30,9,38	<input checked="" type="checkbox"/>

All supported interactions with the data (copying or inspecting an entry) are still available while in pause mode.

### 5.4.5 Working with Live Data: the Performance Dashboard

When working with real-time data (data coming from a [Tracab](#) dataset), inspecting the performance of the incoming data streams, as well as applied scripts, can be crucial to spot problems in the pipeline. To help with this, Datcenter offers a **Performance Dashboard**.



The **Performance Dashboard** helps operators inspect the sanity of the incoming data, and the runtime of any applied script.

- To open the dashboard, click on the graph icon  in the Dataset Entries panel:

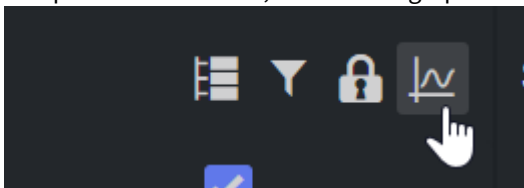

- Adjust the settings at the bottom of the dashboard to configure the viewing options.

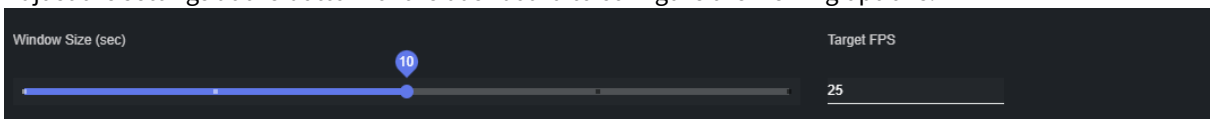

- Window Size:** Select the time span (in seconds) to inspect.
- Target FPS:** Configure these parameters to match the incoming stream FPS. This parameter, in combination with the **Window Size**, effectively configures how many frames are shown in the graph.

- To temporary freeze the dashboard updates, click anywhere on the graph. Clicking again resumes the updates.

### Intertimes

- Click on the **Intertimes** button at the top of the dashboard to show Interarrival times statistics.



The resulting graph shows the time elapsed, in milliseconds, between the reception of two 'packets' from a data stream.

The current average is reported in the title, and shown in light blue in the graph. When hovering on the chart, the intertime for that frame is revealed:



When inspecting intertimes, you can easily figure out if the incoming stream is sending packets slower or faster than the declared FPS. For the earlier, the reported average is larger than the ideal intertime average, while for the latter it is smaller.

### FPS

- Click on the **FPS** button at the top of the dashboard to show FPS (frames per second) statistics.

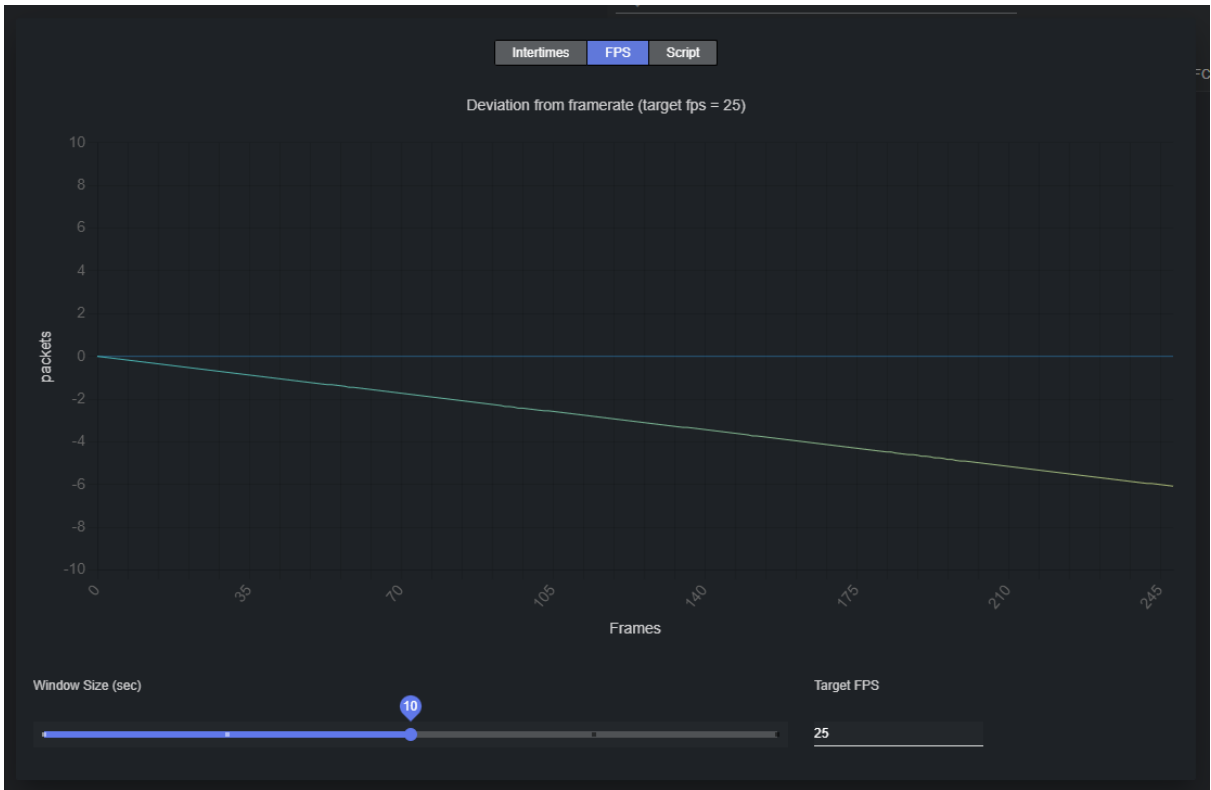

The resulting graph shows the difference between the ideal number of packets that the provider should have sent at a given frame and the actual number of received packets.

The current target FPS is reported in the title. When hovering on the chart, the deviation from the ideal framerate for that frame is revealed:

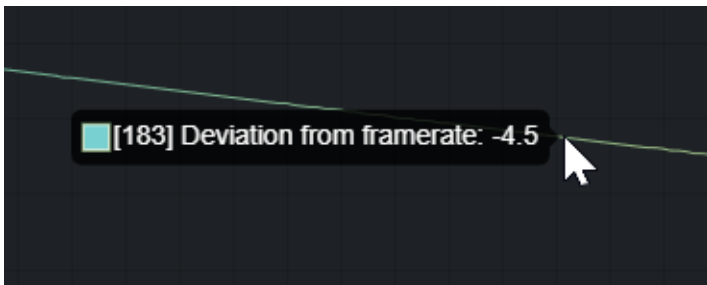

- When inspecting FPS stats, you can easily examine if the incoming stream is sending a different number of packets than the declared FPS. In case of a slower stream, the deviation should move towards the negative part of the Y axis over time.

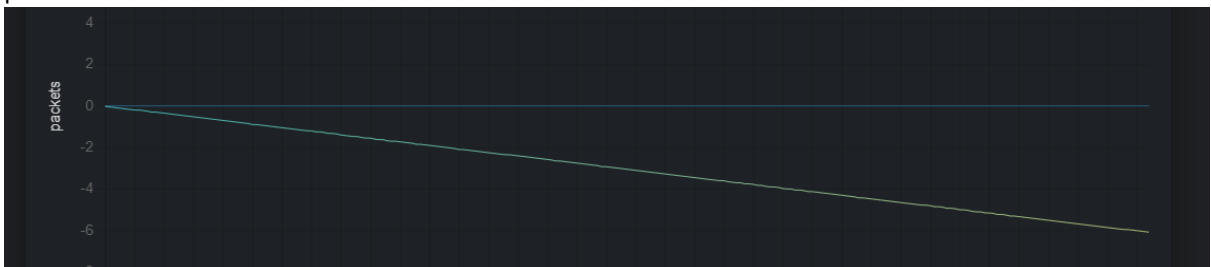

In the example above, an increasingly smaller number of packets than expected is received as the time advances.

Conversely, in case of faster stream, the deviation should move towards the positive Y axis over time.



In the example above, an increasingly larger number of packets than the expected is received as the time advances.

## Script

- Click on the **Script** button at the top of the dashboard to show script execution time (in milliseconds) statistics.



The resulting graph shows the execution time (in milliseconds) of the applied script, if any, over time.

## 5.4.6 Joining Endpoints Parameters

In Datacenter, it is possible to share parameters of different end points.

- When creating a dataset like with two end points that share same parameters, it looks as shown below:

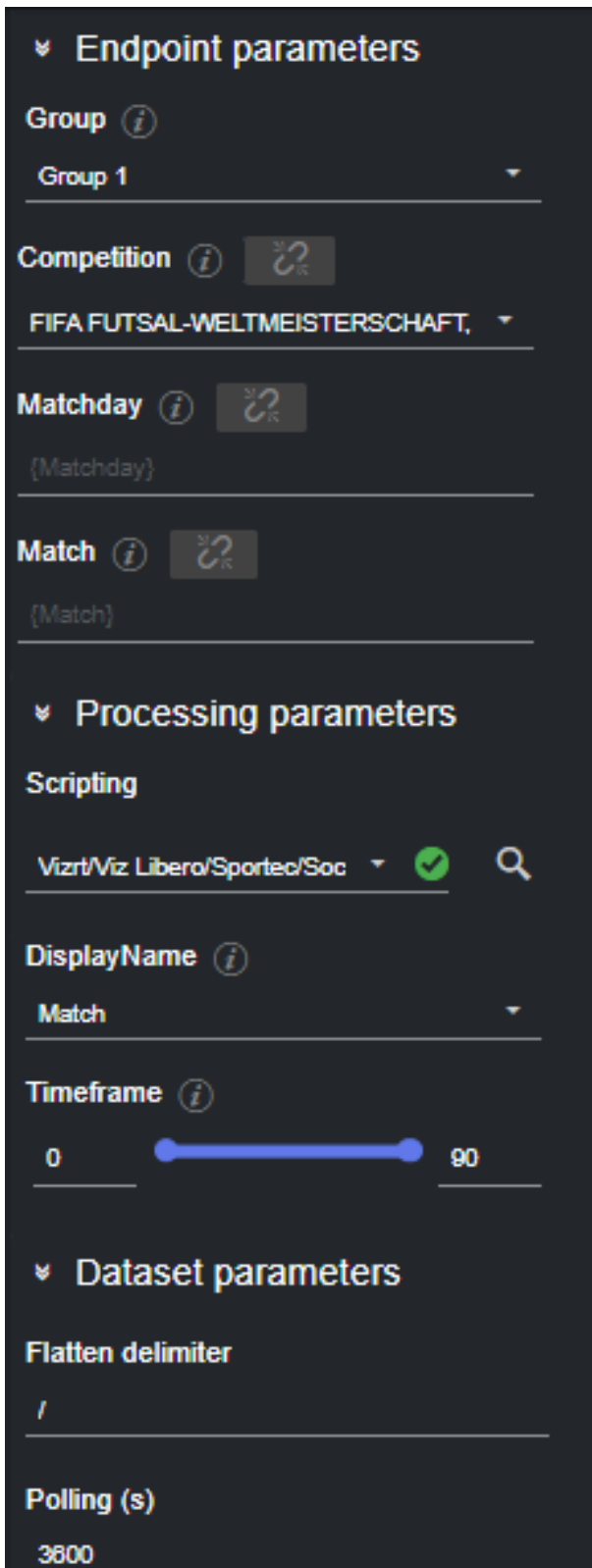

- To deactivate joining any end point parameters, put one end point in a different group:



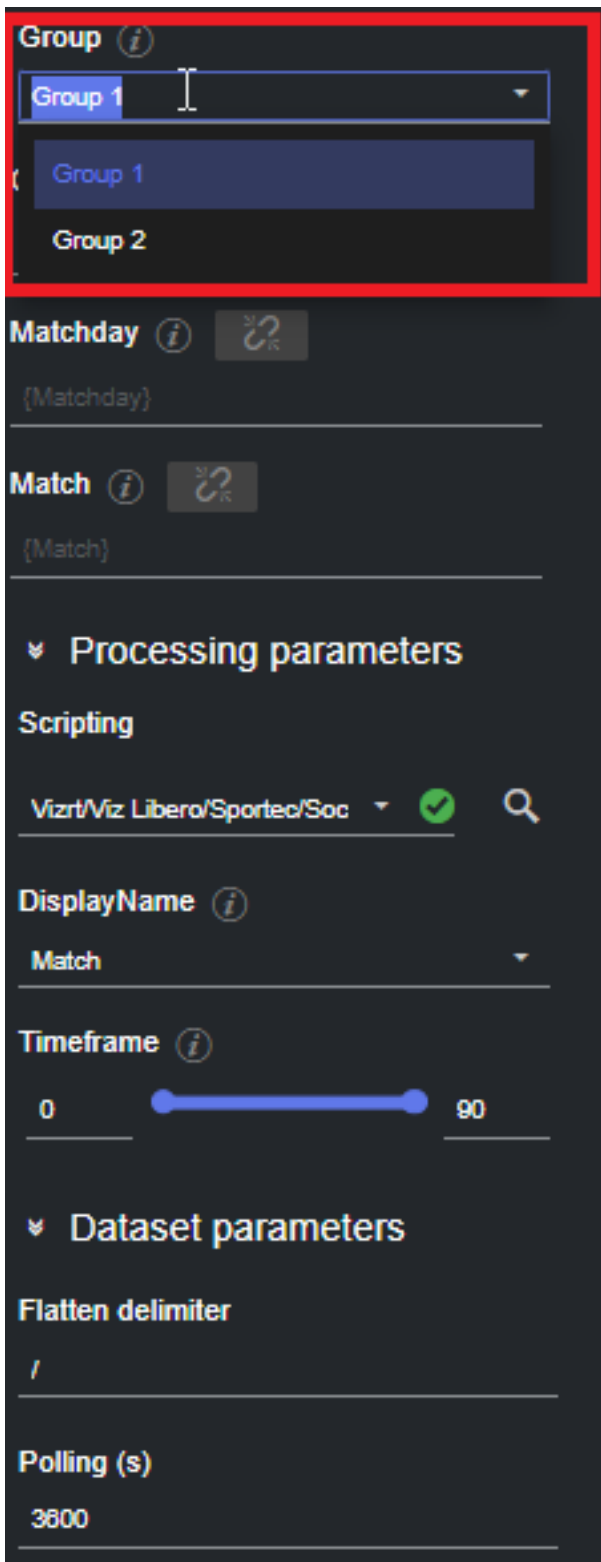

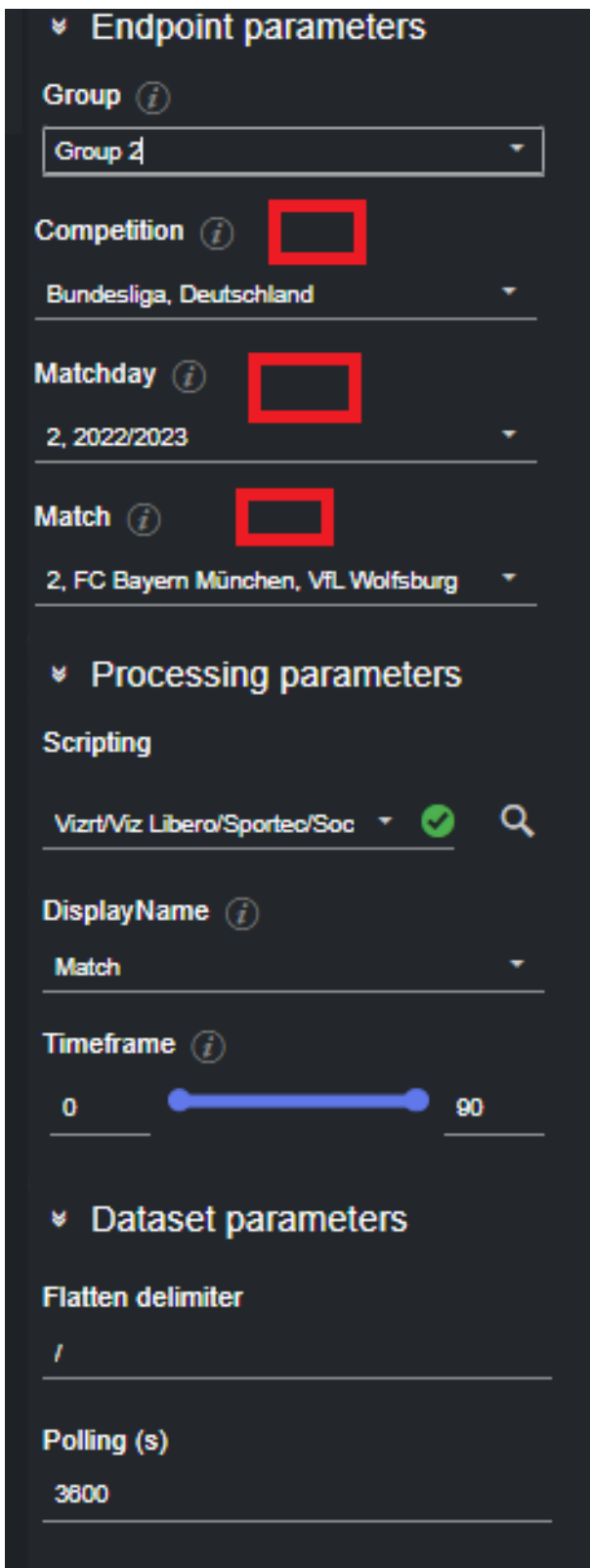

- This results in the following view, where the broken link icon disappears:

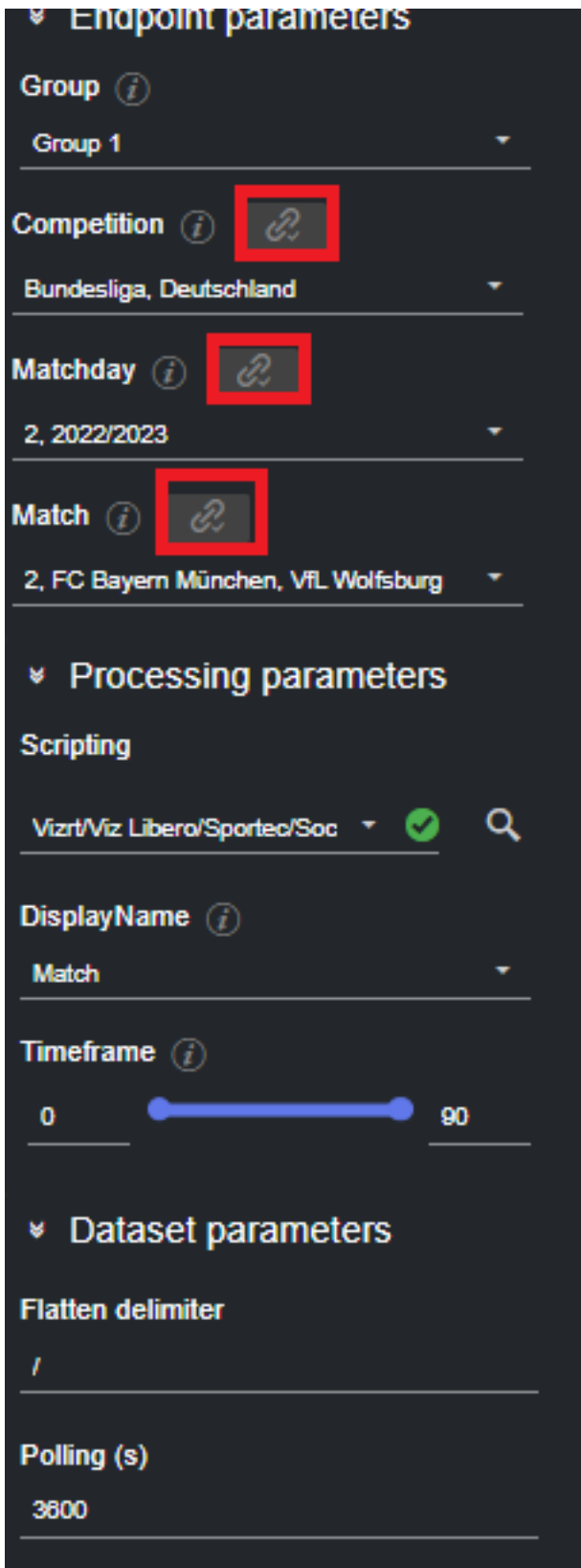

- To join endpoint parameters first make sure that the endpoints are in the same group, then click on the broken link icon:



- If the connected link icon is active, then the endpoint parameters of all endpoints in the group are joint. To break the connection just click on the icon again  →  .

## 5.5 Outputs

This section describes how to configure the following outputs in Datacenter:

- [Viz Engine Output](#)
- [Viz Arc Output](#)
- [Generic TCP Output](#)

Please refer to the [Configuring Outputs](#) section for steps on how to correctly setup each supported receiving end to accept incoming data from Datacenter.

### 5.5.1 Overview

Datacenter provides data to one or more outputs, so graphics can be linked to it seamlessly. To do so, first create and configure the desired output(s), which is then listed at the bottom of the main UI, in the **Viz Outputs footer**.

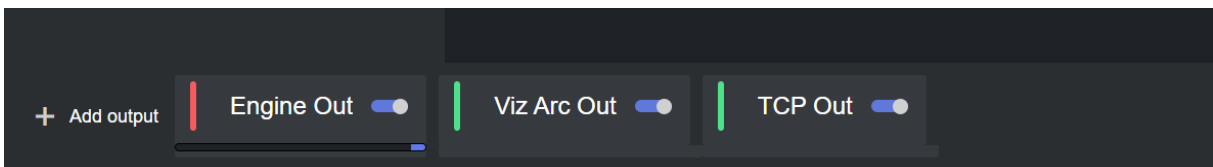

Each output can be either in Connected state (green) or not connected (red):

State	View	Description
Connected		Connected successfully.
Not Connected		When not connected, an output periodically attempts to reconnect. A progress bar appears at the bottom of the connecting output, and the tooltip shown when hovering on the status bar informs the user of any warnings or errors.

### 5.5.2 Add and Edit an Output

Add an output by clicking on the **Add output** button in the bottom left of the **Viz Outputs footer**.

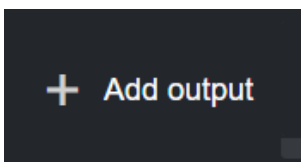

To configure or edit an output, click on its name in the output list, and edit the fields that are listed in the dialog that appears.

**Info:** When editing an output, click on **Confirm** to apply changes, or they are lost when closing the dialog.

Connected

Name

Local Preview

Type

Viz Engine

Host

localhost

Port TCP (General communication port)

6100

Check connection every (ms)

10000

Send to

Global SMM  Scene Local SMM

Connection mode

Auto

SMM UDP

*i* 6100

SMM TCP

*i* 7100

Scene ID

*i* #3152

Delete Confirm

After adding and configuring an Output, a connection is attempted.

### 5.5.3 Disable an Output

An output can be temporarily disabled by using the toggle next to its name in the Output list. When disabled, the output does not receive incoming data from Datacenter.

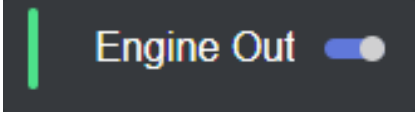
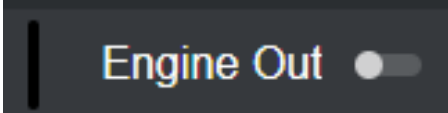
State	Enabled	Disabled
		

## 5.5.4 Viz Engine Output

To create an output of type Viz Engine, add a new output and click on the new entry.

On the dialog shown, select **Viz Engine** in the **Type** field, and fill all other fields as required:

Connected

Name

Local Preview

Type

Viz Engine

Host

localhost

Port TCP (General communication port)

6100

Check connection every (ms)

10000

Send to

Global SMM  Scene Local SMM

Connection mode

Auto

SMM UDP

*i* 6100

SMM TCP

*i* 7100

Scene ID

*i* #3152

Delete Confirm

- **Name:** Name of the output that is displayed in the output list.



- **Type:** Output type, set it to Viz Engine.
- **Host:** Host address where the Viz Engine runs.
- **Port TCP (General Communication port):** The port used to communicate with Viz Engine. This must match the port specified in the [Viz Engine Configuration](#) under **Config > Communication > General Communication Port**.
- **Check connection every (ms):** Specifies how often the communication between the Viz Engine and Datacenter is health-checked.

**Note:** You can temporarily increase the value of the **Check connection every (ms)** field if the messages sent to Viz Engine appear too often in the Viz Engine console while trying to use it. However, leaving this setting to 1000 ms is strongly recommended to be able to timely detect potential connection issues.

- **Send to:** Toggle between communication done via **Global Shared Memory Map** (default, typically used with Control Objects) and **Scene Local Shared Memory Map** (typically used with Control Channels).
- **Connection mode:** Specifies the communication protocol to use when sending data to the Viz Engine:
  - **Auto:** Prefers UDP, but switch to TCP each time the packet size exceeds 1.5kB.
  - **UDP:** Use UDP, regardless of the packet size.
  - **TCP:** Use TCP, regardless of the packet size.
- **SMM UDP:** Read only and auto-populated field, is the port to use for data communication to the Viz Engine. Only available if **Connection mode** is set to **UDP** or **Auto**.
- **SMM TCP:** Read only and auto-populated field, is the port to use for data communication to the Viz Engine. Only available if **Connection mode** is set to **TCP** or **Auto**.
- **Scene ID:** Read only and auto-populated field. Only available if **Send to** is set to **Global SMM**.

**Note:** If any of the SMM ports are not correctly configured, a warning symbol is displayed next to the **SMM UDP/TCP** fields. If that is the case, please refer to the [Configuring Output](#) section to correctly configured the ports.

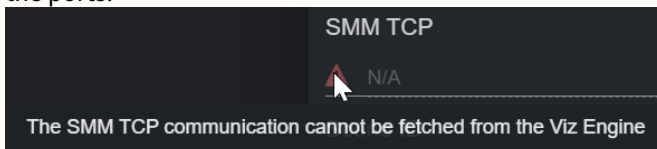

To learn more about configuring a Viz Engine to accept incoming data from Datacenter, please refer to the [Configuring Output](#) section.

To learn more about preparing your Viz Engine scene to accept incoming data, please refer to [Prepare Scenes for Data Input in Viz Artist](#).

### Custom Mapping of Dataset Keys

To facilitate matching input data with existing control channels/objects on a configured Viz Engine setup, Datacenter offers a way to intuitively map input entries keys to known Viz Engine channels/objects.

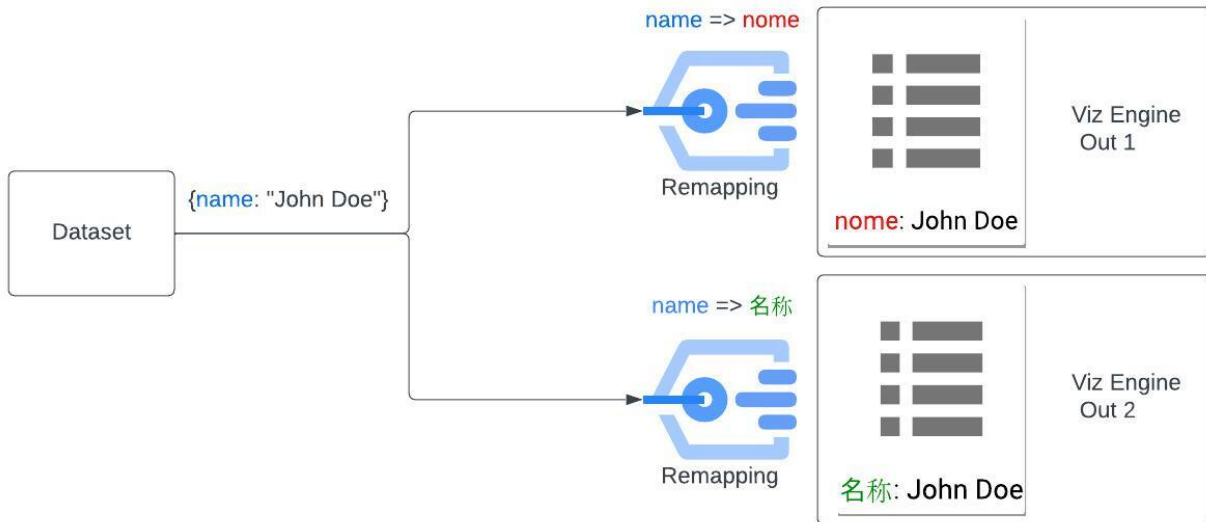

To do so, select a dataset from the **Datasets** panel and click on the custom mapping icon on the engine output to edit:

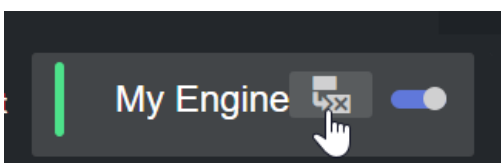
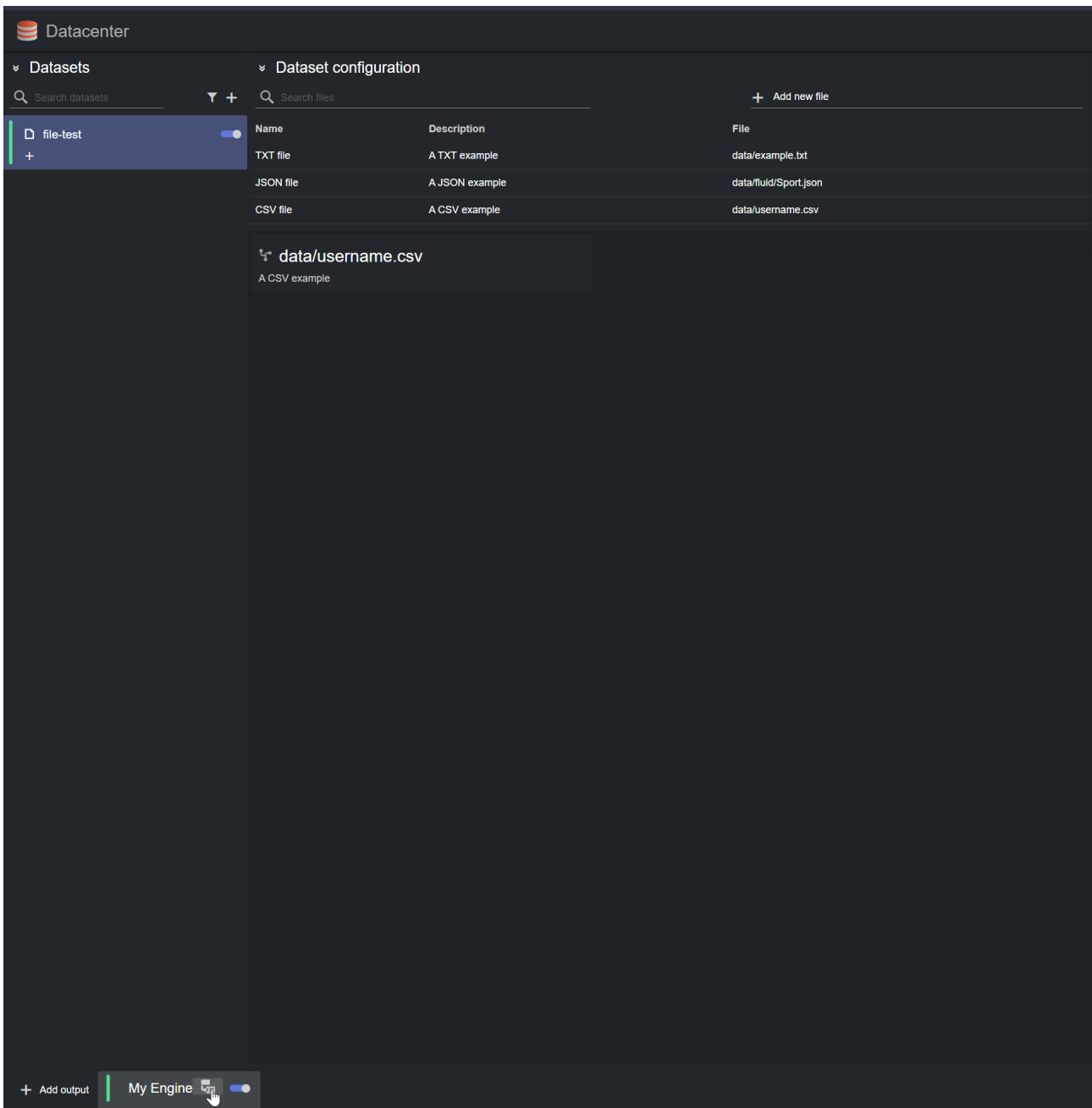

All current keys are listed in the dialog shown. Next to each, there's a search-box to search for all the advertised control channels and control objects on the selected viz Engine output.

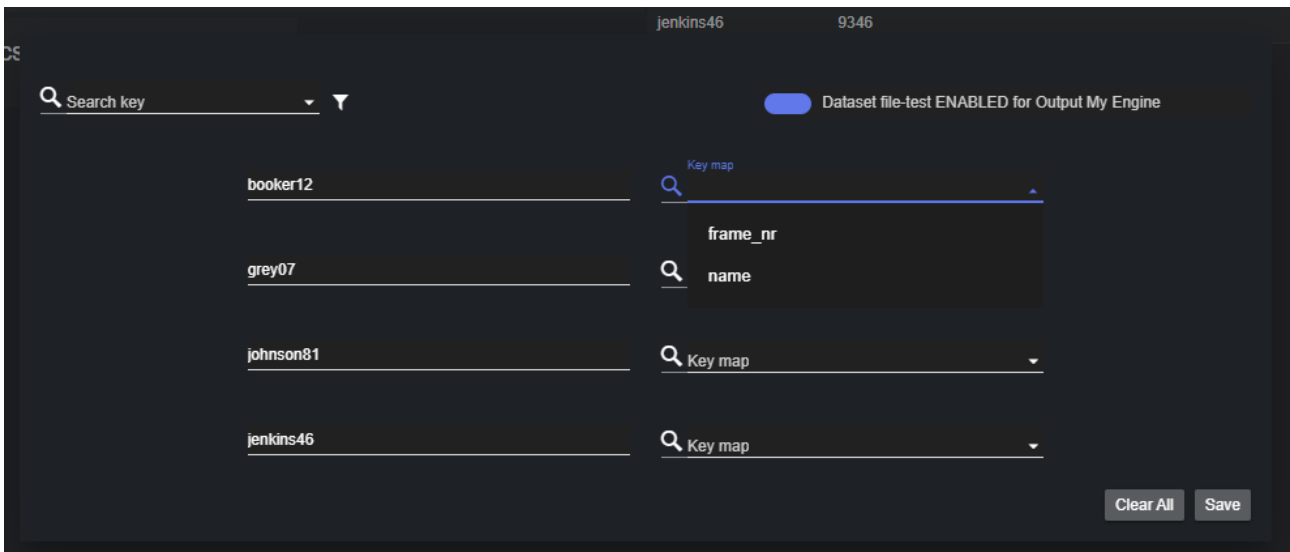

In the example above, the input dataset "file-test" has four keys ("booker12", "grey07", "johnson81" and "jenkins46"), while the selected Viz Engine "My Engine" exposes two control channels/objects ("frame\_nr" and "name").

You can now choose a custom mapping for any input key, by simply selecting a value from the right-side search-box:

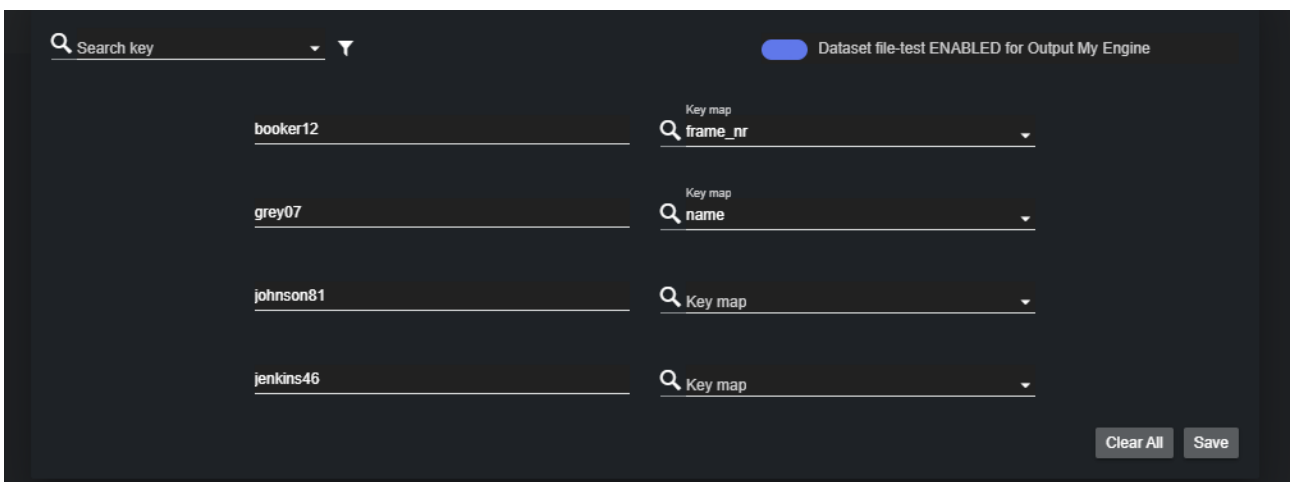

For example, the picture above shows the current custom mapping:

- booker12 → frame\_nr
- grey07 → name
- johnson81 → johnson81
- jenkins46 → jenkins46

By clicking **Save**, the current mapping is applied. **Clear All** resets the mapping to its default value (input keys not remapped).

When a custom mapping is applied to a dataset, selecting that dataset reveals a green dot next to the output name:

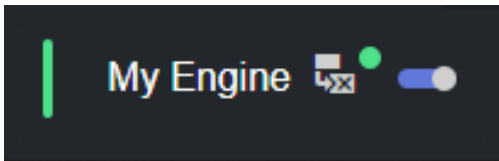

For example, the picture below shows the case where the Dataset "*file-test*" has a custom mapping specified for the output "*My Engine*" but **not** for the output "*My output*".

The screenshot displays a user interface with a dark theme. On the left, a sidebar titled "Datasets" contains a search bar and two entries: "manual-file" and "file-test", each with a plus sign and a toggle switch. The "file-test" entry is selected. The main area is titled "Dataset configuration" and features a search bar and a table with columns "Name" and "Description". The table lists "TXT file", "JSON file", and "CSV file". Below the table, a file icon is shown next to the text "data/username.csv" and "A CSV example". At the bottom, there is a footer with an "Add output" button, a "My Engine" label with a toggle switch, and a "My output" label with a toggle switch.

**Dataset configuration**

Name	Description
TXT file	A TXT example
JSON file	A JSON example
CSV file	A CSV example

data/username.csv  
A CSV example

+ Add output | My Engine  | My output

## Disable Sending Dataset Entries for a Viz Engine Output

In certain setups, a specific dataset may not be required on a specific Viz Engine output. In these cases, sending all dataset entries can be disabled by using the [custom mapping of dataset keys functionality](#).

To do so, select a dataset from the **Datasets** panel and click on the custom mapping icon on the engine output to edit:

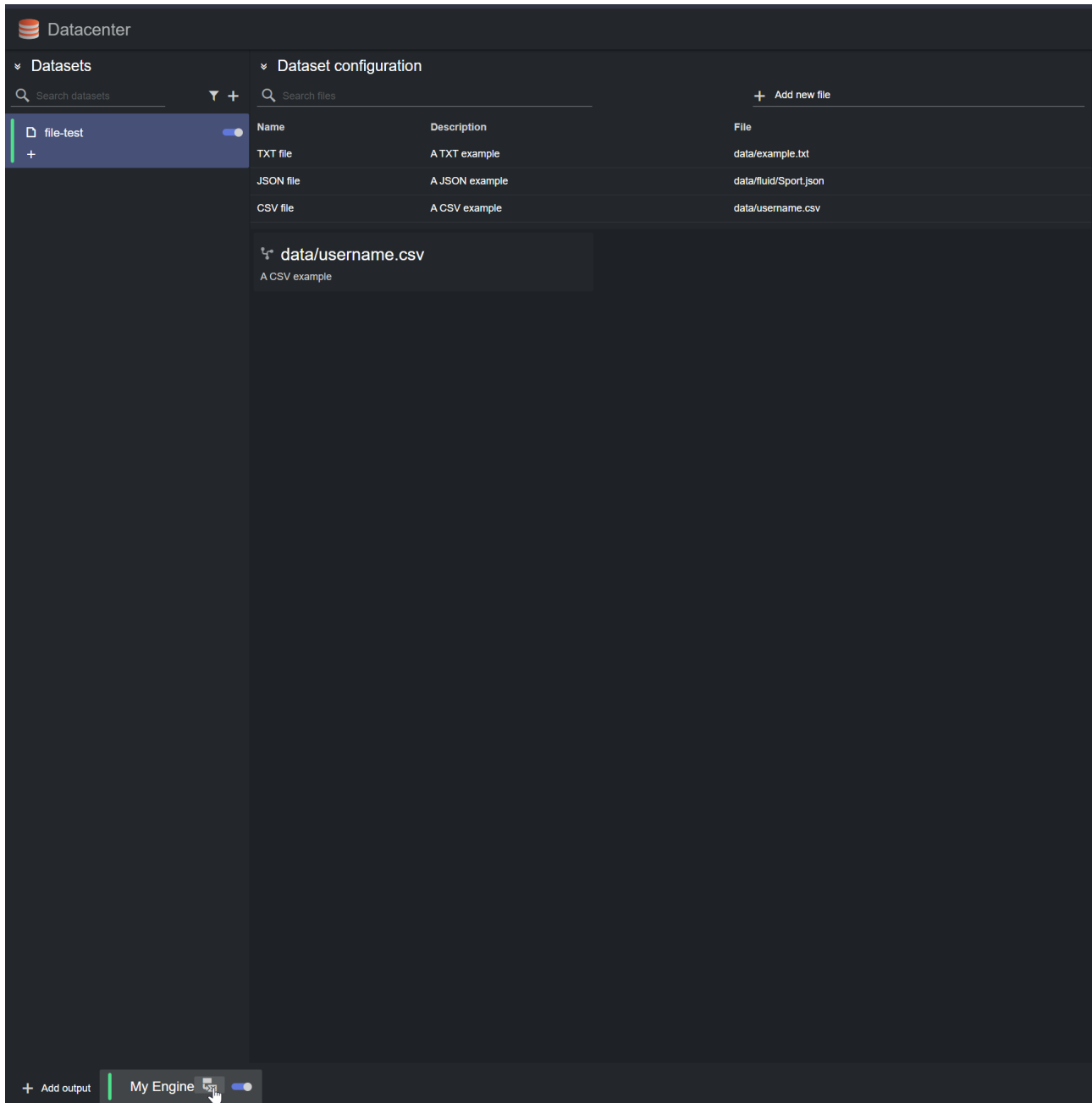

The screenshot displays the Datacenter interface with two main panels: 'Datasets' and 'Dataset configuration'. The 'Datasets' panel on the left shows a search bar and a list of datasets, with 'file-test' selected and a toggle switch turned on. The 'Dataset configuration' panel on the right shows a search bar, an 'Add new file' button, and a table of dataset entries. Below the table, a preview of the selected 'data/username.csv' dataset is shown.

Name	Description	File
TXT file	A TXT example	data/example.txt
JSON file	A JSON example	data/fluid/Sport.json
CSV file	A CSV example	data/username.csv

data/username.csv  
A CSV example

At the bottom of the interface, there is an 'Add output' button and a 'My Engine' section with a toggle switch and a custom mapping icon.

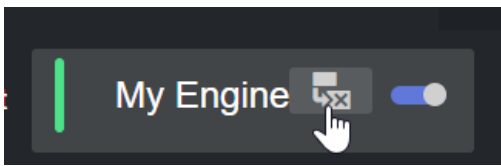

In the dialog that appears, switch the toggle in the right corner to **Dataset <dataset name> DISABLED for Output <output name>**, and press the **Save** button.

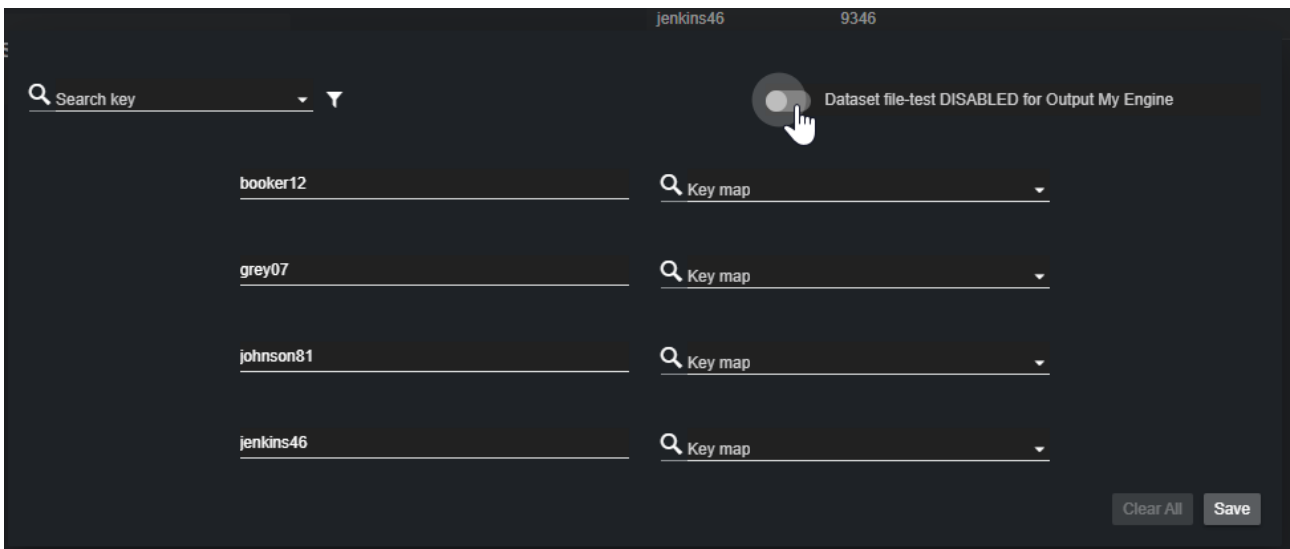

The output card should show a green dot, to signal that a custom mapping is specified for the selected Dataset:

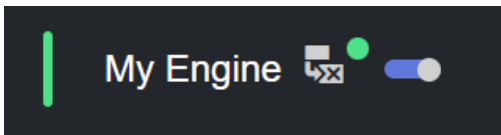

From now on, updates to the entries of the selected dataset are not sent to the selected output.



## Prepare Scenes for Data Input in Viz Artist

When working with a Viz Engine output, the scenes that receive live data from Datacenter, must be correctly prepared, depending on the communication option selected.

## Global Shared Memory Map Communication via Control Objects

Control objects communication is the default option when creating a new [Viz Engine output](#).

For the communication to work, the Viz Engine scene must enable **Use shared memory placeholders** for the control plugins that are updated with data. The following control plugins support Global Shared memory placeholder out of the box:

- ControlText
- ControlParameter
- ControllImage

To enable live data input from Datacenter:

1. Open the scene in **Viz Artist**.
2. Locate the control plugin for the field that should receive live input.
3. Check **Use shared memory placeholders**. Note that this enables listening for shared memory in the System (Global) memory map.

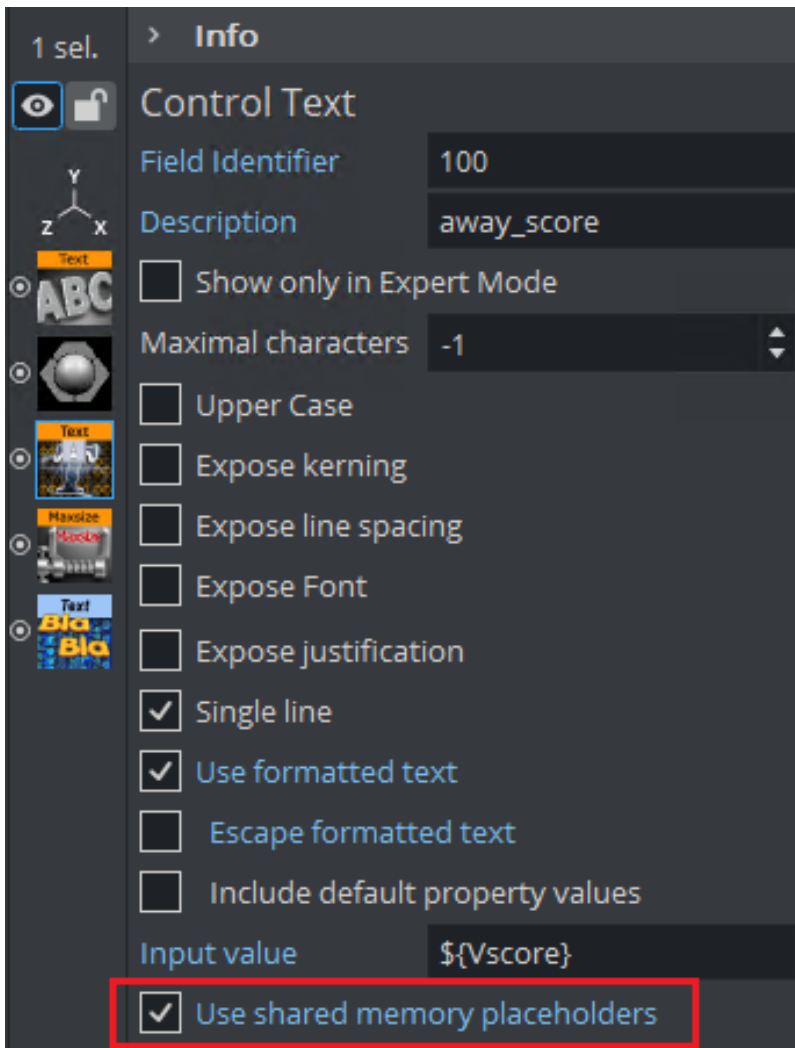

4. Set the **Input value** field to the *key* of the Datacenter dataset entry that should update this object, using the `${KEY_NAME}` syntax (in the example above the value would be updated with a dataset entry with key `Vscore`).
5. Save the scene.

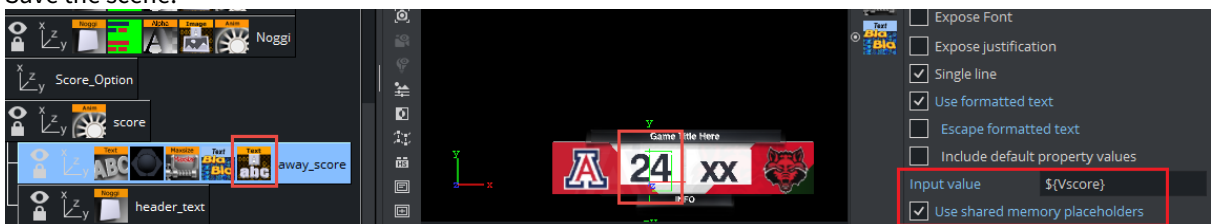

### Scene-local Shared Memory Map Communication via Control Channels

Control channels communication must be enabled on each [Viz Engine output](#) that uses it. To do so, click on the output you want to send data to and enable the **Control channels** toggle.

Connected

Name

Engine Out

---

Type

Viz Engine ▼

---

Host

localhost

---

Port

6100

---

Control channels

UDP

12000

---

Scene ID

#1289

---

Delete Confirm

**Scene ID Fetching:** Make sure that the scene is loaded in Viz Artist before connecting to Viz Engine, as the Output automatically fetches the Scene ID of the main scene. Should there be an error reported in the **Scene ID** field, or should you change the scene in Viz Artist after having connected to it, please temporarily disable and re-enable the output to force a new scene ID fetch.

Then, to enable live data input from Datacenter:

1. Open the scene in **Viz Artist**.
2. Locate the container that should receive live input, and the container field that should be updated with data from the Datacenter.

3. Drag the field in the Control Channels panel of Viz Artist.

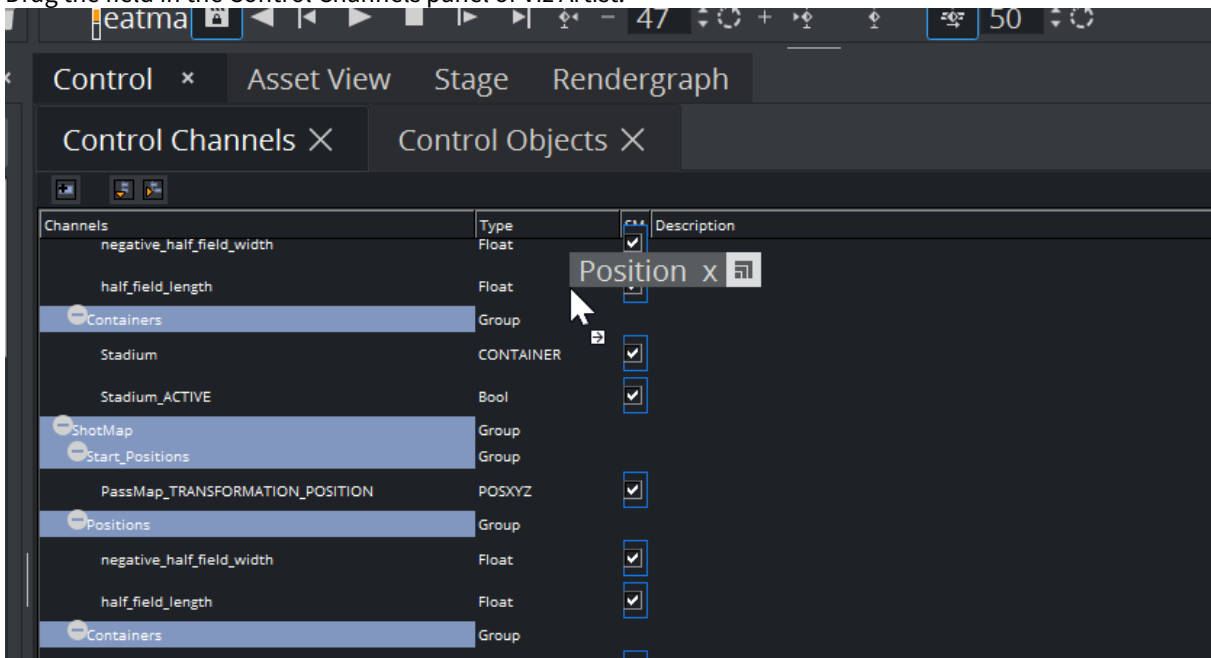

4. In the dialog that appears, set the Control Channel name to the *key* of the dataset entry that should update this object (in the example below the value would be updated with a dataset entry with key *my-entry-key*).

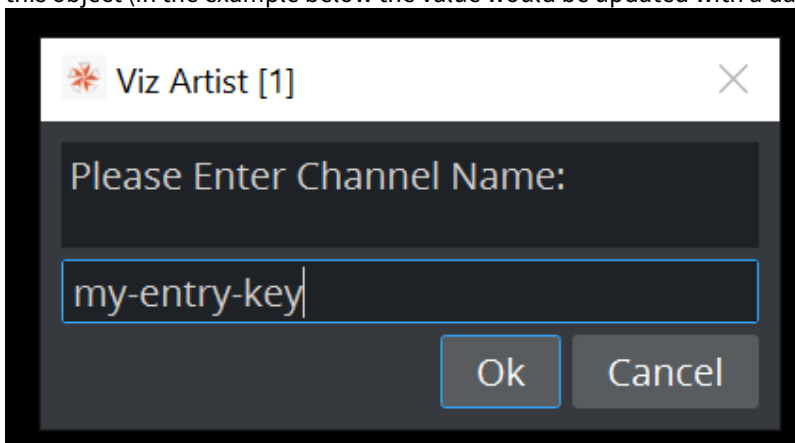

5. Make sure to enable the control channel by clicking on the SM column

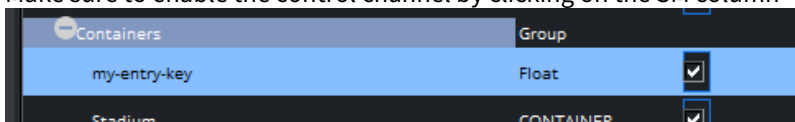

**Control Channel Groups:** Control channels in Viz Engine can be organized in Groups. Groups can be created using the  icon in the Control channels panels.

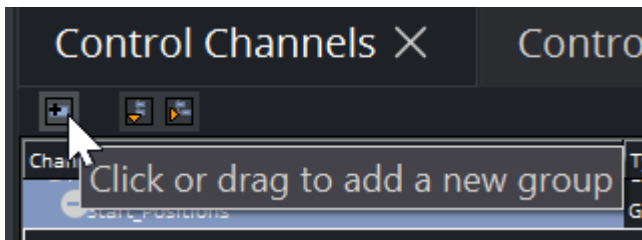

To access a control channel inside a group one must use the '.' delimiter. For example, the *my-entry-key* channel in the example below can be accessed using the following SHM key: *Containers.my-entry-key*.

Group	Type
Containers	Group
my-entry-key	Float

This property is particularly useful when flattening data in a Datacenter dataset. By setting the flattening delimiter to '.', one can organize the control channels to reflect the flattened data structure.

### 5.5.5 Viz Arc Output

To create an output of type Viz Arc, add a new output and click on the new entry.

On the dialog shown, select **Viz Arc** in the **Type** field, and fill all other fields as required:

**Connected**

Name  
My output

Type  
Viz Arc

Host  
localhost

Port  
5004

Check connection every (ms)  
1000

Delete Confirm

- **Name:** Name of the output that is displayed in the output list.
- **Host:** Host address where Viz Arc runs.
- **Port:** The port to connect to.
- **Check connection every (ms):** Specifies how often the communication between Viz Arc and Datacenter is health-checked.

To learn more about configuring Viz Arc to accept incoming data from Datacenter, please refer to the [Configuring Output](#) section of this manual.

## 5.5.6 Generic TCP Output

To create an output of type Generic TCP, add a new output and click on the new entry.

On the dialog that appears, select **Generic TCP** in the **Type** field, and fill all other fields as required:

Waiting to connect

Name  
My output

Type  
Generic TCP

Host  
localhost

Port  
6150

Delete Confirm

- **Name:** Name of the output and that is displayed in the output list.
- **Host:** Host address.
- **Port:** The port to connect to.

A generic TCP output sends the data entries with the following format:

```
{
  "type": "data",
  "payload": {
    "key": "entry_key",
    "value": "entry_value"
  }
}
```

A ping packet is also sent regularly to test the connection. This packet can be ignored by the receiver:

```
{
```

```
"type": "ping",  
"payload": null  
}
```

A TCP output is used to send data to Viz Libero. To learn more about configuring Viz Libero to accept incoming data from Datacenter, please refer to the [Configuring Output](#) section of this manual.



---

## 6 Alternative Views

Datacenter can be run in "simplified" mode, where some of its panels are hidden to create a focus view, or information relevant for a certain integration (for example, integration with Viz Libero) is shown.

This section goes through the simplified views supported by Datacenter, each accessible via a unique URL:

- [Simple Page](#)
- [Configurable Page](#)

## 6.1 Simple Page

The simple page is accessible via `<datacenter_url>/simple` (for example, <http://127.0.0.1:5700/simple>), and provides a minimalistic UI that allows the selection of endpoints through the pre-configured tags (see [Creating Datasets](#)).

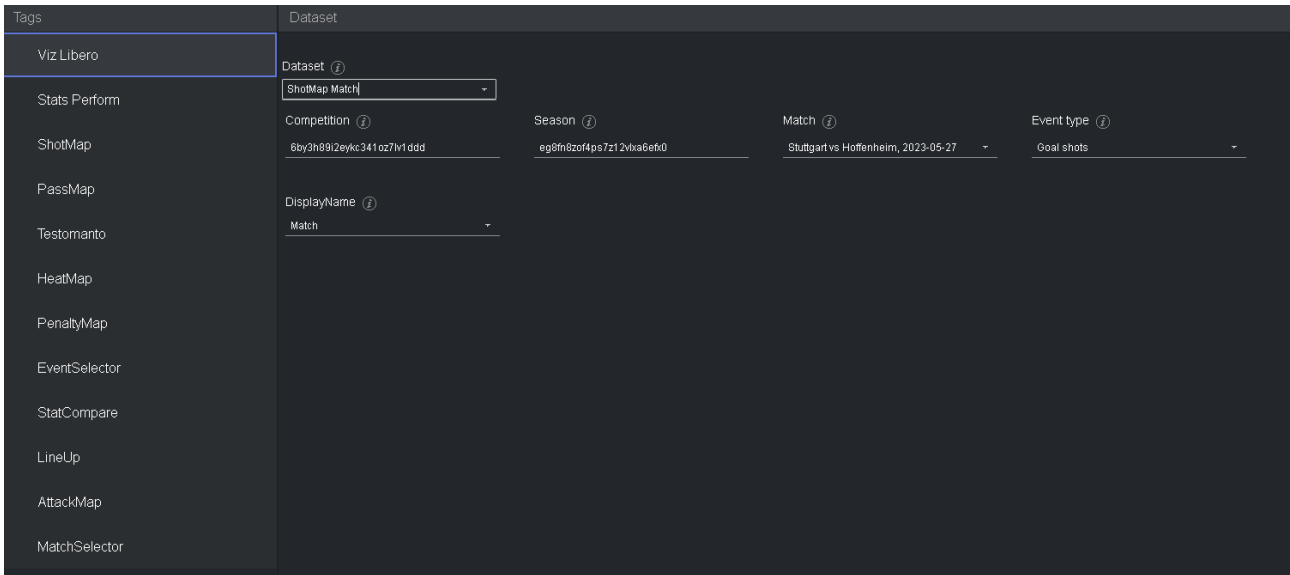

Tags can be selected directly through the UI or passed as an argument in the URL (for example, <http://127.0.0.1:5700/simple?tags=Viz%20Libero,ShotMap>).

If the tags are passed in the URL, the **Tags** column is not shown and only datasets relevant for the given tags are available for selection. If, given the tag filtering, only one dataset is available, it is automatically selected.

## 6.2 Configurable Page

The configurable page is accessible via `<datacenter_url>/?components=<ComponentsCommaSeparatedList>` (for example, <http://127.0.0.1:5700/?components=DatasetPanel>), and gives the option to create configurable views that can, for instance, improve focus or remove unnecessary panels from the main UI for a given workflow.

The available configurable components are:

1. Dataset Panel
2. Dataset Edit Panel
3. Dataset Entries Panel
4. Properties Panel
5. Outputs Panel

They must be specified as a comma separated list argument to the `?components` query element, representing respectively:

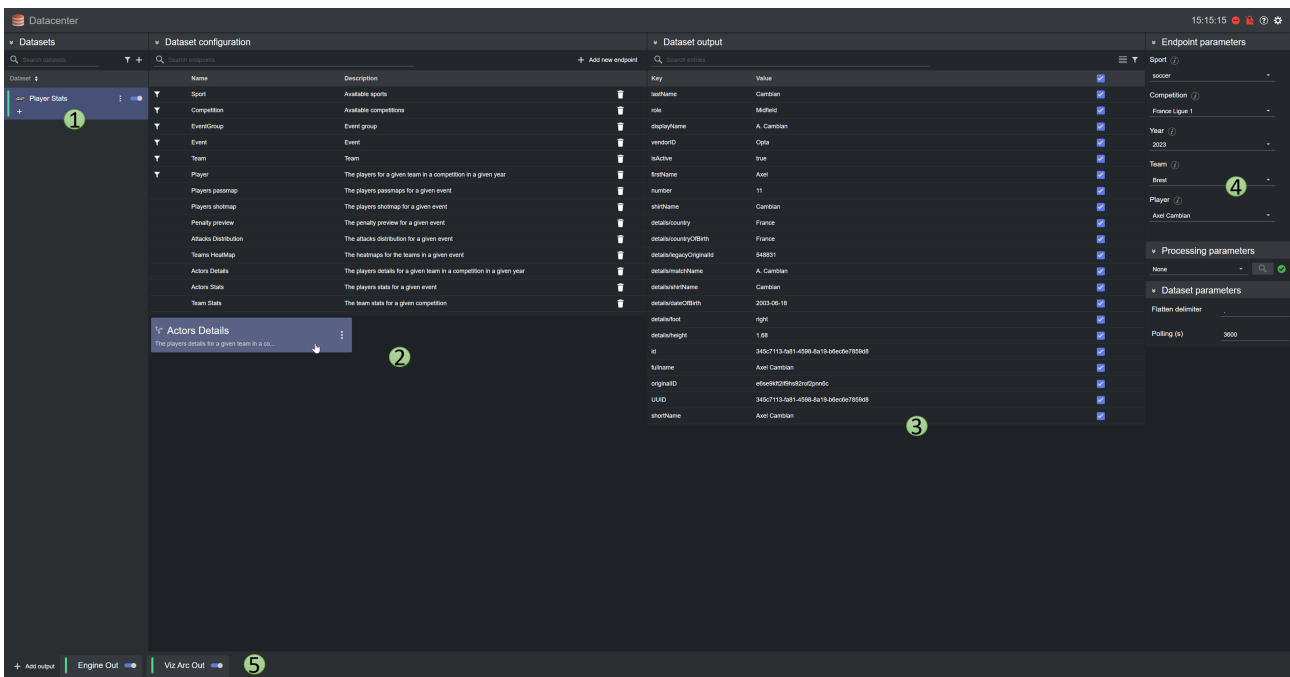

For example, the <http://127.0.0.1:5700/?components=DatasetPanel,DataEntriesPanel> creates a simplified view where only the configured datasets and their data entries are shown:

The screenshot shows the Datacenter application interface. On the left, there is a sidebar with a 'Player Stats' section. The main area displays a 'Dataset output' table with the following data:

Key	Value
lastName	Carlsen
no	145656
firstName	A. Carlsen
gender	Male
isActive	True
fullName	Anders
number	11
cityName	Oslo
stateCountry	Norway
stateCountryOSM	Norway
stateCountryOriginal	NO
stateShortName	N
stateFullName	Norway
stateOSM	NO
stateShort	NO
stateHeight	1.88
id	346c7115-5ab1-4598-8a13-066cbe7959d8
fullName	Anders Carlsen
original	anders@osm.org
UID	346c7115-5ab1-4598-8a13-066cbe7959d8
shortName	Anders Carlsen

---

## 7 Third-Party Licenses

If required by any of these licenses, Vizrt Inc. will provide source code and/or binaries used in the respective product.

If you have any queries regarding third party components, please contact Vizrt at [orange@vizrt.com](mailto:orange@vizrt.com).

This section contains information about the following third party software licenses:

- [ASP.NET Core](#)
- [Confluent Kafka for .NET](#)
- [Coverlet](#)
- [JUnitTestLogger](#)
- [moq4](#)
- [NJsonSchema for .NET](#)
- [Node.js](#)
- [npm](#)
- [Sep](#)
- [Serilog](#)
- [Serilog Graylog Sink](#)
- [SportzCast Library](#)
- [Swashbuckle.AspNetCore](#)
- [Vite](#)
- [WixSharp](#)
- [xunit](#)

---

## 7.1 ASP.NET Core

The MIT License (MIT)

Copyright (c) .NET Foundation and Contributors

All rights reserved.

Permission is hereby granted, free of charge, to any person obtaining a copy of this software and associated documentation files (the "Software"), to deal in the Software without restriction, including without limitation the rights to use, copy, modify, merge, publish, distribute, sublicense, and/or sell copies of the Software, and to permit persons to whom the Software is furnished to do so, subject to the following conditions:

The above copyright notice and this permission notice shall be included in all copies or substantial portions of the Software.

THE SOFTWARE IS PROVIDED "AS IS", WITHOUT WARRANTY OF ANY KIND, EXPRESS OR IMPLIED, INCLUDING BUT NOT LIMITED TO THE WARRANTIES OF MERCHANTABILITY, FITNESS FOR A PARTICULAR PURPOSE AND NONINFRINGEMENT. IN NO EVENT SHALL THE AUTHORS OR COPYRIGHT HOLDERS BE LIABLE FOR ANY CLAIM, DAMAGES OR OTHER LIABILITY, WHETHER IN AN ACTION OF CONTRACT, TORT OR OTHERWISE, ARISING FROM, OUT OF OR IN CONNECTION WITH THE SOFTWARE OR THE USE OR OTHER DEALINGS IN THE SOFTWARE.

---

## 7.2 Confluent Kafka For .NET

Version 2.0, January 2004

<http://www.apache.org/licenses/>

### TERMS AND CONDITIONS FOR USE, REPRODUCTION, AND DISTRIBUTION

#### 1. Definitions.

"License" shall mean the terms and conditions for use, reproduction, and distribution as defined by Sections 1 through 9 of this document.

"Licensor" shall mean the copyright owner or entity authorized by the copyright owner that is granting the License.

"Legal Entity" shall mean the union of the acting entity and all other entities that control, are controlled by, or are under common control with that entity. For the purposes of this definition, "control" means (i) the power, direct or indirect, to cause the direction or management of such entity, whether by contract or otherwise, or (ii) ownership of fifty percent (50%) or more of the outstanding shares, or (iii) beneficial ownership of such entity.

"You" (or "Your") shall mean an individual or Legal Entity exercising permissions granted by this License.

"Source" form shall mean the preferred form for making modifications, including but not limited to software source code, documentation source, and configuration files.

"Object" form shall mean any form resulting from mechanical transformation or translation of a Source form, including but not limited to compiled object code, generated documentation, and conversions to other media types.

"Work" shall mean the work of authorship, whether in Source or Object form, made available under the License, as indicated by a copyright notice that is included in or attached to the work (an example is provided in the Appendix below).

"Derivative Works" shall mean any work, whether in Source or Object form, that is based on (or derived from) the Work and for which the editorial revisions, annotations, elaborations, or other modifications represent, as a whole, an original work of authorship. For the purposes of this License, Derivative Works shall not include works that remain separable from, or merely link (or bind by name) to the interfaces of, the Work and Derivative Works thereof.

"Contribution" shall mean any work of authorship, including the original version of the Work and any modifications or additions to that Work or Derivative Works thereof, that is intentionally submitted to Licensor for inclusion in the Work by the copyright owner or by an individual or Legal Entity authorized to submit on behalf of the copyright owner. For the purposes of this definition, "submitted" means any form of electronic, verbal, or written communication sent to the Licensor or its representatives, including but not limited to

communication on electronic mailing lists, source code control systems, and issue tracking systems that are managed by, or on behalf of, the Licensor for the purpose of discussing and improving the Work, but excluding communication that is conspicuously marked or otherwise designated in writing by the copyright owner as "Not a Contribution."

"Contributor" shall mean Licensor and any individual or Legal Entity on behalf of whom a Contribution has been received by Licensor and subsequently incorporated within the Work.

2. Grant of Copyright License. Subject to the terms and conditions of this License, each Contributor hereby grants to You a perpetual, worldwide, non-exclusive, no-charge, royalty-free, irrevocable copyright license to reproduce, prepare Derivative Works of, publicly display, publicly perform, sublicense, and distribute the Work and such Derivative Works in Source or Object form.
3. Grant of Patent License. Subject to the terms and conditions of this License, each Contributor hereby grants to You a perpetual, worldwide, non-exclusive, no-charge, royalty-free, irrevocable (except as stated in this section) patent license to make, have made, use, offer to sell, sell, import, and otherwise transfer the Work, where such license applies only to those patent claims licensable by such Contributor that are necessarily infringed by their Contribution(s) alone or by combination of their Contribution(s) with the Work to which such Contribution(s) was submitted. If You institute patent litigation against any entity (including a cross-claim or counterclaim in a lawsuit) alleging that the Work or a Contribution incorporated within the Work constitutes direct or contributory patent infringement, then any patent licenses granted to You under this License for that Work shall terminate as of the date such litigation is filed.
4. Redistribution. You may reproduce and distribute copies of the Work or Derivative Works thereof in any medium, with or without modifications, and in Source or Object form, provided that You meet the following conditions:
  - (a) You must give any other recipients of the Work or Derivative Works a copy of this License; and
  - (b) You must cause any modified files to carry prominent notices stating that You changed the files; and
  - (c) You must retain, in the Source form of any Derivative Works that You distribute, all copyright, patent, trademark, and attribution notices from the Source form of the Work, excluding those notices that do not pertain to any part of the Derivative Works; and
  - (d) If the Work includes a "NOTICE" text file as part of its distribution, then any Derivative Works that You distribute must include a readable copy of the attribution notices contained within such NOTICE file, excluding those notices that do not pertain to any part of the Derivative Works, in at least one of the following places: within a NOTICE text file distributed as part of the Derivative Works; within the Source form or



documentation, if provided along with the Derivative Works; or, within a display generated by the Derivative Works, if and wherever such third-party notices normally appear. The contents of the NOTICE file are for informational purposes only and do not modify the License. You may add Your own attribution notices within Derivative Works that You distribute, alongside or as an addendum to the NOTICE text from the Work, provided that such additional attribution notices cannot be construed as modifying the License.

You may add Your own copyright statement to Your modifications and may provide additional or different license terms and conditions for use, reproduction, or distribution of Your modifications, or for any such Derivative Works as a whole, provided Your use, reproduction, and distribution of the Work otherwise complies with the conditions stated in this License.

5. **Submission of Contributions.** Unless You explicitly state otherwise, any Contribution intentionally submitted for inclusion in the Work by You to the Licensor shall be under the terms and conditions of this License, without any additional terms or conditions. Notwithstanding the above, nothing herein shall supersede or modify the terms of any separate license agreement you may have executed with Licensor regarding such Contributions.
6. **Trademarks.** This License does not grant permission to use the trade names, trademarks, service marks, or product names of the Licensor, except as required for reasonable and customary use in describing the origin of the Work and reproducing the content of the NOTICE file.
7. **Disclaimer of Warranty.** Unless required by applicable law or agreed to in writing, Licensor provides the Work (and each Contributor provides its Contributions) on an "AS IS" BASIS, WITHOUT WARRANTIES OR CONDITIONS OF ANY KIND, either express or implied, including, without limitation, any warranties or conditions of TITLE, NON-INFRINGEMENT, MERCHANTABILITY, or FITNESS FOR A PARTICULAR PURPOSE. You are solely responsible for determining the appropriateness of using or redistributing the Work and assume any risks associated with Your exercise of permissions under this License.
8. **Limitation of Liability.** In no event and under no legal theory, whether in tort (including negligence), contract, or otherwise, unless required by applicable law (such as deliberate and grossly negligent acts) or agreed to in writing, shall any Contributor be liable to You for damages, including any direct, indirect, special, incidental, or consequential damages of any character arising as a result of this License or out of the use or inability to use the Work (including but not limited to damages for loss of goodwill, work stoppage, computer failure or malfunction, or any and all other commercial damages or losses), even if such Contributor has been advised of the possibility of such damages.
9. **Accepting Warranty or Additional Liability.** While redistributing the Work or Derivative Works thereof, You may choose to offer, and charge a fee for, acceptance of support, warranty, indemnity, or other liability obligations and/or rights consistent with this

License. However, in accepting such obligations, You may act only on Your own behalf and on Your sole responsibility, not on behalf of any other Contributor, and only if You agree to indemnify, defend, and hold each Contributor harmless for any liability incurred by, or claims asserted against, such Contributor by reason of your accepting any such warranty or additional liability.

#### END OF TERMS AND CONDITIONS

#### APPENDIX: How to apply the Apache License to your work.

To apply the Apache License to your work, attach the following boilerplate notice, with the fields enclosed by brackets "{}" replaced with your own identifying information. (Don't include the brackets!) The text should be enclosed in the appropriate comment syntax for the file format. We also recommend that a file or class name and description of purpose be included on the same "printed page" as the copyright notice for easier identification within third-party archives.

Copyright {yyyy} {name of copyright owner}

Licensed under the Apache License, Version 2.0 (the "License");  
you may not use this file except in compliance with the License.  
You may obtain a copy of the License at

<http://www.apache.org/licenses/LICENSE-2.0>

Unless required by applicable law or agreed to in writing, software distributed under the License is distributed on an "AS IS" BASIS, WITHOUT WARRANTIES OR CONDITIONS OF ANY KIND, either express or implied. See the License for the specific language governing permissions and limitations under the License.

Derived from: rdkafka-dotnet - C# Apache Kafka client library

Copyright (c) 2015-2016, Andreas Heider  
All rights reserved.

Redistribution and use in source and binary forms, with or without modification, are permitted provided that the following conditions are met:

1. Redistributions of source code must retain the above copyright notice, this list of conditions and the following disclaimer.
2. Redistributions in binary form must reproduce the above copyright notice, this list of conditions and the following disclaimer in the documentation and/or other materials provided with the distribution.

THIS SOFTWARE IS PROVIDED BY THE COPYRIGHT HOLDERS AND CONTRIBUTORS "AS IS" AND ANY EXPRESS OR IMPLIED WARRANTIES, INCLUDING, BUT NOT LIMITED TO, THE IMPLIED WARRANTIES OF MERCHANTABILITY AND FITNESS FOR A PARTICULAR PURPOSE ARE DISCLAIMED. IN NO EVENT SHALL THE COPYRIGHT OWNER OR CONTRIBUTORS BE LIABLE FOR ANY DIRECT, INDIRECT, INCIDENTAL, SPECIAL, EXEMPLARY, OR CONSEQUENTIAL DAMAGES (INCLUDING, BUT NOT LIMITED TO, PROCUREMENT OF SUBSTITUTE GOODS OR SERVICES; LOSS OF USE, DATA, OR PROFITS; OR BUSINESS INTERRUPTION) HOWEVER CAUSED AND ON ANY THEORY OF LIABILITY, WHETHER IN CONTRACT, STRICT LIABILITY, OR TORT (INCLUDING NEGLIGENCE OR OTHERWISE)

ARISING IN ANY WAY OUT OF THE USE OF THIS SOFTWARE, EVEN IF ADVISED OF THE POSSIBILITY OF SUCH DAMAGE.

---

## 7.3 Coverlet

The MIT License (MIT)

Copyright (c) 2018 Toni Solarin-Sodara

Permission is hereby granted, free of charge, to any person obtaining a copy of this software and associated documentation files (the "Software"), to deal in the Software without restriction, including without limitation the rights to use, copy, modify, merge, publish, distribute, sublicense, and/or sell copies of the Software, and to permit persons to whom the Software is furnished to do so, subject to the following conditions:

The above copyright notice and this permission notice shall be included in all copies or substantial portions of the Software.

THE SOFTWARE IS PROVIDED "AS IS", WITHOUT WARRANTY OF ANY KIND, EXPRESS OR IMPLIED, INCLUDING BUT NOT LIMITED TO THE WARRANTIES OF MERCHANTABILITY, FITNESS FOR A PARTICULAR PURPOSE AND NONINFRINGEMENT. IN NO EVENT SHALL THE AUTHORS OR COPYRIGHT HOLDERS BE LIABLE FOR ANY CLAIM, DAMAGES OR OTHER LIABILITY, WHETHER IN AN ACTION OF CONTRACT, TORT OR OTHERWISE, ARISING FROM, OUT OF OR IN CONNECTION WITH THE SOFTWARE OR THE USE OR OTHER DEALINGS IN THE SOFTWARE.

---

## 7.4 JUnitTestLogger

MIT License

Copyright (c) 2017 GMV Syncromatics Engineering

Permission is hereby granted, free of charge, to any person obtaining a copy of this software and associated documentation files (the "Software"), to deal in the Software without restriction, including without limitation the rights to use, copy, modify, merge, publish, distribute, sublicense, and/or sell copies of the Software, and to permit persons to whom the Software is furnished to do so, subject to the following conditions:

The above copyright notice and this permission notice shall be included in all copies or substantial portions of the Software.

THE SOFTWARE IS PROVIDED "AS IS", WITHOUT WARRANTY OF ANY KIND, EXPRESS OR IMPLIED, INCLUDING BUT NOT LIMITED TO THE WARRANTIES OF MERCHANTABILITY, FITNESS FOR A PARTICULAR PURPOSE AND NONINFRINGEMENT. IN NO EVENT SHALL THE AUTHORS OR COPYRIGHT HOLDERS BE LIABLE FOR ANY CLAIM, DAMAGES OR OTHER LIABILITY, WHETHER IN AN ACTION OF CONTRACT, TORT OR OTHERWISE, ARISING FROM, OUT OF OR IN CONNECTION WITH THE SOFTWARE OR THE USE OR OTHER DEALINGS IN THE SOFTWARE.

---

## 7.5 Moq4

### BSD 3-Clause License

Copyright (c) 2007, Clarius Consulting, Manas Technology Solutions, InSTEDD, and Contributors. All rights reserved.

Redistribution and use in source and binary forms, with or without modification, are permitted provided that the following conditions are met:

- \* Redistributions of source code must retain the above copyright notice, this list of conditions and the following disclaimer.
- \* Redistributions in binary form must reproduce the above copyright notice, this list of conditions and the following disclaimer in the documentation and/or other materials provided with the distribution.
- \* Neither the names of the copyright holders nor the names of its contributors may be used to endorse or promote products derived from this software without specific prior written permission.

THIS SOFTWARE IS PROVIDED BY THE COPYRIGHT HOLDERS AND CONTRIBUTORS "AS IS" AND ANY EXPRESS OR IMPLIED WARRANTIES, INCLUDING, BUT NOT LIMITED TO, THE IMPLIED WARRANTIES OF MERCHANTABILITY AND FITNESS FOR A PARTICULAR PURPOSE ARE DISCLAIMED. IN NO EVENT SHALL THE COPYRIGHT OWNER OR CONTRIBUTORS BE LIABLE FOR ANY DIRECT, INDIRECT, INCIDENTAL, SPECIAL, EXEMPLARY, OR CONSEQUENTIAL DAMAGES (INCLUDING, BUT NOT LIMITED TO, PROCUREMENT OF SUBSTITUTE GOODS OR SERVICES; LOSS OF USE, DATA, OR PROFITS; OR BUSINESS INTERRUPTION) HOWEVER CAUSED AND ON ANY THEORY OF LIABILITY, WHETHER IN CONTRACT, STRICT LIABILITY, OR TORT (INCLUDING NEGLIGENCE OR OTHERWISE) ARISING IN ANY WAY OUT OF THE USE OF THIS SOFTWARE, EVEN IF ADVISED OF THE POSSIBILITY OF SUCH DAMAGE.

---

## 7.6 NJsonSchema For .NET

The MIT License (MIT)

Copyright (c) 2016 Rico Suter

Permission is hereby granted, free of charge, to any person obtaining a copy of this software and associated documentation files (the "Software"), to deal in the Software without restriction, including without limitation the rights to use, copy, modify, merge, publish, distribute, sublicense, and/or sell copies of the Software, and to permit persons to whom the Software is furnished to do so, subject to the following conditions:

The above copyright notice and this permission notice shall be included in all copies or substantial portions of the Software.

THE SOFTWARE IS PROVIDED "AS IS", WITHOUT WARRANTY OF ANY KIND, EXPRESS OR IMPLIED, INCLUDING BUT NOT LIMITED TO THE WARRANTIES OF MERCHANTABILITY, FITNESS FOR A PARTICULAR PURPOSE AND NONINFRINGEMENT. IN NO EVENT SHALL THE AUTHORS OR COPYRIGHT HOLDERS BE LIABLE FOR ANY CLAIM, DAMAGES OR OTHER LIABILITY, WHETHER IN AN ACTION OF CONTRACT, TORT OR OTHERWISE, ARISING FROM, OUT OF OR IN CONNECTION WITH THE SOFTWARE OR THE USE OR OTHER DEALINGS IN THE SOFTWARE.

---

## 7.7 Node.js

Node.js is licensed for use as follows:

""""

Copyright Node.js contributors. All rights reserved.

Permission is hereby granted, free of charge, to any person obtaining a copy of this software and associated documentation files (the "Software"), to deal in the Software without restriction, including without limitation the rights to use, copy, modify, merge, publish, distribute, sublicense, and/or sell copies of the Software, and to permit persons to whom the Software is furnished to do so, subject to the following conditions:

The above copyright notice and this permission notice shall be included in all copies or substantial portions of the Software.

THE SOFTWARE IS PROVIDED "AS IS", WITHOUT WARRANTY OF ANY KIND, EXPRESS OR IMPLIED, INCLUDING BUT NOT LIMITED TO THE WARRANTIES OF MERCHANTABILITY, FITNESS FOR A PARTICULAR PURPOSE AND NONINFRINGEMENT. IN NO EVENT SHALL THE AUTHORS OR COPYRIGHT HOLDERS BE LIABLE FOR ANY CLAIM, DAMAGES OR OTHER LIABILITY, WHETHER IN AN ACTION OF CONTRACT, TORT OR OTHERWISE, ARISING FROM, OUT OF OR IN CONNECTION WITH THE SOFTWARE OR THE USE OR OTHER DEALINGS IN THE SOFTWARE.

""""

This license applies to parts of Node.js originating from the <https://github.com/joyent/node> repository:

""""

Copyright Joyent, Inc. and other Node contributors. All rights reserved. Permission is hereby granted, free of charge, to any person obtaining a copy of this software and associated documentation files (the "Software"), to deal in the Software without restriction, including without limitation the rights to use, copy, modify, merge, publish, distribute, sublicense, and/or sell copies of the Software, and to permit persons to whom the Software is furnished to do so, subject to the following conditions:

The above copyright notice and this permission notice shall be included in all copies or substantial portions of the Software.

THE SOFTWARE IS PROVIDED "AS IS", WITHOUT WARRANTY OF ANY KIND, EXPRESS OR IMPLIED, INCLUDING BUT NOT LIMITED TO THE WARRANTIES OF MERCHANTABILITY, FITNESS FOR A PARTICULAR PURPOSE AND NONINFRINGEMENT. IN NO EVENT SHALL THE AUTHORS OR COPYRIGHT HOLDERS BE LIABLE FOR ANY CLAIM, DAMAGES OR OTHER LIABILITY, WHETHER IN AN ACTION OF CONTRACT, TORT OR OTHERWISE, ARISING FROM, OUT OF OR IN CONNECTION WITH THE SOFTWARE OR THE USE OR OTHER DEALINGS IN THE SOFTWARE.

""""

The Node.js license applies to all parts of Node.js that are not externally maintained libraries.

The externally maintained libraries used by Node.js are:



- Acorn, located at deps/acorn, is licensed as follows:

""""

MIT License

Copyright (C) 2012-2022 by various contributors (see AUTHORS)

Permission is hereby granted, free of charge, to any person obtaining a copy of this software and associated documentation files (the "Software"), to deal in the Software without restriction, including without limitation the rights to use, copy, modify, merge, publish, distribute, sublicense, and/or sell copies of the Software, and to permit persons to whom the Software is furnished to do so, subject to the following conditions:

The above copyright notice and this permission notice shall be included in all copies or substantial portions of the Software.

THE SOFTWARE IS PROVIDED "AS IS", WITHOUT WARRANTY OF ANY KIND, EXPRESS OR IMPLIED, INCLUDING BUT NOT LIMITED TO THE WARRANTIES OF MERCHANTABILITY, FITNESS FOR A PARTICULAR PURPOSE AND NONINFRINGEMENT. IN NO EVENT SHALL THE AUTHORS OR COPYRIGHT HOLDERS BE LIABLE FOR ANY CLAIM, DAMAGES OR OTHER LIABILITY, WHETHER IN AN ACTION OF CONTRACT, TORT OR OTHERWISE, ARISING FROM, OUT OF OR IN CONNECTION WITH THE SOFTWARE OR THE USE OR OTHER DEALINGS IN THE SOFTWARE.

""""

- c-ares, located at deps/cares, is licensed as follows:

""""

Copyright (c) 2007 - 2018, Daniel Stenberg with many contributors, see AUTHORS file.

Copyright 1998 by the Massachusetts Institute of Technology.

Permission to use, copy, modify, and distribute this software and its documentation for any purpose and without fee is hereby granted, provided that the above copyright notice appear in all copies and that both that copyright notice and this permission notice appear in supporting documentation, and that the name of M.I.T. not be used in advertising or publicity pertaining to distribution of the software without specific, written prior permission. M.I.T. makes no representations about the suitability of this software for any purpose. It is provided "as is" without express or implied warranty.

""""

- cjs-module-lexer, located at deps/cjs-module-lexer, is licensed as follows:

""""

MIT License

-----

Copyright (C) 2018-2020 Guy Bedford

Permission is hereby granted, free of charge, to any person obtaining a copy of this software and associated documentation files (the "Software"), to deal in the Software without restriction, including without limitation the rights to use, copy, modify, merge, publish, distribute, sublicense, and/or sell copies of the Software, and to permit persons to whom the Software is furnished to do so, subject to the following conditions:

The above copyright notice and this permission notice shall be included in all copies or substantial portions of the Software.

THE SOFTWARE IS PROVIDED "AS IS", WITHOUT WARRANTY OF ANY KIND, EXPRESS OR IMPLIED, INCLUDING BUT NOT LIMITED TO THE WARRANTIES OF MERCHANTABILITY, FITNESS FOR A PARTICULAR PURPOSE AND

NONINFRINGEMENT. IN NO EVENT SHALL THE AUTHORS OR COPYRIGHT HOLDERS BE LIABLE FOR ANY CLAIM, DAMAGES OR OTHER LIABILITY, WHETHER IN AN ACTION OF CONTRACT, TORT OR OTHERWISE, ARISING FROM, OUT OF OR IN CONNECTION WITH THE SOFTWARE OR THE USE OR OTHER DEALINGS IN THE SOFTWARE.

""""

- ittapi, located at deps/v8/third\_party/ittapi, is licensed as follows:

""""

Copyright (c) 2019 Intel Corporation. All rights reserved.

Redistribution and use in source and binary forms, with or without modification, are permitted provided that the following conditions are met:

1. Redistributions of source code must retain the above copyright notice, this list of conditions and the following disclaimer.

2. Redistributions in binary form must reproduce the above copyright notice, this list of conditions and the following disclaimer in the documentation and/or other materials provided with the distribution.

3. Neither the name of the copyright holder nor the names of its contributors may be used to endorse or promote products derived from this software without specific prior written permission.

THIS SOFTWARE IS PROVIDED BY THE COPYRIGHT HOLDERS AND CONTRIBUTORS "AS IS" AND ANY EXPRESS OR IMPLIED WARRANTIES, INCLUDING, BUT NOT LIMITED TO, THE IMPLIED WARRANTIES OF MERCHANTABILITY AND FITNESS FOR A PARTICULAR PURPOSE ARE DISCLAIMED. IN NO EVENT SHALL THE COPYRIGHT HOLDER OR CONTRIBUTORS BE LIABLE FOR ANY DIRECT, INDIRECT, INCIDENTAL, SPECIAL, EXEMPLARY, OR CONSEQUENTIAL DAMAGES (INCLUDING, BUT NOT LIMITED TO, PROCUREMENT OF SUBSTITUTE GOODS OR SERVICES; LOSS OF USE, DATA, OR PROFITS; OR BUSINESS INTERRUPTION) HOWEVER CAUSED AND ON ANY THEORY OF LIABILITY, WHETHER IN CONTRACT, STRICT LIABILITY, OR TORT (INCLUDING NEGLIGENCE OR OTHERWISE) ARISING IN ANY WAY OUT OF THE USE OF THIS SOFTWARE, EVEN IF ADVISED OF THE POSSIBILITY OF SUCH DAMAGE.

""""

- ICU, located at deps/icu-small, is licensed as follows:

""""

UNICODE, INC. LICENSE AGREEMENT - DATA FILES AND SOFTWARE

See Terms of Use

for definitions of Unicode Inc.'s Data Files and Software.

NOTICE TO USER: Carefully read the following legal agreement.

BY DOWNLOADING, INSTALLING, COPYING OR OTHERWISE USING UNICODE INC.'S DATA FILES ("DATA FILES"), AND/OR SOFTWARE ("SOFTWARE"), YOU UNEQUIVOCALLY ACCEPT, AND AGREE TO BE BOUND BY, ALL OF THE TERMS AND CONDITIONS OF THIS AGREEMENT.

IF YOU DO NOT AGREE, DO NOT DOWNLOAD, INSTALL, COPY, DISTRIBUTE OR USE THE DATA FILES OR SOFTWARE.

COPYRIGHT AND PERMISSION NOTICE

Copyright © 1991-2022 Unicode, Inc. All rights reserved.

Distributed under the Terms of Use in <https://www.unicode.org/copyright.html>.

Permission is hereby granted, free of charge, to any person obtaining a copy of the Unicode data files and any associated documentation (the "Data Files") or Unicode software and any associated documentation (the "Software") to deal in the Data Files or Software without restriction, including without limitation the rights to use, copy, modify, merge, publish, distribute, and/or sell copies of the Data Files or Software, and to permit persons to whom the Data Files or Software are furnished to do so, provided that either (a) this copyright and permission notice appear with all copies of the Data Files or Software, or

(b) this copyright and permission notice appear in associated Documentation.

THE DATA FILES AND SOFTWARE ARE PROVIDED "AS IS", WITHOUT WARRANTY OF ANY KIND, EXPRESS OR IMPLIED, INCLUDING BUT NOT LIMITED TO THE WARRANTIES OF MERCHANTABILITY, FITNESS FOR A PARTICULAR PURPOSE AND NONINFRINGEMENT OF THIRD PARTY RIGHTS.

IN NO EVENT SHALL THE COPYRIGHT HOLDER OR HOLDERS INCLUDED IN THIS NOTICE BE LIABLE FOR ANY CLAIM, OR ANY SPECIAL INDIRECT OR CONSEQUENTIAL DAMAGES, OR ANY DAMAGES WHATSOEVER RESULTING FROM LOSS OF USE, DATA OR PROFITS, WHETHER IN AN ACTION OF CONTRACT, NEGLIGENCE OR OTHER TORTIOUS ACTION, ARISING OUT OF OR IN CONNECTION WITH THE USE OR PERFORMANCE OF THE DATA FILES OR SOFTWARE.

Except as contained in this notice, the name of a copyright holder shall not be used in advertising or otherwise to promote the sale, use or other dealings in these Data Files or Software without prior written authorization of the copyright holder.

-----  
Third-Party Software Licenses

This section contains third-party software notices and/or additional terms for licensed third-party software components included within ICU libraries.

-----  
ICU License - ICU 1.8.1 to ICU 57.1

COPYRIGHT AND PERMISSION NOTICE

Copyright (c) 1995-2016 International Business Machines Corporation and others  
All rights reserved.

Permission is hereby granted, free of charge, to any person obtaining a copy of this software and associated documentation files (the "Software"), to deal in the Software without restriction, including without limitation the rights to use, copy, modify, merge, publish, distribute, and/or sell copies of the Software, and to permit persons to whom the Software is furnished to do so, provided that the above copyright notice(s) and this permission notice appear in all copies of the Software and that both the above copyright notice(s) and this permission notice appear in supporting documentation.

THE SOFTWARE IS PROVIDED "AS IS", WITHOUT WARRANTY OF ANY KIND, EXPRESS OR IMPLIED, INCLUDING BUT NOT LIMITED TO THE WARRANTIES OF MERCHANTABILITY, FITNESS FOR A PARTICULAR PURPOSE AND NONINFRINGEMENT OF THIRD PARTY RIGHTS. IN NO EVENT SHALL THE COPYRIGHT HOLDER OR HOLDERS INCLUDED IN THIS NOTICE BE LIABLE FOR ANY CLAIM, OR ANY SPECIAL INDIRECT OR CONSEQUENTIAL DAMAGES, OR ANY DAMAGES WHATSOEVER RESULTING FROM LOSS OF USE, DATA OR PROFITS, WHETHER IN AN ACTION OF CONTRACT, NEGLIGENCE OR OTHER TORTIOUS ACTION, ARISING OUT OF OR IN CONNECTION WITH THE USE OR PERFORMANCE OF THIS SOFTWARE.

Except as contained in this notice, the name of a copyright holder shall not be used in advertising or otherwise to promote the sale, use

or other dealings in this Software without prior written authorization of the copyright holder.

All trademarks and registered trademarks mentioned herein are the property of their respective owners.

-----  
Chinese/Japanese Word Break Dictionary Data (cjdict.txt)

```
# The Google Chrome software developed by Google is licensed under
# the BSD license. Other software included in this distribution is
# provided under other licenses, as set forth below.
#
# The BSD License
# http://opensource.org/licenses/bsd-license.php
# Copyright (C) 2006-2008, Google Inc.
#
# All rights reserved.
#
# Redistribution and use in source and binary forms, with or without
# modification, are permitted provided that the following conditions are met:
#
# Redistributions of source code must retain the above copyright notice,
# this list of conditions and the following disclaimer.
# Redistributions in binary form must reproduce the above
# copyright notice, this list of conditions and the following
# disclaimer in the documentation and/or other materials provided with
# the distribution.
# Neither the name of Google Inc. nor the names of its
# contributors may be used to endorse or promote products derived from
# this software without specific prior written permission.
#
#
# THIS SOFTWARE IS PROVIDED BY THE COPYRIGHT HOLDERS AND
# CONTRIBUTORS "AS IS" AND ANY EXPRESS OR IMPLIED WARRANTIES,
# INCLUDING, BUT NOT LIMITED TO, THE IMPLIED WARRANTIES OF
# MERCHANTABILITY AND FITNESS FOR A PARTICULAR PURPOSE ARE
# DISCLAIMED. IN NO EVENT SHALL THE COPYRIGHT OWNER OR CONTRIBUTORS BE
# LIABLE FOR ANY DIRECT, INDIRECT, INCIDENTAL, SPECIAL, EXEMPLARY, OR
# CONSEQUENTIAL DAMAGES (INCLUDING, BUT NOT LIMITED TO, PROCUREMENT OF
# SUBSTITUTE GOODS OR SERVICES; LOSS OF USE, DATA, OR PROFITS; OR
# BUSINESS INTERRUPTION) HOWEVER CAUSED AND ON ANY THEORY OF
# LIABILITY, WHETHER IN CONTRACT, STRICT LIABILITY, OR TORT (INCLUDING
# NEGLIGENCE OR OTHERWISE) ARISING IN ANY WAY OUT OF THE USE OF THIS
# SOFTWARE, EVEN IF ADVISED OF THE POSSIBILITY OF SUCH DAMAGE.
#
#
# The word list in cjdict.txt are generated by combining three word lists
# listed below with further processing for compound word breaking. The
# frequency is generated with an iterative training against Google web
# corpora.
#
# * Libtabe (Chinese)
# - https://sourceforge.net/project/?group\_id=1519
```

```

# - Its license terms and conditions are shown below.
#
# * IPADIC (Japanese)
# - http://chasen.aist-nara.ac.jp/chasen/distribution.html
# - Its license terms and conditions are shown below.
#
# -----COPYING.libtabe ---- BEGIN-----
#
# /*
# * Copyright (c) 1999 TaBE Project.
# * Copyright (c) 1999 Pai-Hsiang Hsiao.
# * All rights reserved.
# *
# * Redistribution and use in source and binary forms, with or without
# * modification, are permitted provided that the following conditions
# * are met:
# *
# * . Redistributions of source code must retain the above copyright
# * notice, this list of conditions and the following disclaimer.
# * . Redistributions in binary form must reproduce the above copyright
# * notice, this list of conditions and the following disclaimer in
# * the documentation and/or other materials provided with the
# * distribution.
# * . Neither the name of the TaBE Project nor the names of its
# * contributors may be used to endorse or promote products derived
# * from this software without specific prior written permission.
# *
# * THIS SOFTWARE IS PROVIDED BY THE COPYRIGHT HOLDERS AND CONTRIBUTORS
# * "AS IS" AND ANY EXPRESS OR IMPLIED WARRANTIES, INCLUDING, BUT NOT
# * LIMITED TO, THE IMPLIED WARRANTIES OF MERCHANTABILITY AND FITNESS
# * FOR A PARTICULAR PURPOSE ARE DISCLAIMED. IN NO EVENT SHALL THE
# * REGENTS OR CONTRIBUTORS BE LIABLE FOR ANY DIRECT, INDIRECT,
# * INCIDENTAL, SPECIAL, EXEMPLARY, OR CONSEQUENTIAL DAMAGES
# * (INCLUDING, BUT NOT LIMITED TO, PROCUREMENT OF SUBSTITUTE GOODS OR
# * SERVICES; LOSS OF USE, DATA, OR PROFITS; OR BUSINESS INTERRUPTION)
# * HOWEVER CAUSED AND ON ANY THEORY OF LIABILITY, WHETHER IN CONTRACT,
# * STRICT LIABILITY, OR TORT (INCLUDING NEGLIGENCE OR OTHERWISE)
# * ARISING IN ANY WAY OUT OF THE USE OF THIS SOFTWARE, EVEN IF ADVISED
# * OF THE POSSIBILITY OF SUCH DAMAGE.
# */
#
# /*
# * Copyright (c) 1999 Computer Systems and Communication Lab,
# * Institute of Information Science, Academia
# * Sinica. All rights reserved.
# *
# * Redistribution and use in source and binary forms, with or without
# * modification, are permitted provided that the following conditions
# * are met:
# *
# * . Redistributions of source code must retain the above copyright
# * notice, this list of conditions and the following disclaimer.
# * . Redistributions in binary form must reproduce the above copyright

```

```

# * notice, this list of conditions and the following disclaimer in
# * the documentation and/or other materials provided with the
# * distribution.
# * . Neither the name of the Computer Systems and Communication Lab
# * nor the names of its contributors may be used to endorse or
# * promote products derived from this software without specific
# * prior written permission.
# *
# * THIS SOFTWARE IS PROVIDED BY THE COPYRIGHT HOLDERS AND CONTRIBUTORS
# * "AS IS" AND ANY EXPRESS OR IMPLIED WARRANTIES, INCLUDING, BUT NOT
# * LIMITED TO, THE IMPLIED WARRANTIES OF MERCHANTABILITY AND FITNESS
# * FOR A PARTICULAR PURPOSE ARE DISCLAIMED. IN NO EVENT SHALL THE
# * REGENTS OR CONTRIBUTORS BE LIABLE FOR ANY DIRECT, INDIRECT,
# * INCIDENTAL, SPECIAL, EXEMPLARY, OR CONSEQUENTIAL DAMAGES
# * (INCLUDING, BUT NOT LIMITED TO, PROCUREMENT OF SUBSTITUTE GOODS OR
# * SERVICES; LOSS OF USE, DATA, OR PROFITS; OR BUSINESS INTERRUPTION)
# * HOWEVER CAUSED AND ON ANY THEORY OF LIABILITY, WHETHER IN CONTRACT,
# * STRICT LIABILITY, OR TORT (INCLUDING NEGLIGENCE OR OTHERWISE)
# * ARISING IN ANY WAY OUT OF THE USE OF THIS SOFTWARE, EVEN IF ADVISED
# * OF THE POSSIBILITY OF SUCH DAMAGE.
# */
#
# Copyright 1996 Chih-Hao Tsai @ Beckman Institute,
#   University of Illinois
# c-tsai4@uiuc.edu http://casper.beckman.uiuc.edu/~c-tsai4
#
# -----COPYING.libtabe-----END-----
#
# -----COPYING.ipadic-----BEGIN-----
#
# Copyright 2000, 2001, 2002, 2003 Nara Institute of Science
# and Technology. All Rights Reserved.
#
# Use, reproduction, and distribution of this software is permitted.
# Any copy of this software, whether in its original form or modified,
# must include both the above copyright notice and the following
# paragraphs.
#
# Nara Institute of Science and Technology (NAIST),
# the copyright holders, disclaims all warranties with regard to this
# software, including all implied warranties of merchantability and
# fitness, in no event shall NAIST be liable for
# any special, indirect or consequential damages or any damages
# whatsoever resulting from loss of use, data or profits, whether in an
# action of contract, negligence or other tortious action, arising out
# of or in connection with the use or performance of this software.
#
# A large portion of the dictionary entries
# originate from ICOT Free Software. The following conditions for ICOT
# Free Software applies to the current dictionary as well.
#
# Each User may also freely distribute the Program, whether in its

```

```

# original form or modified, to any third party or parties, PROVIDED
# that the provisions of Section 3 ("NO WARRANTY") will ALWAYS appear
# on, or be attached to, the Program, which is distributed substantially
# in the same form as set out herein and that such intended
# distribution, if actually made, will neither violate or otherwise
# contravene any of the laws and regulations of the countries having
# jurisdiction over the User or the intended distribution itself.
#
# NO WARRANTY
#
# The program was produced on an experimental basis in the course of the
# research and development conducted during the project and is provided
# to users as so produced on an experimental basis. Accordingly, the
# program is provided without any warranty whatsoever, whether express,
# implied, statutory or otherwise. The term "warranty" used herein
# includes, but is not limited to, any warranty of the quality,
# performance, merchantability and fitness for a particular purpose of
# the program and the nonexistence of any infringement or violation of
# any right of any third party.
#
# Each user of the program will agree and understand, and be deemed to
# have agreed and understood, that there is no warranty whatsoever for
# the program and, accordingly, the entire risk arising from or
# otherwise connected with the program is assumed by the user.
#
# Therefore, neither ICOT, the copyright holder, or any other
# organization that participated in or was otherwise related to the
# development of the program and their respective officials, directors,
# officers and other employees shall be held liable for any and all
# damages, including, without limitation, general, special, incidental
# and consequential damages, arising out of or otherwise in connection
# with the use or inability to use the program or any product, material
# or result produced or otherwise obtained by using the program,
# regardless of whether they have been advised of, or otherwise had
# knowledge of, the possibility of such damages at any time during the
# project or thereafter. Each user will be deemed to have agreed to the
# foregoing by his or her commencement of use of the program. The term
# "use" as used herein includes, but is not limited to, the use,
# modification, copying and distribution of the program and the
# production of secondary products from the program.
#
# In the case where the program, whether in its original form or
# modified, was distributed or delivered to or received by a user from
# any person, organization or entity other than ICOT, unless it makes or
# grants independently of ICOT any specific warranty to the user in
# writing, such person, organization or entity, will also be exempted
# from and not be held liable to the user for any such damages as noted
# above as far as the program is concerned.
#
# -----COPYING.ipadic-----END-----

```

-----  
Lao Word Break Dictionary Data (laodict.txt)

```
# Copyright (C) 2016 and later: Unicode, Inc. and others.
# License & terms of use: http://www.unicode.org/copyright.html
# Copyright (c) 2015 International Business Machines Corporation
# and others. All Rights Reserved.
#
# Project: https://github.com/rober42539/lao-dictionary
# Dictionary: https://github.com/rober42539/lao-dictionary/laodict.txt
# License: https://github.com/rober42539/lao-dictionary/LICENSE.txt
# (copied below)
#
# This file is derived from the above dictionary version of Nov 22, 2020
# -----
# Copyright (C) 2013 Brian Eugene Wilson, Robert Martin Campbell.
# All rights reserved.
#
# Redistribution and use in source and binary forms, with or without
# modification, are permitted provided that the following conditions are met:
#
# Redistributions of source code must retain the above copyright notice, this
# list of conditions and the following disclaimer. Redistributions in binary
# form must reproduce the above copyright notice, this list of conditions and
# the following disclaimer in the documentation and/or other materials
# provided with the distribution.
#
# THIS SOFTWARE IS PROVIDED BY THE COPYRIGHT HOLDERS AND CONTRIBUTORS
# "AS IS" AND ANY EXPRESS OR IMPLIED WARRANTIES, INCLUDING, BUT NOT
# LIMITED TO, THE IMPLIED WARRANTIES OF MERCHANTABILITY AND FITNESS
# FOR A PARTICULAR PURPOSE ARE DISCLAIMED. IN NO EVENT SHALL THE
# COPYRIGHT HOLDER OR CONTRIBUTORS BE LIABLE FOR ANY DIRECT,
# INDIRECT, INCIDENTAL, SPECIAL, EXEMPLARY, OR CONSEQUENTIAL DAMAGES
# (INCLUDING, BUT NOT LIMITED TO, PROCUREMENT OF SUBSTITUTE GOODS OR
# SERVICES; LOSS OF USE, DATA, OR PROFITS; OR BUSINESS INTERRUPTION)
# HOWEVER CAUSED AND ON ANY THEORY OF LIABILITY, WHETHER IN CONTRACT,
# STRICT LIABILITY, OR TORT (INCLUDING NEGLIGENCE OR OTHERWISE)
# ARISING IN ANY WAY OUT OF THE USE OF THIS SOFTWARE, EVEN IF ADVISED
# OF THE POSSIBILITY OF SUCH DAMAGE.
# -----
```

-----  
 Burmese Word Break Dictionary Data (burmesedict.txt)

```
# Copyright (c) 2014 International Business Machines Corporation
# and others. All Rights Reserved.
#
# This list is part of a project hosted at:
# github.com/kanyawtech/myanmar-karen-word-lists
#
# -----
# Copyright (c) 2013, LeRoy Benjamin Sharon
# All rights reserved.
#
# Redistribution and use in source and binary forms, with or without
# modification, are permitted provided that the following conditions
# are met: Redistributions of source code must retain the above
```



```
# copyright notice, this list of conditions and the following
# disclaimer. Redistributions in binary form must reproduce the
# above copyright notice, this list of conditions and the following
# disclaimer in the documentation and/or other materials provided
# with the distribution.
#
# Neither the name Myanmar Karen Word Lists, nor the names of its
# contributors may be used to endorse or promote products derived
# from this software without specific prior written permission.
#
# THIS SOFTWARE IS PROVIDED BY THE COPYRIGHT HOLDERS AND
# CONTRIBUTORS "AS IS" AND ANY EXPRESS OR IMPLIED WARRANTIES,
# INCLUDING, BUT NOT LIMITED TO, THE IMPLIED WARRANTIES OF
# MERCHANTABILITY AND FITNESS FOR A PARTICULAR PURPOSE ARE
# DISCLAIMED. IN NO EVENT SHALL THE COPYRIGHT HOLDER OR CONTRIBUTORS
# BE LIABLE FOR ANY DIRECT, INDIRECT, INCIDENTAL, SPECIAL,
# EXEMPLARY, OR CONSEQUENTIAL DAMAGES (INCLUDING, BUT NOT LIMITED
# TO, PROCUREMENT OF SUBSTITUTE GOODS OR SERVICES; LOSS OF USE,
# DATA, OR PROFITS; OR BUSINESS INTERRUPTION) HOWEVER CAUSED AND ON
# ANY THEORY OF LIABILITY, WHETHER IN CONTRACT, STRICT LIABILITY, OR
# TORT (INCLUDING NEGLIGENCE OR OTHERWISE) ARISING IN ANY WAY OUT OF
# THE USE OF THIS SOFTWARE, EVEN IF ADVISED OF THE POSSIBILITY OF
# SUCH DAMAGE.
# -----
```

-----

Time Zone Database

ICU uses the public domain data and code derived from Time Zone Database for its time zone support. The ownership of the TZ database is explained in BCP 175: Procedure for Maintaining the Time Zone Database section 7.

```
# 7. Database Ownership
#
# The TZ database itself is not an IETF Contribution or an IETF
# document. Rather it is a pre-existing and regularly updated work
# that is in the public domain, and is intended to remain in the
# public domain. Therefore, BCPs 78 [RFC5378] and 79 [RFC3979] do
# not apply to the TZ Database or contributions that individuals make
# to it. Should any claims be made and substantiated against the TZ
# Database, the organization that is providing the IANA
# Considerations defined in this RFC, under the memorandum of
# understanding with the IETF, currently ICANN, may act in accordance
# with all competent court orders. No ownership claims will be made
# by ICANN or the IETF Trust on the database or the code. Any person
# making a contribution to the database or code waives all rights to
# future claims in that contribution or in the TZ Database.
```

-----

Google double-conversion

Copyright 2006-2011, the V8 project authors. All rights reserved.  
Redistribution and use in source and binary forms, with or without

modification, are permitted provided that the following conditions are met:

- \* Redistributions of source code must retain the above copyright notice, this list of conditions and the following disclaimer.
- \* Redistributions in binary form must reproduce the above copyright notice, this list of conditions and the following disclaimer in the documentation and/or other materials provided with the distribution.
- \* Neither the name of Google Inc. nor the names of its contributors may be used to endorse or promote products derived from this software without specific prior written permission.

THIS SOFTWARE IS PROVIDED BY THE COPYRIGHT HOLDERS AND CONTRIBUTORS "AS IS" AND ANY EXPRESS OR IMPLIED WARRANTIES, INCLUDING, BUT NOT LIMITED TO, THE IMPLIED WARRANTIES OF MERCHANTABILITY AND FITNESS FOR A PARTICULAR PURPOSE ARE DISCLAIMED. IN NO EVENT SHALL THE COPYRIGHT OWNER OR CONTRIBUTORS BE LIABLE FOR ANY DIRECT, INDIRECT, INCIDENTAL, SPECIAL, EXEMPLARY, OR CONSEQUENTIAL DAMAGES (INCLUDING, BUT NOT LIMITED TO, PROCUREMENT OF SUBSTITUTE GOODS OR SERVICES; LOSS OF USE, DATA, OR PROFITS; OR BUSINESS INTERRUPTION) HOWEVER CAUSED AND ON ANY THEORY OF LIABILITY, WHETHER IN CONTRACT, STRICT LIABILITY, OR TORT (INCLUDING NEGLIGENCE OR OTHERWISE) ARISING IN ANY WAY OUT OF THE USE OF THIS SOFTWARE, EVEN IF ADVISED OF THE POSSIBILITY OF SUCH DAMAGE.

-----  
 File: alocal.m4 (only for ICU4C)

Section: pkg.m4 - Macros to locate and utilise pkg-config.

Copyright © 2004 Scott James Remnant .

Copyright © 2012-2015 Dan Nicholson

This program is free software; you can redistribute it and/or modify it under the terms of the GNU General Public License as published by the Free Software Foundation; either version 2 of the License, or (at your option) any later version.

This program is distributed in the hope that it will be useful, but WITHOUT ANY WARRANTY; without even the implied warranty of MERCHANTABILITY or FITNESS FOR A PARTICULAR PURPOSE. See the GNU General Public License for more details.

You should have received a copy of the GNU General Public License along with this program; if not, write to the Free Software Foundation, Inc., 59 Temple Place - Suite 330, Boston, MA 02111-1307, USA.

As a special exception to the GNU General Public License, if you distribute this file as part of a program that contains a configuration script generated by Autoconf, you may include it under the same distribution terms that you use for the rest of that program.

(The condition for the exception is fulfilled because ICU4C includes a configuration script generated by Autoconf, namely the `configure` script.)

-----  
 File: config.guess (only for ICU4C)

This file is free software; you can redistribute it and/or modify it under the terms of the GNU General Public License as published by the Free Software Foundation; either version 3 of the License, or (at your option) any later version.

This program is distributed in the hope that it will be useful, but WITHOUT ANY WARRANTY; without even the implied warranty of MERCHANTABILITY or FITNESS FOR A PARTICULAR PURPOSE. See the GNU General Public License for more details.

You should have received a copy of the GNU General Public License along with this program; if not, see .

As a special exception to the GNU General Public License, if you distribute this file as part of a program that contains a configuration script generated by Autoconf, you may include it under the same distribution terms that you use for the rest of that program. This Exception is an additional permission under section 7 of the GNU General Public License, version 3 ("GPLv3").

(The condition for the exception is fulfilled because ICU4C includes a configuration script generated by Autoconf, namely the `configure` script.)

-----  
 File: install-sh (only for ICU4C)

Copyright 1991 by the Massachusetts Institute of Technology

Permission to use, copy, modify, distribute, and sell this software and its documentation for any purpose is hereby granted without fee, provided that the above copyright notice appear in all copies and that both that copyright notice and this permission notice appear in supporting documentation, and that the name of M.I.T. not be used in advertising or publicity pertaining to distribution of the software without specific, written prior permission. M.I.T. makes no representations about the suitability of this software for any purpose. It is provided "as is" without express or implied warranty.

""""

- libuv, located at deps/uv, is licensed as follows:

""""

libuv is licensed for use as follows:

====

Copyright (c) 2015-present libuv project contributors.

Permission is hereby granted, free of charge, to any person obtaining a copy of this software and associated documentation files (the "Software"), to deal in the Software without restriction, including without limitation the rights to use, copy, modify, merge, publish, distribute, sublicense, and/or sell copies of the Software, and to permit persons to whom the Software is furnished to do so, subject to the following conditions:

The above copyright notice and this permission notice shall be included in all copies or substantial portions of the Software.

THE SOFTWARE IS PROVIDED "AS IS", WITHOUT WARRANTY OF ANY KIND, EXPRESS OR IMPLIED, INCLUDING BUT NOT LIMITED TO THE WARRANTIES OF MERCHANTABILITY, FITNESS FOR A PARTICULAR PURPOSE AND NONINFRINGEMENT. IN NO EVENT SHALL THE AUTHORS OR COPYRIGHT HOLDERS BE LIABLE FOR ANY CLAIM, DAMAGES OR OTHER LIABILITY, WHETHER IN AN ACTION OF CONTRACT, TORT OR OTHERWISE, ARISING FROM, OUT OF OR IN CONNECTION WITH THE SOFTWARE OR THE USE OR OTHER DEALINGS IN THE SOFTWARE.

====

This license applies to parts of libuv originating from the <https://github.com/joyent/libuv> repository:

====

Copyright Joyent, Inc. and other Node contributors. All rights reserved. Permission is hereby granted, free of charge, to any person obtaining a copy of this software and associated documentation files (the "Software"), to deal in the Software without restriction, including without limitation the rights to use, copy, modify, merge, publish, distribute, sublicense, and/or sell copies of the Software, and to permit persons to whom the Software is furnished to do so, subject to the following conditions:

The above copyright notice and this permission notice shall be included in all copies or substantial portions of the Software.

THE SOFTWARE IS PROVIDED "AS IS", WITHOUT WARRANTY OF ANY KIND, EXPRESS OR IMPLIED, INCLUDING BUT NOT LIMITED TO THE WARRANTIES OF MERCHANTABILITY, FITNESS FOR A PARTICULAR PURPOSE AND NONINFRINGEMENT. IN NO EVENT SHALL THE AUTHORS OR COPYRIGHT HOLDERS BE LIABLE FOR ANY CLAIM, DAMAGES OR OTHER LIABILITY, WHETHER IN AN ACTION OF CONTRACT, TORT OR OTHERWISE, ARISING FROM, OUT OF OR IN CONNECTION WITH THE SOFTWARE OR THE USE OR OTHER DEALINGS IN THE SOFTWARE.

====

This license applies to all parts of libuv that are not externally maintained libraries.

The externally maintained libraries used by libuv are:

- tree.h (from FreeBSD), copyright Niels Provos. Two clause BSD license.
- inet\_pton and inet\_ntop implementations, contained in src/inet.c, are copyright the Internet Systems Consortium, Inc., and licensed under the ISC license.
- stdint-msvc2008.h (from msinttypes), copyright Alexander Chemeris. Three clause BSD license.
- pthread-fixes.c, copyright Google Inc. and Sony Mobile Communications AB. Three clause BSD license.

""""

- llhttp, located at deps/llhttp, is licensed as follows:

""""

This software is licensed under the MIT License.

Copyright Fedor Indutny, 2018.

Permission is hereby granted, free of charge, to any person obtaining a copy of this software and associated documentation files (the "Software"), to deal in the Software without restriction, including without limitation the rights to use, copy, modify, merge, publish, distribute, sublicense, and/or sell copies of the Software, and to permit persons to whom the Software is furnished to do so, subject to the following conditions:

The above copyright notice and this permission notice shall be included in all copies or substantial portions of the Software.

THE SOFTWARE IS PROVIDED "AS IS", WITHOUT WARRANTY OF ANY KIND, EXPRESS OR IMPLIED, INCLUDING BUT NOT LIMITED TO THE WARRANTIES OF MERCHANTABILITY, FITNESS FOR A PARTICULAR PURPOSE AND NONINFRINGEMENT. IN NO EVENT SHALL THE AUTHORS OR COPYRIGHT HOLDERS BE LIABLE FOR ANY CLAIM, DAMAGES OR OTHER LIABILITY, WHETHER IN AN ACTION OF CONTRACT, TORT OR OTHERWISE, ARISING FROM, OUT OF OR IN CONNECTION WITH THE SOFTWARE OR THE USE OR OTHER DEALINGS IN THE SOFTWARE.

""""

- corepack, located at deps/corepack, is licensed as follows:

""""

**\*\*Copyright © Corepack contributors\*\***

Permission is hereby granted, free of charge, to any person obtaining a copy of this software and associated documentation files (the "Software"), to deal in the Software without restriction, including without limitation the rights to use, copy, modify, merge, publish, distribute, sublicense, and/or sell copies of the Software, and to permit persons to whom the Software is furnished to do so, subject to the following conditions:

The above copyright notice and this permission notice shall be included in all copies or substantial portions of the Software.

THE SOFTWARE IS PROVIDED "AS IS", WITHOUT WARRANTY OF ANY KIND, EXPRESS OR IMPLIED, INCLUDING BUT NOT LIMITED TO THE WARRANTIES OF MERCHANTABILITY, FITNESS FOR A PARTICULAR PURPOSE AND NONINFRINGEMENT. IN NO EVENT SHALL THE AUTHORS OR COPYRIGHT HOLDERS BE LIABLE FOR ANY CLAIM, DAMAGES OR OTHER LIABILITY, WHETHER IN AN ACTION OF CONTRACT, TORT OR OTHERWISE, ARISING FROM, OUT OF OR IN CONNECTION WITH THE SOFTWARE OR THE USE OR OTHER DEALINGS IN THE SOFTWARE.

""""

- undici, located at deps/undici, is licensed as follows:

""""

MIT License

Copyright (c) Matteo Collina and Undici contributors

Permission is hereby granted, free of charge, to any person obtaining a copy of this software and associated documentation files (the "Software"), to deal in the Software without restriction, including without limitation the rights to use, copy, modify, merge, publish, distribute, sublicense, and/or sell copies of the Software, and to permit persons to whom the Software is furnished to do so, subject to the following conditions:

The above copyright notice and this permission notice shall be included in all copies or substantial portions of the Software.

THE SOFTWARE IS PROVIDED "AS IS", WITHOUT WARRANTY OF ANY KIND, EXPRESS OR IMPLIED, INCLUDING BUT NOT LIMITED TO THE WARRANTIES OF MERCHANTABILITY,

FITNESS FOR A PARTICULAR PURPOSE AND NONINFRINGEMENT. IN NO EVENT SHALL THE AUTHORS OR COPYRIGHT HOLDERS BE LIABLE FOR ANY CLAIM, DAMAGES OR OTHER LIABILITY, WHETHER IN AN ACTION OF CONTRACT, TORT OR OTHERWISE, ARISING FROM, OUT OF OR IN CONNECTION WITH THE SOFTWARE OR THE USE OR OTHER DEALINGS IN THE SOFTWARE.

""

- postject, located at test/fixtures/postject-copy, is licensed as follows:

""

Postject is licensed for use as follows:

""

MIT License

Copyright (c) 2022 Postman, Inc

Permission is hereby granted, free of charge, to any person obtaining a copy of this software and associated documentation files (the "Software"), to deal in the Software without restriction, including without limitation the rights to use, copy, modify, merge, publish, distribute, sublicense, and/or sell copies of the Software, and to permit persons to whom the Software is furnished to do so, subject to the following conditions:

The above copyright notice and this permission notice shall be included in all copies or substantial portions of the Software.

THE SOFTWARE IS PROVIDED "AS IS", WITHOUT WARRANTY OF ANY KIND, EXPRESS OR IMPLIED, INCLUDING BUT NOT LIMITED TO THE WARRANTIES OF MERCHANTABILITY, FITNESS FOR A PARTICULAR PURPOSE AND NONINFRINGEMENT. IN NO EVENT SHALL THE AUTHORS OR COPYRIGHT HOLDERS BE LIABLE FOR ANY CLAIM, DAMAGES OR OTHER LIABILITY, WHETHER IN AN ACTION OF CONTRACT, TORT OR OTHERWISE, ARISING FROM, OUT OF OR IN CONNECTION WITH THE SOFTWARE OR THE USE OR OTHER DEALINGS IN THE SOFTWARE.

""

The Postject license applies to all parts of Postject that are not externally maintained libraries.

The externally maintained libraries used by Postject are:

- LIEF, located at vendor/LIEF, is licensed as follows:

""

Apache License  
Version 2.0, January 2004  
<http://www.apache.org/licenses/>

## TERMS AND CONDITIONS FOR USE, REPRODUCTION, AND DISTRIBUTION

### 1. Definitions.

"License" shall mean the terms and conditions for use, reproduction, and distribution as defined by Sections 1 through 9 of this document.

"Licensor" shall mean the copyright owner or entity authorized by the copyright owner that is granting the License.

"Legal Entity" shall mean the union of the acting entity and all other entities that control, are controlled by, or are under common control with that entity. For the purposes of this definition, "control" means (i) the power, direct or indirect, to cause the

direction or management of such entity, whether by contract or otherwise, or (ii) ownership of fifty percent (50%) or more of the outstanding shares, or (iii) beneficial ownership of such entity.

"You" (or "Your") shall mean an individual or Legal Entity exercising permissions granted by this License.

"Source" form shall mean the preferred form for making modifications, including but not limited to software source code, documentation source, and configuration files.

"Object" form shall mean any form resulting from mechanical transformation or translation of a Source form, including but not limited to compiled object code, generated documentation, and conversions to other media types.

"Work" shall mean the work of authorship, whether in Source or Object form, made available under the License, as indicated by a copyright notice that is included in or attached to the work (an example is provided in the Appendix below).

"Derivative Works" shall mean any work, whether in Source or Object form, that is based on (or derived from) the Work and for which the editorial revisions, annotations, elaborations, or other modifications represent, as a whole, an original work of authorship. For the purposes of this License, Derivative Works shall not include works that remain separable from, or merely link (or bind by name) to the interfaces of, the Work and Derivative Works thereof.

"Contribution" shall mean any work of authorship, including the original version of the Work and any modifications or additions to that Work or Derivative Works thereof, that is intentionally submitted to Licensor for inclusion in the Work by the copyright owner or by an individual or Legal Entity authorized to submit on behalf of the copyright owner. For the purposes of this definition, "submitted" means any form of electronic, verbal, or written communication sent to the Licensor or its representatives, including but not limited to communication on electronic mailing lists, source code control systems, and issue tracking systems that are managed by, or on behalf of, the Licensor for the purpose of discussing and improving the Work, but excluding communication that is conspicuously marked or otherwise designated in writing by the copyright owner as "Not a Contribution."

"Contributor" shall mean Licensor and any individual or Legal Entity on behalf of whom a Contribution has been received by Licensor and subsequently incorporated within the Work.

2. Grant of Copyright License. Subject to the terms and conditions of this License, each Contributor hereby grants to You a perpetual, worldwide, non-exclusive, no-charge, royalty-free, irrevocable copyright license to reproduce, prepare Derivative Works of, publicly display, publicly perform, sublicense, and distribute the Work and such Derivative Works in Source or Object form.
3. Grant of Patent License. Subject to the terms and conditions of this License, each Contributor hereby grants to You a perpetual, worldwide, non-exclusive, no-charge, royalty-free, irrevocable (except as stated in this section) patent license to make, have made,

use, offer to sell, sell, import, and otherwise transfer the Work, where such license applies only to those patent claims licensable by such Contributor that are necessarily infringed by their Contribution(s) alone or by combination of their Contribution(s) with the Work to which such Contribution(s) was submitted. If You institute patent litigation against any entity (including a cross-claim or counterclaim in a lawsuit) alleging that the Work or a Contribution incorporated within the Work constitutes direct or contributory patent infringement, then any patent licenses granted to You under this License for that Work shall terminate as of the date such litigation is filed.

4. Redistribution. You may reproduce and distribute copies of the Work or Derivative Works thereof in any medium, with or without modifications, and in Source or Object form, provided that You meet the following conditions:
  - (a) You must give any other recipients of the Work or Derivative Works a copy of this License; and
  - (b) You must cause any modified files to carry prominent notices stating that You changed the files; and
  - (c) You must retain, in the Source form of any Derivative Works that You distribute, all copyright, patent, trademark, and attribution notices from the Source form of the Work, excluding those notices that do not pertain to any part of the Derivative Works; and
  - (d) If the Work includes a "NOTICE" text file as part of its distribution, then any Derivative Works that You distribute must include a readable copy of the attribution notices contained within such NOTICE file, excluding those notices that do not pertain to any part of the Derivative Works, in at least one of the following places: within a NOTICE text file distributed as part of the Derivative Works; within the Source form or documentation, if provided along with the Derivative Works; or, within a display generated by the Derivative Works, if and wherever such third-party notices normally appear. The contents of the NOTICE file are for informational purposes only and do not modify the License. You may add Your own attribution notices within Derivative Works that You distribute, alongside or as an addendum to the NOTICE text from the Work, provided that such additional attribution notices cannot be construed as modifying the License.

You may add Your own copyright statement to Your modifications and may provide additional or different license terms and conditions for use, reproduction, or distribution of Your modifications, or for any such Derivative Works as a whole, provided Your use, reproduction, and distribution of the Work otherwise complies with the conditions stated in this License.

5. Submission of Contributions. Unless You explicitly state otherwise, any Contribution intentionally submitted for inclusion in the Work by You to the Licensor shall be under the terms and conditions of this License, without any additional terms or conditions.



Notwithstanding the above, nothing herein shall supersede or modify the terms of any separate license agreement you may have executed with Licensor regarding such Contributions.

6. Trademarks. This License does not grant permission to use the trade names, trademarks, service marks, or product names of the Licensor, except as required for reasonable and customary use in describing the origin of the Work and reproducing the content of the NOTICE file.
7. Disclaimer of Warranty. Unless required by applicable law or agreed to in writing, Licensor provides the Work (and each Contributor provides its Contributions) on an "AS IS" BASIS, WITHOUT WARRANTIES OR CONDITIONS OF ANY KIND, either express or implied, including, without limitation, any warranties or conditions of TITLE, NON-INFRINGEMENT, MERCHANTABILITY, or FITNESS FOR A PARTICULAR PURPOSE. You are solely responsible for determining the appropriateness of using or redistributing the Work and assume any risks associated with Your exercise of permissions under this License.
8. Limitation of Liability. In no event and under no legal theory, whether in tort (including negligence), contract, or otherwise, unless required by applicable law (such as deliberate and grossly negligent acts) or agreed to in writing, shall any Contributor be liable to You for damages, including any direct, indirect, special, incidental, or consequential damages of any character arising as a result of this License or out of the use or inability to use the Work (including but not limited to damages for loss of goodwill, work stoppage, computer failure or malfunction, or any and all other commercial damages or losses), even if such Contributor has been advised of the possibility of such damages.
9. Accepting Warranty or Additional Liability. While redistributing the Work or Derivative Works thereof, You may choose to offer, and charge a fee for, acceptance of support, warranty, indemnity, or other liability obligations and/or rights consistent with this License. However, in accepting such obligations, You may act only on Your own behalf and on Your sole responsibility, not on behalf of any other Contributor, and only if You agree to indemnify, defend, and hold each Contributor harmless for any liability incurred by, or claims asserted against, such Contributor by reason of your accepting any such warranty or additional liability.

END OF TERMS AND CONDITIONS

APPENDIX: How to apply the Apache License to your work.

To apply the Apache License to your work, attach the following boilerplate notice, with the fields enclosed by brackets "{}" replaced with your own identifying information. (Don't include the brackets!) The text should be enclosed in the appropriate comment syntax for the file format. We also recommend that a file or class name and description of purpose be included on the same "printed page" as the copyright notice for easier identification within third-party archives.

Copyright 2017 - 2022 R. Thomas  
Copyright 2017 - 2022 Quarkslab

Licensed under the Apache License, Version 2.0 (the "License");  
you may not use this file except in compliance with the License.  
You may obtain a copy of the License at

<http://www.apache.org/licenses/LICENSE-2.0>

Unless required by applicable law or agreed to in writing, software  
distributed under the License is distributed on an "AS IS" BASIS,  
WITHOUT WARRANTIES OR CONDITIONS OF ANY KIND, either express or implied.  
See the License for the specific language governing permissions and  
limitations under the License.

""""

""""

- OpenSSL, located at deps/openssl, is licensed as follows:

""""

Apache License  
Version 2.0, January 2004  
<https://www.apache.org/licenses/>

#### TERMS AND CONDITIONS FOR USE, REPRODUCTION, AND DISTRIBUTION

##### 1. Definitions.

"License" shall mean the terms and conditions for use, reproduction,  
and distribution as defined by Sections 1 through 9 of this document.

"Licensor" shall mean the copyright owner or entity authorized by  
the copyright owner that is granting the License.

"Legal Entity" shall mean the union of the acting entity and all  
other entities that control, are controlled by, or are under common  
control with that entity. For the purposes of this definition,  
"control" means (i) the power, direct or indirect, to cause the  
direction or management of such entity, whether by contract or  
otherwise, or (ii) ownership of fifty percent (50%) or more of the  
outstanding shares, or (iii) beneficial ownership of such entity.

"You" (or "Your") shall mean an individual or Legal Entity  
exercising permissions granted by this License.

"Source" form shall mean the preferred form for making modifications,  
including but not limited to software source code, documentation  
source, and configuration files.

"Object" form shall mean any form resulting from mechanical  
transformation or translation of a Source form, including but  
not limited to compiled object code, generated documentation,  
and conversions to other media types.

"Work" shall mean the work of authorship, whether in Source or  
Object form, made available under the License, as indicated by a  
copyright notice that is included in or attached to the work  
(an example is provided in the Appendix below).

"Derivative Works" shall mean any work, whether in Source or Object  
form, that is based on (or derived from) the Work and for which the  
editorial revisions, annotations, elaborations, or other modifications  
represent, as a whole, an original work of authorship. For the purposes  
of this License, Derivative Works shall not include works that remain

separable from, or merely link (or bind by name) to the interfaces of, the Work and Derivative Works thereof.

"Contribution" shall mean any work of authorship, including the original version of the Work and any modifications or additions to that Work or Derivative Works thereof, that is intentionally submitted to Licensor for inclusion in the Work by the copyright owner or by an individual or Legal Entity authorized to submit on behalf of the copyright owner. For the purposes of this definition, "submitted" means any form of electronic, verbal, or written communication sent to the Licensor or its representatives, including but not limited to communication on electronic mailing lists, source code control systems, and issue tracking systems that are managed by, or on behalf of, the Licensor for the purpose of discussing and improving the Work, but excluding communication that is conspicuously marked or otherwise designated in writing by the copyright owner as "Not a Contribution."

"Contributor" shall mean Licensor and any individual or Legal Entity on behalf of whom a Contribution has been received by Licensor and subsequently incorporated within the Work.

2. Grant of Copyright License. Subject to the terms and conditions of this License, each Contributor hereby grants to You a perpetual, worldwide, non-exclusive, no-charge, royalty-free, irrevocable copyright license to reproduce, prepare Derivative Works of, publicly display, publicly perform, sublicense, and distribute the Work and such Derivative Works in Source or Object form.
3. Grant of Patent License. Subject to the terms and conditions of this License, each Contributor hereby grants to You a perpetual, worldwide, non-exclusive, no-charge, royalty-free, irrevocable (except as stated in this section) patent license to make, have made, use, offer to sell, sell, import, and otherwise transfer the Work, where such license applies only to those patent claims licensable by such Contributor that are necessarily infringed by their Contribution(s) alone or by combination of their Contribution(s) with the Work to which such Contribution(s) was submitted. If You institute patent litigation against any entity (including a cross-claim or counterclaim in a lawsuit) alleging that the Work or a Contribution incorporated within the Work constitutes direct or contributory patent infringement, then any patent licenses granted to You under this License for that Work shall terminate as of the date such litigation is filed.
4. Redistribution. You may reproduce and distribute copies of the Work or Derivative Works thereof in any medium, with or without modifications, and in Source or Object form, provided that You meet the following conditions:
  - (a) You must give any other recipients of the Work or Derivative Works a copy of this License; and
  - (b) You must cause any modified files to carry prominent notices stating that You changed the files; and
  - (c) You must retain, in the Source form of any Derivative Works that You distribute, all copyright, patent, trademark, and

attribution notices from the Source form of the Work, excluding those notices that do not pertain to any part of the Derivative Works; and

- (d) If the Work includes a "NOTICE" text file as part of its distribution, then any Derivative Works that You distribute must include a readable copy of the attribution notices contained within such NOTICE file, excluding those notices that do not pertain to any part of the Derivative Works, in at least one of the following places: within a NOTICE text file distributed as part of the Derivative Works; within the Source form or documentation, if provided along with the Derivative Works; or, within a display generated by the Derivative Works, if and wherever such third-party notices normally appear. The contents of the NOTICE file are for informational purposes only and do not modify the License. You may add Your own attribution notices within Derivative Works that You distribute, alongside or as an addendum to the NOTICE text from the Work, provided that such additional attribution notices cannot be construed as modifying the License.

You may add Your own copyright statement to Your modifications and may provide additional or different license terms and conditions for use, reproduction, or distribution of Your modifications, or for any such Derivative Works as a whole, provided Your use, reproduction, and distribution of the Work otherwise complies with the conditions stated in this License.

5. **Submission of Contributions.** Unless You explicitly state otherwise, any Contribution intentionally submitted for inclusion in the Work by You to the Licensor shall be under the terms and conditions of this License, without any additional terms or conditions. Notwithstanding the above, nothing herein shall supersede or modify the terms of any separate license agreement you may have executed with Licensor regarding such Contributions.
6. **Trademarks.** This License does not grant permission to use the trade names, trademarks, service marks, or product names of the Licensor, except as required for reasonable and customary use in describing the origin of the Work and reproducing the content of the NOTICE file.
7. **Disclaimer of Warranty.** Unless required by applicable law or agreed to in writing, Licensor provides the Work (and each Contributor provides its Contributions) on an "AS IS" BASIS, WITHOUT WARRANTIES OR CONDITIONS OF ANY KIND, either express or implied, including, without limitation, any warranties or conditions of TITLE, NON-INFRINGEMENT, MERCHANTABILITY, or FITNESS FOR A PARTICULAR PURPOSE. You are solely responsible for determining the appropriateness of using or redistributing the Work and assume any risks associated with Your exercise of permissions under this License.
8. **Limitation of Liability.** In no event and under no legal theory, whether in tort (including negligence), contract, or otherwise, unless required by applicable law (such as deliberate and grossly negligent acts) or agreed to in writing, shall any Contributor be liable to You for damages, including any direct, indirect, special,

incidental, or consequential damages of any character arising as a result of this License or out of the use or inability to use the Work (including but not limited to damages for loss of goodwill, work stoppage, computer failure or malfunction, or any and all other commercial damages or losses), even if such Contributor has been advised of the possibility of such damages.

9. Accepting Warranty or Additional Liability. While redistributing the Work or Derivative Works thereof, You may choose to offer, and charge a fee for, acceptance of support, warranty, indemnity, or other liability obligations and/or rights consistent with this License. However, in accepting such obligations, You may act only on Your own behalf and on Your sole responsibility, not on behalf of any other Contributor, and only if You agree to indemnify, defend, and hold each Contributor harmless for any liability incurred by, or claims asserted against, such Contributor by reason of your accepting any such warranty or additional liability.

END OF TERMS AND CONDITIONS

""""

- Punycode.js, located at lib/punycode.js, is licensed as follows:

""""

Copyright Mathias Bynens <<https://mathiasbynens.be/>>

Permission is hereby granted, free of charge, to any person obtaining a copy of this software and associated documentation files (the "Software"), to deal in the Software without restriction, including without limitation the rights to use, copy, modify, merge, publish, distribute, sublicense, and/or sell copies of the Software, and to permit persons to whom the Software is furnished to do so, subject to the following conditions:

The above copyright notice and this permission notice shall be included in all copies or substantial portions of the Software.

THE SOFTWARE IS PROVIDED "AS IS", WITHOUT WARRANTY OF ANY KIND, EXPRESS OR IMPLIED, INCLUDING BUT NOT LIMITED TO THE WARRANTIES OF MERCHANTABILITY, FITNESS FOR A PARTICULAR PURPOSE AND NONINFRINGEMENT. IN NO EVENT SHALL THE AUTHORS OR COPYRIGHT HOLDERS BE LIABLE FOR ANY CLAIM, DAMAGES OR OTHER LIABILITY, WHETHER IN AN ACTION OF CONTRACT, TORT OR OTHERWISE, ARISING FROM, OUT OF OR IN CONNECTION WITH THE SOFTWARE OR THE USE OR OTHER DEALINGS IN THE SOFTWARE.

""""

- V8, located at deps/v8, is licensed as follows:

""""

This license applies to all parts of V8 that are not externally maintained libraries. The externally maintained libraries used by V8 are:

- PCRE test suite, located in test/mjsunit/third\_party/regexp-pcre/regexp-pcre.js. This is based on the test suite from PCRE-7.3, which is copyrighted by the University of Cambridge and Google, Inc. The copyright notice and license are embedded in regexp-pcre.js.

- Layout tests, located in `test/mjsunit/third_party/object-keys`. These are based on layout tests from [webkit.org](http://webkit.org) which are copyrighted by Apple Computer, Inc. and released under a 3-clause BSD license.
- Strongtalk assembler, the basis of the files `assembler-arm-inl.h`, [assembler-arm.cc](http://assembler-arm.cc), `assembler-arm.h`, `assembler-ia32-inl.h`, [assembler-ia32.cc](http://assembler-ia32.cc), `assembler-ia32.h`, `assembler-x64-inl.h`, [assembler-x64.cc](http://assembler-x64.cc), `assembler-x64.h`, [assembler.cc](http://assembler.cc) and `assembler.h`. This code is copyrighted by Sun Microsystems Inc. and released under a 3-clause BSD license.
- Valgrind client API header, located at `src/third_party/valgrind/valgrind.h`. This is released under the BSD license.
- The Wasm C/C++ API headers, located at `third_party/wasm-api/wasm.{h,hh}`. This is released under the Apache license. The API's upstream prototype implementation also formed the basis of V8's implementation in `src/wasm/c-api.cc`.

These libraries have their own licenses; we recommend you read them, as their terms may differ from the terms below.

Further license information can be found in LICENSE files located in sub-directories.

Copyright 2014, the V8 project authors. All rights reserved.  
Redistribution and use in source and binary forms, with or without modification, are permitted provided that the following conditions are met:

- \* Redistributions of source code must retain the above copyright notice, this list of conditions and the following disclaimer.
- \* Redistributions in binary form must reproduce the above copyright notice, this list of conditions and the following disclaimer in the documentation and/or other materials provided with the distribution.
- \* Neither the name of Google Inc. nor the names of its contributors may be used to endorse or promote products derived from this software without specific prior written permission.

THIS SOFTWARE IS PROVIDED BY THE COPYRIGHT HOLDERS AND CONTRIBUTORS "AS IS" AND ANY EXPRESS OR IMPLIED WARRANTIES, INCLUDING, BUT NOT LIMITED TO, THE IMPLIED WARRANTIES OF MERCHANTABILITY AND FITNESS FOR A PARTICULAR PURPOSE ARE DISCLAIMED. IN NO EVENT SHALL THE COPYRIGHT OWNER OR CONTRIBUTORS BE LIABLE FOR ANY DIRECT, INDIRECT, INCIDENTAL, SPECIAL, EXEMPLARY, OR CONSEQUENTIAL DAMAGES (INCLUDING, BUT NOT LIMITED TO, PROCUREMENT OF SUBSTITUTE GOODS OR SERVICES; LOSS OF USE, DATA, OR PROFITS; OR BUSINESS INTERRUPTION) HOWEVER CAUSED AND ON ANY THEORY OF LIABILITY, WHETHER IN CONTRACT, STRICT LIABILITY, OR TORT (INCLUDING NEGLIGENCE OR OTHERWISE) ARISING IN ANY WAY OUT OF THE USE OF THIS SOFTWARE, EVEN IF ADVISED OF THE POSSIBILITY OF SUCH DAMAGE.

""""

- SipHash, located at `deps/v8/src/third_party/siphash`, is licensed as follows:

""""

SipHash reference C implementation

Copyright (c) 2016 Jean-Philippe Aumasson <[jeanphilippe.aumasson@gmail.com](mailto:jeanphilippe.aumasson@gmail.com)>

To the extent possible under law, the author(s) have dedicated all copyright and related and neighboring rights to this software to the public domain worldwide. This software is distributed without any warranty.

""  
- zlib, located at deps/zlib, is licensed as follows:  
""

zlib.h -- interface of the 'zlib' general purpose compression library  
version 1.2.13, October 13th, 2022

Copyright (C) 1995-2022 Jean-loup Gailly and Mark Adler

This software is provided 'as-is', without any express or implied warranty. In no event will the authors be held liable for any damages arising from the use of this software.

Permission is granted to anyone to use this software for any purpose, including commercial applications, and to alter it and redistribute it freely, subject to the following restrictions:

1. The origin of this software must not be misrepresented; you must not claim that you wrote the original software. If you use this software in a product, an acknowledgment in the product documentation would be appreciated but is not required.
2. Altered source versions must be plainly marked as such, and must not be misrepresented as being the original software.
3. This notice may not be removed or altered from any source distribution.

Jean-loup Gailly    Mark Adler  
[jloup@gzip.org](mailto:jloup@gzip.org)    [madler@alumni.caltech.edu](mailto:madler@alumni.caltech.edu)

""  
- simdutf, located at deps/simdutf, is licensed as follows:  
""

Copyright 2021 The simdutf authors

Permission is hereby granted, free of charge, to any person obtaining a copy of this software and associated documentation files (the "Software"), to deal in the Software without restriction, including without limitation the rights to use, copy, modify, merge, publish, distribute, sublicense, and/or sell copies of the Software, and to permit persons to whom the Software is furnished to do so, subject to the following conditions:

The above copyright notice and this permission notice shall be included in all copies or substantial portions of the Software.

THE SOFTWARE IS PROVIDED "AS IS", WITHOUT WARRANTY OF ANY KIND, EXPRESS OR IMPLIED, INCLUDING BUT NOT LIMITED TO THE WARRANTIES OF MERCHANTABILITY, FITNESS FOR A PARTICULAR PURPOSE AND NONINFRINGEMENT. IN NO EVENT SHALL THE AUTHORS OR COPYRIGHT HOLDERS BE LIABLE FOR ANY CLAIM, DAMAGES OR OTHER LIABILITY, WHETHER IN AN ACTION OF CONTRACT, TORT OR OTHERWISE, ARISING FROM, OUT OF OR IN CONNECTION WITH THE SOFTWARE OR THE USE OR OTHER DEALINGS IN THE SOFTWARE.

""  
- ada, located at deps/ada, is licensed as follows:  
""  
Copyright 2023 Ada authors

Permission is hereby granted, free of charge, to any person obtaining a copy of this software and associated documentation files (the "Software"), to deal in the Software without restriction, including without limitation the rights to use, copy, modify, merge, publish, distribute, sublicense, and/or sell copies of the Software, and to permit persons to whom the Software is furnished to do so, subject to the following conditions:

The above copyright notice and this permission notice shall be included in all copies or substantial portions of the Software.

THE SOFTWARE IS PROVIDED "AS IS", WITHOUT WARRANTY OF ANY KIND, EXPRESS OR IMPLIED, INCLUDING BUT NOT LIMITED TO THE WARRANTIES OF MERCHANTABILITY, FITNESS FOR A PARTICULAR PURPOSE AND NONINFRINGEMENT. IN NO EVENT SHALL THE AUTHORS OR COPYRIGHT HOLDERS BE LIABLE FOR ANY CLAIM, DAMAGES OR OTHER LIABILITY, WHETHER IN AN ACTION OF CONTRACT, TORT OR OTHERWISE, ARISING FROM, OUT OF OR IN CONNECTION WITH THE SOFTWARE OR THE USE OR OTHER DEALINGS IN THE SOFTWARE.

""""

- npm, located at `deps/npm`, is licensed as follows:

""""

The npm application  
 Copyright (c) npm, Inc. and Contributors  
 Licensed on the terms of The Artistic License 2.0

Node package dependencies of the npm application  
 Copyright (c) their respective copyright owners  
 Licensed on their respective license terms

The npm public registry at <https://registry.npmjs.org>  
 and the npm website at <https://www.npmjs.com>  
 Operated by npm, Inc.  
 Use governed by terms published on <https://www.npmjs.com>

"Node.js"  
 Trademark Joyent, Inc., <https://joyent.com>  
 Neither npm nor npm, Inc. are affiliated with Joyent, Inc.

The Node.js application  
 Project of Node Foundation, <https://nodejs.org>

The npm Logo  
 Copyright (c) Mathias Pettersson and Brian Hammond

"Gubblebum Blocky" typeface  
 Copyright (c) Tjarda Koster, <https://jelloween.deviantart.com>  
 Used with permission

-----

The Artistic License 2.0

Copyright (c) 2000-2006, The Perl Foundation.

Everyone is permitted to copy and distribute verbatim copies of this license document, but changing it is not allowed.

Preamble

This license establishes the terms under which a given free software Package may be copied, modified, distributed, and/or redistributed. The intent is that the Copyright Holder maintains some artistic



control over the development of that Package while still keeping the Package available as open source and free software.

You are always permitted to make arrangements wholly outside of this license directly with the Copyright Holder of a given Package. If the terms of this license do not permit the full use that you propose to make of the Package, you should contact the Copyright Holder and seek a different licensing arrangement.

#### Definitions

"Copyright Holder" means the individual(s) or organization(s) named in the copyright notice for the entire Package.

"Contributor" means any party that has contributed code or other material to the Package, in accordance with the Copyright Holder's procedures.

"You" and "your" means any person who would like to copy, distribute, or modify the Package.

"Package" means the collection of files distributed by the Copyright Holder, and derivatives of that collection and/or of those files. A given Package may consist of either the Standard Version, or a Modified Version.

"Distribute" means providing a copy of the Package or making it accessible to anyone else, or in the case of a company or organization, to others outside of your company or organization.

"Distributor Fee" means any fee that you charge for Distributing this Package or providing support for this Package to another party. It does not mean licensing fees.

"Standard Version" refers to the Package if it has not been modified, or has been modified only in ways explicitly requested by the Copyright Holder.

"Modified Version" means the Package, if it has been changed, and such changes were not explicitly requested by the Copyright Holder.

"Original License" means this Artistic License as Distributed with the Standard Version of the Package, in its current version or as it may be modified by The Perl Foundation in the future.

"Source" form means the source code, documentation source, and configuration files for the Package.

"Compiled" form means the compiled bytecode, object code, binary, or any other form resulting from mechanical transformation or translation of the Source form.

#### Permission for Use and Modification Without Distribution

(1) You are permitted to use the Standard Version and create and use Modified Versions for any purpose without restriction, provided that you do not Distribute the Modified Version.

#### Permissions for Redistribution of the Standard Version

(2) You may Distribute verbatim copies of the Source form of the Standard Version of this Package in any medium without restriction, either gratis or for a Distributor Fee, provided that you duplicate all of the original copyright notices and associated disclaimers. At your discretion, such verbatim copies may or may not include a Compiled form of the Package.

(3) You may apply any bug fixes, portability changes, and other modifications made available from the Copyright Holder. The resulting Package will still be considered the Standard Version, and as such will be subject to the Original License.

#### Distribution of Modified Versions of the Package as Source

(4) You may Distribute your Modified Version as Source (either gratis or for a Distributor Fee, and with or without a Compiled form of the Modified Version) provided that you clearly document how it differs from the Standard Version, including, but not limited to, documenting any non-standard features, executables, or modules, and provided that you do at least ONE of the following:

(a) make the Modified Version available to the Copyright Holder of the Standard Version, under the Original License, so that the Copyright Holder may include your modifications in the Standard Version.

(b) ensure that installation of your Modified Version does not prevent the user installing or running the Standard Version. In addition, the Modified Version must bear a name that is different from the name of the Standard Version.

(c) allow anyone who receives a copy of the Modified Version to make the Source form of the Modified Version available to others under

(i) the Original License or

(ii) a license that permits the licensee to freely copy, modify and redistribute the Modified Version using the same licensing terms that apply to the copy that the licensee received, and requires that the Source form of the Modified Version, and of any works derived from it, be made freely available in that license fees are prohibited but Distributor Fees are allowed.

#### Distribution of Compiled Forms of the Standard Version or Modified Versions without the Source

(5) You may Distribute Compiled forms of the Standard Version without the Source, provided that you include complete instructions on how to get the Source of the Standard Version. Such instructions must be valid at the time of your distribution. If these instructions, at any time while you are carrying out such distribution, become invalid, you must provide new instructions on demand or cease further distribution. If you provide valid instructions or cease distribution within thirty days after you become aware that the instructions are invalid, then you do not forfeit any of your rights under this license.

(6) You may Distribute a Modified Version in Compiled form without the Source, provided that you comply with Section 4 with respect to the Source of the Modified Version.

#### Aggregating or Linking the Package

(7) You may aggregate the Package (either the Standard Version or Modified Version) with other packages and Distribute the resulting aggregation provided that you do not charge a licensing fee for the Package. Distributor Fees are permitted, and licensing fees for other components in the aggregation are permitted. The terms of this license apply to the use and Distribution of the Standard or Modified Versions as included in the aggregation.

(8) You are permitted to link Modified and Standard Versions with other works, to embed the Package in a larger work of your own, or to build stand-alone binary or bytecode versions of applications that include the Package, and Distribute the result without restriction, provided the result does not expose a direct interface to the Package.

#### Items That are Not Considered Part of a Modified Version

(9) Works (including, but not limited to, modules and scripts) that merely extend or make use of the Package, do not, by themselves, cause the Package to be a Modified Version. In addition, such works are not considered parts of the Package itself, and are not subject to the terms of this license.

#### General Provisions

(10) Any use, modification, and distribution of the Standard or Modified Versions is governed by this Artistic License. By using, modifying or distributing the Package, you accept this license. Do not use, modify, or distribute the Package, if you do not accept this license.

(11) If your Modified Version has been derived from a Modified Version made by someone other than you, you are nevertheless required to ensure that your Modified Version complies with the requirements of this license.

(12) This license does not grant you the right to use any trademark, service mark, tradename, or logo of the Copyright Holder.

(13) This license includes the non-exclusive, worldwide, free-of-charge patent license to make, have made, use, offer to sell, sell, import and otherwise transfer the Package with respect to any patent claims licensable by the Copyright Holder that are necessarily infringed by the Package. If you institute patent litigation (including a cross-claim or counterclaim) against any party alleging that the Package constitutes direct or contributory patent infringement, then this Artistic License to you shall terminate on the date that such litigation is filed.

(14) Disclaimer of Warranty:

THE PACKAGE IS PROVIDED BY THE COPYRIGHT HOLDER AND CONTRIBUTORS "AS IS" AND WITHOUT ANY EXPRESS OR IMPLIED WARRANTIES. THE IMPLIED WARRANTIES OF MERCHANTABILITY, FITNESS FOR A PARTICULAR PURPOSE, OR NON-INFRINGEMENT ARE DISCLAIMED TO THE EXTENT PERMITTED BY YOUR LOCAL

LAW. UNLESS REQUIRED BY LAW, NO COPYRIGHT HOLDER OR CONTRIBUTOR WILL BE LIABLE FOR ANY DIRECT, INDIRECT, INCIDENTAL, OR CONSEQUENTIAL DAMAGES ARISING IN ANY WAY OUT OF THE USE OF THE PACKAGE, EVEN IF ADVISED OF THE POSSIBILITY OF SUCH DAMAGE.

-----  
 """"

- GYP, located at tools/gyp, is licensed as follows:

""""

Copyright (c) 2020 Node.js contributors. All rights reserved.  
 Copyright (c) 2009 Google Inc. All rights reserved.

Redistribution and use in source and binary forms, with or without modification, are permitted provided that the following conditions are met:

- \* Redistributions of source code must retain the above copyright notice, this list of conditions and the following disclaimer.

- \* Redistributions in binary form must reproduce the above copyright notice, this list of conditions and the following disclaimer in the documentation and/or other materials provided with the distribution.

- \* Neither the name of Google Inc. nor the names of its contributors may be used to endorse or promote products derived from this software without specific prior written permission.

THIS SOFTWARE IS PROVIDED BY THE COPYRIGHT HOLDERS AND CONTRIBUTORS "AS IS" AND ANY EXPRESS OR IMPLIED WARRANTIES, INCLUDING, BUT NOT LIMITED TO, THE IMPLIED WARRANTIES OF MERCHANTABILITY AND FITNESS FOR A PARTICULAR PURPOSE ARE DISCLAIMED. IN NO EVENT SHALL THE COPYRIGHT OWNER OR CONTRIBUTORS BE LIABLE FOR ANY DIRECT, INDIRECT, INCIDENTAL, SPECIAL, EXEMPLARY, OR CONSEQUENTIAL DAMAGES (INCLUDING, BUT NOT LIMITED TO, PROCUREMENT OF SUBSTITUTE GOODS OR SERVICES; LOSS OF USE, DATA, OR PROFITS; OR BUSINESS INTERRUPTION) HOWEVER CAUSED AND ON ANY THEORY OF LIABILITY, WHETHER IN CONTRACT, STRICT LIABILITY, OR TORT (INCLUDING NEGLIGENCE OR OTHERWISE) ARISING IN ANY WAY OUT OF THE USE OF THIS SOFTWARE, EVEN IF ADVISED OF THE POSSIBILITY OF SUCH DAMAGE.

""""

- inspector\_protocol, located at tools/inspector\_protocol, is licensed as follows:

""""

```
// Copyright 2016 The Chromium Authors. All rights reserved.
//
// Redistribution and use in source and binary forms, with or without
// modification, are permitted provided that the following conditions are
// met:
//
// * Redistributions of source code must retain the above copyright
// notice, this list of conditions and the following disclaimer.
// * Redistributions in binary form must reproduce the above
// copyright notice, this list of conditions and the following disclaimer
// in the documentation and/or other materials provided with the
// distribution.
// * Neither the name of Google Inc. nor the names of its
// contributors may be used to endorse or promote products derived from
```

```
// this software without specific prior written permission.
//
// THIS SOFTWARE IS PROVIDED BY THE COPYRIGHT HOLDERS AND CONTRIBUTORS
// "AS IS" AND ANY EXPRESS OR IMPLIED WARRANTIES, INCLUDING, BUT NOT
// LIMITED TO, THE IMPLIED WARRANTIES OF MERCHANTABILITY AND FITNESS FOR
// A PARTICULAR PURPOSE ARE DISCLAIMED. IN NO EVENT SHALL THE COPYRIGHT
// OWNER OR CONTRIBUTORS BE LIABLE FOR ANY DIRECT, INDIRECT, INCIDENTAL,
// SPECIAL, EXEMPLARY, OR CONSEQUENTIAL DAMAGES (INCLUDING, BUT NOT
// LIMITED TO, PROCUREMENT OF SUBSTITUTE GOODS OR SERVICES; LOSS OF USE,
// DATA, OR PROFITS; OR BUSINESS INTERRUPTION) HOWEVER CAUSED AND ON ANY
// THEORY OF LIABILITY, WHETHER IN CONTRACT, STRICT LIABILITY, OR TORT
// (INCLUDING NEGLIGENCE OR OTHERWISE) ARISING IN ANY WAY OUT OF THE USE
// OF THIS SOFTWARE, EVEN IF ADVISED OF THE POSSIBILITY OF SUCH DAMAGE.
""""
```

- jinja2, located at tools/inspector\_protocol/jinja2, is licensed as follows:

```
""""
```

Copyright (c) 2009 by the Jinja Team, see AUTHORS for more details.

Some rights reserved.

Redistribution and use in source and binary forms, with or without modification, are permitted provided that the following conditions are met:

- \* Redistributions of source code must retain the above copyright notice, this list of conditions and the following disclaimer.
- \* Redistributions in binary form must reproduce the above copyright notice, this list of conditions and the following disclaimer in the documentation and/or other materials provided with the distribution.
- \* The names of the contributors may not be used to endorse or promote products derived from this software without specific prior written permission.

```
THIS SOFTWARE IS PROVIDED BY THE COPYRIGHT HOLDERS AND CONTRIBUTORS
"AS IS" AND ANY EXPRESS OR IMPLIED WARRANTIES, INCLUDING, BUT NOT
LIMITED TO, THE IMPLIED WARRANTIES OF MERCHANTABILITY AND FITNESS FOR
A PARTICULAR PURPOSE ARE DISCLAIMED. IN NO EVENT SHALL THE COPYRIGHT
OWNER OR CONTRIBUTORS BE LIABLE FOR ANY DIRECT, INDIRECT, INCIDENTAL,
SPECIAL, EXEMPLARY, OR CONSEQUENTIAL DAMAGES (INCLUDING, BUT NOT
LIMITED TO, PROCUREMENT OF SUBSTITUTE GOODS OR SERVICES; LOSS OF USE,
DATA, OR PROFITS; OR BUSINESS INTERRUPTION) HOWEVER CAUSED AND ON ANY
THEORY OF LIABILITY, WHETHER IN CONTRACT, STRICT LIABILITY, OR TORT
(INCLUDING NEGLIGENCE OR OTHERWISE) ARISING IN ANY WAY OUT OF THE USE
OF THIS SOFTWARE, EVEN IF ADVISED OF THE POSSIBILITY OF SUCH DAMAGE.
""""
```

- markupsafe, located at tools/inspector\_protocol/markupsafe, is licensed as follows:

```
""""
```

Copyright (c) 2010 by Armin Ronacher and contributors. See AUTHORS for more details.

Some rights reserved.

Redistribution and use in source and binary forms of the software as well as documentation, with or without modification, are permitted provided that the following conditions are met:

- \* Redistributions of source code must retain the above copyright notice, this list of conditions and the following disclaimer.
- \* Redistributions in binary form must reproduce the above copyright notice, this list of conditions and the following disclaimer in the documentation and/or other materials provided with the distribution.
- \* The names of the contributors may not be used to endorse or promote products derived from this software without specific prior written permission.

THIS SOFTWARE AND DOCUMENTATION IS PROVIDED BY THE COPYRIGHT HOLDERS AND CONTRIBUTORS "AS IS" AND ANY EXPRESS OR IMPLIED WARRANTIES, INCLUDING, BUT NOT LIMITED TO, THE IMPLIED WARRANTIES OF MERCHANTABILITY AND FITNESS FOR A PARTICULAR PURPOSE ARE DISCLAIMED. IN NO EVENT SHALL THE COPYRIGHT OWNER OR CONTRIBUTORS BE LIABLE FOR ANY DIRECT, INDIRECT, INCIDENTAL, SPECIAL, EXEMPLARY, OR CONSEQUENTIAL DAMAGES (INCLUDING, BUT NOT LIMITED TO, PROCUREMENT OF SUBSTITUTE GOODS OR SERVICES; LOSS OF USE, DATA, OR PROFITS; OR BUSINESS INTERRUPTION) HOWEVER CAUSED AND ON ANY THEORY OF LIABILITY, WHETHER IN CONTRACT, STRICT LIABILITY, OR TORT (INCLUDING NEGLIGENCE OR OTHERWISE) ARISING IN ANY WAY OUT OF THE USE OF THIS SOFTWARE AND DOCUMENTATION, EVEN IF ADVISED OF THE POSSIBILITY OF SUCH DAMAGE.

""""

- cpplint.py, located at tools/cpplint.py, is licensed as follows:

""""

Copyright (c) 2009 Google Inc. All rights reserved.

Redistribution and use in source and binary forms, with or without modification, are permitted provided that the following conditions are met:

- \* Redistributions of source code must retain the above copyright notice, this list of conditions and the following disclaimer.
- \* Redistributions in binary form must reproduce the above copyright notice, this list of conditions and the following disclaimer in the documentation and/or other materials provided with the distribution.
- \* Neither the name of Google Inc. nor the names of its contributors may be used to endorse or promote products derived from this software without specific prior written permission.

THIS SOFTWARE IS PROVIDED BY THE COPYRIGHT HOLDERS AND CONTRIBUTORS "AS IS" AND ANY EXPRESS OR IMPLIED WARRANTIES, INCLUDING, BUT NOT LIMITED TO, THE IMPLIED WARRANTIES OF MERCHANTABILITY AND FITNESS FOR A PARTICULAR PURPOSE ARE DISCLAIMED. IN NO EVENT SHALL THE COPYRIGHT OWNER OR CONTRIBUTORS BE LIABLE FOR ANY DIRECT, INDIRECT, INCIDENTAL, SPECIAL, EXEMPLARY, OR CONSEQUENTIAL DAMAGES (INCLUDING, BUT NOT LIMITED TO, PROCUREMENT OF SUBSTITUTE GOODS OR SERVICES; LOSS OF USE, DATA, OR PROFITS; OR BUSINESS INTERRUPTION) HOWEVER CAUSED AND ON ANY THEORY OF LIABILITY, WHETHER IN CONTRACT, STRICT LIABILITY, OR TORT

(INCLUDING NEGLIGENCE OR OTHERWISE) ARISING IN ANY WAY OUT OF THE USE OF THIS SOFTWARE, EVEN IF ADVISED OF THE POSSIBILITY OF SUCH DAMAGE.

""

- ESLint, located at tools/node\_modules/eslint, is licensed as follows:

""

Copyright OpenJS Foundation and other contributors, <[www.openjsf.org](http://www.openjsf.org)>

Permission is hereby granted, free of charge, to any person obtaining a copy of this software and associated documentation files (the "Software"), to deal in the Software without restriction, including without limitation the rights to use, copy, modify, merge, publish, distribute, sublicense, and/or sell copies of the Software, and to permit persons to whom the Software is furnished to do so, subject to the following conditions:

The above copyright notice and this permission notice shall be included in all copies or substantial portions of the Software.

THE SOFTWARE IS PROVIDED "AS IS", WITHOUT WARRANTY OF ANY KIND, EXPRESS OR IMPLIED, INCLUDING BUT NOT LIMITED TO THE WARRANTIES OF MERCHANTABILITY, FITNESS FOR A PARTICULAR PURPOSE AND NONINFRINGEMENT. IN NO EVENT SHALL THE AUTHORS OR COPYRIGHT HOLDERS BE LIABLE FOR ANY CLAIM, DAMAGES OR OTHER LIABILITY, WHETHER IN AN ACTION OF CONTRACT, TORT OR OTHERWISE, ARISING FROM, OUT OF OR IN CONNECTION WITH THE SOFTWARE OR THE USE OR OTHER DEALINGS IN THE SOFTWARE.

""

- gtest, located at deps/googletest, is licensed as follows:

""

Copyright 2008, Google Inc.  
All rights reserved.

Redistribution and use in source and binary forms, with or without modification, are permitted provided that the following conditions are met:

- \* Redistributions of source code must retain the above copyright notice, this list of conditions and the following disclaimer.

- \* Redistributions in binary form must reproduce the above copyright notice, this list of conditions and the following disclaimer in the documentation and/or other materials provided with the distribution.

- \* Neither the name of Google Inc. nor the names of its contributors may be used to endorse or promote products derived from this software without specific prior written permission.

THIS SOFTWARE IS PROVIDED BY THE COPYRIGHT HOLDERS AND CONTRIBUTORS "AS IS" AND ANY EXPRESS OR IMPLIED WARRANTIES, INCLUDING, BUT NOT LIMITED TO, THE IMPLIED WARRANTIES OF MERCHANTABILITY AND FITNESS FOR A PARTICULAR PURPOSE ARE DISCLAIMED. IN NO EVENT SHALL THE COPYRIGHT OWNER OR CONTRIBUTORS BE LIABLE FOR ANY DIRECT, INDIRECT, INCIDENTAL, SPECIAL, EXEMPLARY, OR CONSEQUENTIAL DAMAGES (INCLUDING, BUT NOT LIMITED TO, PROCUREMENT OF SUBSTITUTE GOODS OR SERVICES; LOSS OF USE, DATA, OR PROFITS; OR BUSINESS INTERRUPTION) HOWEVER CAUSED AND ON ANY THEORY OF LIABILITY, WHETHER IN CONTRACT, STRICT LIABILITY, OR TORT (INCLUDING NEGLIGENCE OR OTHERWISE) ARISING IN ANY WAY OUT OF THE USE

OF THIS SOFTWARE, EVEN IF ADVISED OF THE POSSIBILITY OF SUCH DAMAGE.

""

- nghttp2, located at deps/nghttp2, is licensed as follows:

""

The MIT License

Copyright (c) 2012, 2014, 2015, 2016 Tatsuhiro Tsujikawa

Copyright (c) 2012, 2014, 2015, 2016 nghttp2 contributors

Permission is hereby granted, free of charge, to any person obtaining a copy of this software and associated documentation files (the "Software"), to deal in the Software without restriction, including without limitation the rights to use, copy, modify, merge, publish, distribute, sublicense, and/or sell copies of the Software, and to permit persons to whom the Software is furnished to do so, subject to the following conditions:

The above copyright notice and this permission notice shall be included in all copies or substantial portions of the Software.

THE SOFTWARE IS PROVIDED "AS IS", WITHOUT WARRANTY OF ANY KIND, EXPRESS OR IMPLIED, INCLUDING BUT NOT LIMITED TO THE WARRANTIES OF MERCHANTABILITY, FITNESS FOR A PARTICULAR PURPOSE AND NONINFRINGEMENT. IN NO EVENT SHALL THE AUTHORS OR COPYRIGHT HOLDERS BE LIABLE FOR ANY CLAIM, DAMAGES OR OTHER LIABILITY, WHETHER IN AN ACTION OF CONTRACT, TORT OR OTHERWISE, ARISING FROM, OUT OF OR IN CONNECTION WITH THE SOFTWARE OR THE USE OR OTHER DEALINGS IN THE SOFTWARE.

""

- large\_pages, located at src/large\_pages, is licensed as follows:

""

Copyright (C) 2018 Intel Corporation

Permission is hereby granted, free of charge, to any person obtaining a copy of this software and associated documentation files (the "Software"), to deal in the Software without restriction, including without limitation the rights to use, copy, modify, merge, publish, distribute, sublicense, and/or sell copies of the Software, and to permit persons to whom the Software is furnished to do so, subject to the following conditions:

The above copyright notice and this permission notice shall be included in all copies or substantial portions of the Software.

THE SOFTWARE IS PROVIDED "AS IS", WITHOUT WARRANTY OF ANY KIND, EXPRESS OR IMPLIED, INCLUDING BUT NOT LIMITED TO THE WARRANTIES OF MERCHANTABILITY, FITNESS FOR A PARTICULAR PURPOSE AND NONINFRINGEMENT. IN NO EVENT SHALL THE AUTHORS OR COPYRIGHT HOLDERS BE LIABLE FOR ANY CLAIM, DAMAGES OR OTHER LIABILITY, WHETHER IN AN ACTION OF CONTRACT, TORT OR OTHERWISE, ARISING FROM, OUT OF OR IN CONNECTION WITH THE SOFTWARE OR THE USE OR OTHER DEALINGS IN THE SOFTWARE.

""

- caja, located at lib/internal/freeze\_intrinsics.js, is licensed as follows:

""

Adapted from SES/Caja - Copyright (C) 2011 Google Inc.

Copyright (C) 2018 Agoric



Licensed under the Apache License, Version 2.0 (the "License");  
you may not use this file except in compliance with the License.  
You may obtain a copy of the License at

<http://www.apache.org/licenses/LICENSE-2.0>

Unless required by applicable law or agreed to in writing, software  
distributed under the License is distributed on an "AS IS" BASIS,  
WITHOUT WARRANTIES OR CONDITIONS OF ANY KIND, either express or implied.  
See the License for the specific language governing permissions and  
limitations under the License.

""""

- brotli, located at deps/brotli, is licensed as follows:

""""

Copyright (c) 2009, 2010, 2013-2016 by the Brotli Authors.

Permission is hereby granted, free of charge, to any person obtaining a copy  
of this software and associated documentation files (the "Software"), to deal  
in the Software without restriction, including without limitation the rights  
to use, copy, modify, merge, publish, distribute, sublicense, and/or sell  
copies of the Software, and to permit persons to whom the Software is  
furnished to do so, subject to the following conditions:

The above copyright notice and this permission notice shall be included in  
all copies or substantial portions of the Software.

THE SOFTWARE IS PROVIDED "AS IS", WITHOUT WARRANTY OF ANY KIND, EXPRESS OR  
IMPLIED, INCLUDING BUT NOT LIMITED TO THE WARRANTIES OF MERCHANTABILITY,  
FITNESS FOR A PARTICULAR PURPOSE AND NONINFRINGEMENT. IN NO EVENT SHALL THE  
AUTHORS OR COPYRIGHT HOLDERS BE LIABLE FOR ANY CLAIM, DAMAGES OR OTHER  
LIABILITY, WHETHER IN AN ACTION OF CONTRACT, TORT OR OTHERWISE, ARISING FROM,  
OUT OF OR IN CONNECTION WITH THE SOFTWARE OR THE USE OR OTHER DEALINGS IN  
THE SOFTWARE.

""""

- HdrHistogram, located at deps/histogram, is licensed as follows:

""""

The code in this repository code was Written by Gil Tene, Michael Barker,  
and Matt Warren, and released to the public domain, as explained at  
<http://creativecommons.org/publicdomain/zero/1.0/>

For users of this code who wish to consume it under the "BSD" license  
rather than under the public domain or CC0 contribution text mentioned  
above, the code found under this directory is *\*also\** provided under the  
following license (commonly referred to as the BSD 2-Clause License). This  
license does not detract from the above stated release of the code into  
the public domain, and simply represents an additional license granted by  
the Author.

-----  
\*\* Beginning of "BSD 2-Clause License" text. \*\*

Copyright (c) 2012, 2013, 2014 Gil Tene  
Copyright (c) 2014 Michael Barker  
Copyright (c) 2014 Matt Warren  
All rights reserved.

Redistribution and use in source and binary forms, with or without modification, are permitted provided that the following conditions are met:

1. Redistributions of source code must retain the above copyright notice, this list of conditions and the following disclaimer.
2. Redistributions in binary form must reproduce the above copyright notice, this list of conditions and the following disclaimer in the documentation and/or other materials provided with the distribution.

THIS SOFTWARE IS PROVIDED BY THE COPYRIGHT HOLDERS AND CONTRIBUTORS "AS IS" AND ANY EXPRESS OR IMPLIED WARRANTIES, INCLUDING, BUT NOT LIMITED TO, THE IMPLIED WARRANTIES OF MERCHANTABILITY AND FITNESS FOR A PARTICULAR PURPOSE ARE DISCLAIMED. IN NO EVENT SHALL THE COPYRIGHT HOLDER OR CONTRIBUTORS BE LIABLE FOR ANY DIRECT, INDIRECT, INCIDENTAL, SPECIAL, EXEMPLARY, OR CONSEQUENTIAL DAMAGES (INCLUDING, BUT NOT LIMITED TO, PROCUREMENT OF SUBSTITUTE GOODS OR SERVICES; LOSS OF USE, DATA, OR PROFITS; OR BUSINESS INTERRUPTION) HOWEVER CAUSED AND ON ANY THEORY OF LIABILITY, WHETHER IN CONTRACT, STRICT LIABILITY, OR TORT (INCLUDING NEGLIGENCE OR OTHERWISE) ARISING IN ANY WAY OUT OF THE USE OF THIS SOFTWARE, EVEN IF ADVISED OF THE POSSIBILITY OF SUCH DAMAGE.

""""

- highlight.js, located at doc/api\_assets/highlight.pack.js, is licensed as follows:

""""

BSD 3-Clause License

Copyright (c) 2006, Ivan Sagalaev.  
All rights reserved.

Redistribution and use in source and binary forms, with or without modification, are permitted provided that the following conditions are met:

- \* Redistributions of source code must retain the above copyright notice, this list of conditions and the following disclaimer.
- \* Redistributions in binary form must reproduce the above copyright notice, this list of conditions and the following disclaimer in the documentation and/or other materials provided with the distribution.
- \* Neither the name of the copyright holder nor the names of its contributors may be used to endorse or promote products derived from this software without specific prior written permission.

THIS SOFTWARE IS PROVIDED BY THE COPYRIGHT HOLDERS AND CONTRIBUTORS "AS IS" AND ANY EXPRESS OR IMPLIED WARRANTIES, INCLUDING, BUT NOT LIMITED TO, THE IMPLIED WARRANTIES OF MERCHANTABILITY AND FITNESS FOR A PARTICULAR PURPOSE ARE DISCLAIMED. IN NO EVENT SHALL THE COPYRIGHT HOLDER OR CONTRIBUTORS BE LIABLE FOR ANY DIRECT, INDIRECT, INCIDENTAL, SPECIAL, EXEMPLARY, OR CONSEQUENTIAL DAMAGES (INCLUDING, BUT NOT LIMITED TO, PROCUREMENT OF SUBSTITUTE GOODS OR SERVICES; LOSS OF USE, DATA, OR PROFITS; OR BUSINESS INTERRUPTION) HOWEVER CAUSED AND ON ANY THEORY OF LIABILITY, WHETHER IN CONTRACT, STRICT LIABILITY, OR TORT (INCLUDING NEGLIGENCE OR OTHERWISE) ARISING IN ANY WAY OUT OF THE USE OF THIS SOFTWARE, EVEN IF ADVISED OF THE POSSIBILITY OF SUCH DAMAGE.

""""

- node-heapdump, located at src/heap\_utils.cc, is licensed as follows:

""""

ISC License

Copyright (c) 2012, Ben Noordhuis <info@bnoordhuis.nl>

Permission to use, copy, modify, and/or distribute this software for any purpose with or without fee is hereby granted, provided that the above copyright notice and this permission notice appear in all copies.

THE SOFTWARE IS PROVIDED "AS IS" AND THE AUTHOR DISCLAIMS ALL WARRANTIES WITH REGARD TO THIS SOFTWARE INCLUDING ALL IMPLIED WARRANTIES OF MERCHANTABILITY AND FITNESS. IN NO EVENT SHALL THE AUTHOR BE LIABLE FOR ANY SPECIAL, DIRECT, INDIRECT, OR CONSEQUENTIAL DAMAGES OR ANY DAMAGES WHATSOEVER RESULTING FROM LOSS OF USE, DATA OR PROFITS, WHETHER IN AN ACTION OF CONTRACT, NEGLIGENCE OR OTHER TORTIOUS ACTION, ARISING OUT OF OR IN CONNECTION WITH THE USE OR PERFORMANCE OF THIS SOFTWARE.

=== src/compat.h src/compat-inl.h ===

ISC License

Copyright (c) 2014, StrongLoop Inc.

Permission to use, copy, modify, and/or distribute this software for any purpose with or without fee is hereby granted, provided that the above copyright notice and this permission notice appear in all copies.

THE SOFTWARE IS PROVIDED "AS IS" AND THE AUTHOR DISCLAIMS ALL WARRANTIES WITH REGARD TO THIS SOFTWARE INCLUDING ALL IMPLIED WARRANTIES OF MERCHANTABILITY AND FITNESS. IN NO EVENT SHALL THE AUTHOR BE LIABLE FOR ANY SPECIAL, DIRECT, INDIRECT, OR CONSEQUENTIAL DAMAGES OR ANY DAMAGES WHATSOEVER RESULTING FROM LOSS OF USE, DATA OR PROFITS, WHETHER IN AN ACTION OF CONTRACT, NEGLIGENCE OR OTHER TORTIOUS ACTION, ARISING OUT OF OR IN CONNECTION WITH THE USE OR PERFORMANCE OF THIS SOFTWARE.

""""

- rimraf, located at lib/internal/fs/rimraf.js, is licensed as follows:

""""

The ISC License

Copyright (c) Isaac Z. Schlueter and Contributors

Permission to use, copy, modify, and/or distribute this software for any purpose with or without fee is hereby granted, provided that the above copyright notice and this permission notice appear in all copies.

THE SOFTWARE IS PROVIDED "AS IS" AND THE AUTHOR DISCLAIMS ALL WARRANTIES WITH REGARD TO THIS SOFTWARE INCLUDING ALL IMPLIED WARRANTIES OF MERCHANTABILITY AND FITNESS. IN NO EVENT SHALL THE AUTHOR BE LIABLE FOR ANY SPECIAL, DIRECT, INDIRECT, OR CONSEQUENTIAL DAMAGES OR ANY DAMAGES WHATSOEVER RESULTING FROM LOSS OF USE, DATA OR PROFITS, WHETHER IN AN ACTION OF CONTRACT, NEGLIGENCE OR OTHER TORTIOUS ACTION, ARISING OUT OF OR IN CONNECTION WITH THE USE OR PERFORMANCE OF THIS SOFTWARE.

""""

- uvwasi, located at deps/uvwasi, is licensed as follows:

""""

MIT License

Copyright (c) 2019 Colin Ihrig and Contributors

Permission is hereby granted, free of charge, to any person obtaining a copy of this software and associated documentation files (the "Software"), to deal in the Software without restriction, including without limitation the rights to use, copy, modify, merge, publish, distribute, sublicense, and/or sell copies of the Software, and to permit persons to whom the Software is furnished to do so, subject to the following conditions:

The above copyright notice and this permission notice shall be included in all copies or substantial portions of the Software.

THE SOFTWARE IS PROVIDED "AS IS", WITHOUT WARRANTY OF ANY KIND, EXPRESS OR IMPLIED, INCLUDING BUT NOT LIMITED TO THE WARRANTIES OF MERCHANTABILITY, FITNESS FOR A PARTICULAR PURPOSE AND NONINFRINGEMENT. IN NO EVENT SHALL THE AUTHORS OR COPYRIGHT HOLDERS BE LIABLE FOR ANY CLAIM, DAMAGES OR OTHER LIABILITY, WHETHER IN AN ACTION OF CONTRACT, TORT OR OTHERWISE, ARISING FROM, OUT OF OR IN CONNECTION WITH THE SOFTWARE OR THE USE OR OTHER DEALINGS IN THE SOFTWARE.

""""

- ngtcp2, located at deps/ngtcp2/ngtcp2/, is licensed as follows:

""""

The MIT License

Copyright (c) 2016 ngtcp2 contributors

Permission is hereby granted, free of charge, to any person obtaining a copy of this software and associated documentation files (the "Software"), to deal in the Software without restriction, including without limitation the rights to use, copy, modify, merge, publish, distribute, sublicense, and/or sell copies of the Software, and to permit persons to whom the Software is furnished to do so, subject to the following conditions:

The above copyright notice and this permission notice shall be included in all copies or substantial portions of the Software.

THE SOFTWARE IS PROVIDED "AS IS", WITHOUT WARRANTY OF ANY KIND, EXPRESS OR IMPLIED, INCLUDING BUT NOT LIMITED TO THE WARRANTIES OF MERCHANTABILITY, FITNESS FOR A PARTICULAR PURPOSE AND NONINFRINGEMENT. IN NO EVENT SHALL THE AUTHORS OR COPYRIGHT HOLDERS BE LIABLE FOR ANY CLAIM, DAMAGES OR OTHER LIABILITY, WHETHER IN AN ACTION OF CONTRACT, TORT OR OTHERWISE, ARISING FROM, OUT OF OR IN CONNECTION WITH THE SOFTWARE OR THE USE OR OTHER DEALINGS IN THE SOFTWARE.

""""

- nghttp3, located at deps/ngtcp2/nghttp3/, is licensed as follows:

""""

The MIT License

Copyright (c) 2019 nghttp3 contributors

Permission is hereby granted, free of charge, to any person obtaining a copy of this software and associated documentation files (the "Software"), to deal in the Software without restriction, including without limitation the rights to use, copy, modify, merge, publish, distribute, sublicense, and/or sell copies of the Software, and to

permit persons to whom the Software is furnished to do so, subject to the following conditions:

The above copyright notice and this permission notice shall be included in all copies or substantial portions of the Software.

THE SOFTWARE IS PROVIDED "AS IS", WITHOUT WARRANTY OF ANY KIND, EXPRESS OR IMPLIED, INCLUDING BUT NOT LIMITED TO THE WARRANTIES OF MERCHANTABILITY, FITNESS FOR A PARTICULAR PURPOSE AND NONINFRINGEMENT. IN NO EVENT SHALL THE AUTHORS OR COPYRIGHT HOLDERS BE LIABLE FOR ANY CLAIM, DAMAGES OR OTHER LIABILITY, WHETHER IN AN ACTION OF CONTRACT, TORT OR OTHERWISE, ARISING FROM, OUT OF OR IN CONNECTION WITH THE SOFTWARE OR THE USE OR OTHER DEALINGS IN THE SOFTWARE.

""""

- node-fs-extra, located at lib/internal/fs/cp, is licensed as follows:

""""

(The MIT License)

Copyright (c) 2011-2017 JP Richardson

Permission is hereby granted, free of charge, to any person obtaining a copy of this software and associated documentation files

(the 'Software'), to deal in the Software without restriction, including without limitation the rights to use, copy, modify,

merge, publish, distribute, sublicense, and/or sell copies of the Software, and to permit persons to whom the Software is

furnished to do so, subject to the following conditions:

The above copyright notice and this permission notice shall be included in all copies or substantial portions of the Software.

THE SOFTWARE IS PROVIDED 'AS IS', WITHOUT WARRANTY OF ANY KIND, EXPRESS OR IMPLIED, INCLUDING BUT NOT LIMITED TO THE

WARRANTIES OF MERCHANTABILITY, FITNESS FOR A PARTICULAR PURPOSE AND NONINFRINGEMENT. IN NO EVENT SHALL THE AUTHORS

OR COPYRIGHT HOLDERS BE LIABLE FOR ANY CLAIM, DAMAGES OR OTHER LIABILITY, WHETHER IN AN ACTION OF CONTRACT, TORT OR OTHERWISE,

ARISING FROM, OUT OF OR IN CONNECTION WITH THE SOFTWARE OR THE USE OR OTHER DEALINGS IN THE SOFTWARE.

""""

- base64, located at deps/base64/base64/, is licensed as follows:

""""

Copyright (c) 2005-2007, Nick Galbreath

Copyright (c) 2013-2019, Alfred Klomp

Copyright (c) 2015-2017, Wojciech Mula

Copyright (c) 2016-2017, Matthieu Darbois

All rights reserved.

Redistribution and use in source and binary forms, with or without modification, are permitted provided that the following conditions are met:

- Redistributions of source code must retain the above copyright notice, this list of conditions and the following disclaimer.

- Redistributions in binary form must reproduce the above copyright notice, this list of conditions and the following disclaimer in the documentation and/or other materials provided with the distribution.

THIS SOFTWARE IS PROVIDED BY THE COPYRIGHT HOLDERS AND CONTRIBUTORS "AS IS" AND ANY EXPRESS OR IMPLIED WARRANTIES, INCLUDING, BUT NOT LIMITED TO, THE IMPLIED WARRANTIES OF MERCHANTABILITY AND FITNESS FOR A PARTICULAR PURPOSE ARE DISCLAIMED. IN NO EVENT SHALL THE COPYRIGHT HOLDER OR CONTRIBUTORS BE LIABLE FOR ANY DIRECT, INDIRECT, INCIDENTAL, SPECIAL, EXEMPLARY, OR CONSEQUENTIAL DAMAGES (INCLUDING, BUT NOT LIMITED TO, PROCUREMENT OF SUBSTITUTE GOODS OR SERVICES; LOSS OF USE, DATA, OR PROFITS; OR BUSINESS INTERRUPTION) HOWEVER CAUSED AND ON ANY THEORY OF LIABILITY, WHETHER IN CONTRACT, STRICT LIABILITY, OR TORT (INCLUDING NEGLIGENCE OR OTHERWISE) ARISING IN ANY WAY OUT OF THE USE OF THIS SOFTWARE, EVEN IF ADVISED OF THE POSSIBILITY OF SUCH DAMAGE.

""""

---

## 7.8 Npm

The npm application

Copyright (c) npm, Inc. and Contributors

Licensed on the terms of The Artistic License 2.0

Node package dependencies of the npm application

Copyright (c) their respective copyright owners

Licensed on their respective license terms

The npm public registry at <https://registry.npmjs.org>

and the npm website at <https://www.npmjs.com>

Operated by npm, Inc.

Use governed by terms published on <https://www.npmjs.com>

"Node.js"

Trademark Joyent, Inc., <https://joyent.com>

Neither npm nor npm, Inc. are affiliated with Joyent, Inc.

The Node.js application

Project of Node Foundation, <https://nodejs.org>

The npm Logo

Copyright (c) Mathias Petterson and Brian Hammond

"Gubblebum Blocky" typeface

Copyright (c) Tjarda Koster, <https://jelloween.deviantart.com>

Used with permission

-----

The Artistic License 2.0

Copyright (c) 2000-2006, The Perl Foundation.

Everyone is permitted to copy and distribute verbatim copies of this license document, but changing it is not allowed.

Preamble

This license establishes the terms under which a given free software Package may be copied, modified, distributed, and/or redistributed. The intent is that the Copyright Holder maintains some artistic control over the development of that Package while still keeping the Package available as open source and free software.

You are always permitted to make arrangements wholly outside of this license directly with the Copyright Holder of a given Package. If the terms of this license do not permit the full use that you propose to make of the Package, you should contact the Copyright Holder and seek a different licensing arrangement.

Definitions

"Copyright Holder" means the individual(s) or organization(s) named in the copyright notice for the entire Package.

"Contributor" means any party that has contributed code or other material to the Package, in accordance with the Copyright Holder's procedures.

"You" and "your" means any person who would like to copy, distribute, or modify the Package.

"Package" means the collection of files distributed by the Copyright Holder, and derivatives of that collection and/or of those files. A given Package may consist of either the Standard Version, or a Modified Version.

"Distribute" means providing a copy of the Package or making it accessible to anyone else, or in the case of a company or organization, to others outside of your company or organization.

"Distributor Fee" means any fee that you charge for Distributing this Package or providing support for this Package to another party. It does not mean licensing fees.

"Standard Version" refers to the Package if it has not been modified, or has been modified only in ways explicitly requested by the Copyright Holder.

"Modified Version" means the Package, if it has been changed, and such changes were not explicitly requested by the Copyright Holder.

"Original License" means this Artistic License as Distributed with the Standard Version of the Package, in its current version or as it may be modified by The Perl Foundation in the future.

"Source" form means the source code, documentation source, and configuration files for the Package.

"Compiled" form means the compiled bytecode, object code, binary, or any other form resulting from mechanical transformation or translation of the Source form.

#### Permission for Use and Modification Without Distribution

(1) You are permitted to use the Standard Version and create and use Modified Versions for any purpose without restriction, provided that you do not Distribute the Modified Version.

#### Permissions for Redistribution of the Standard Version

(2) You may Distribute verbatim copies of the Source form of the Standard Version of this Package in any medium without restriction, either gratis or for a Distributor Fee, provided that you duplicate all of the original copyright notices and associated disclaimers. At your discretion, such verbatim copies may or may not include a Compiled form of the Package.

(3) You may apply any bug fixes, portability changes, and other modifications made available from the Copyright Holder. The resulting Package will still be considered the Standard Version, and as such will be subject to the Original License.



#### Distribution of Modified Versions of the Package as Source

(4) You may Distribute your Modified Version as Source (either gratis or for a Distributor Fee, and with or without a Compiled form of the Modified Version) provided that you clearly document how it differs from the Standard Version, including, but not limited to, documenting any non-standard features, executables, or modules, and provided that you do at least ONE of the following:

- (a) make the Modified Version available to the Copyright Holder of the Standard Version, under the Original License, so that the Copyright Holder may include your modifications in the Standard Version.
- (b) ensure that installation of your Modified Version does not prevent the user installing or running the Standard Version. In addition, the Modified Version must bear a name that is different from the name of the Standard Version.
- (c) allow anyone who receives a copy of the Modified Version to make the Source form of the Modified Version available to others under
  - (i) the Original License or
  - (ii) a license that permits the licensee to freely copy, modify and redistribute the Modified Version using the same licensing terms that apply to the copy that the licensee received, and requires that the Source form of the Modified Version, and of any works derived from it, be made freely available in that license fees are prohibited but Distributor Fees are allowed.

#### Distribution of Compiled Forms of the Standard Version or Modified Versions without the Source

(5) You may Distribute Compiled forms of the Standard Version without the Source, provided that you include complete instructions on how to get the Source of the Standard Version. Such instructions must be valid at the time of your distribution. If these instructions, at any time while you are carrying out such distribution, become invalid, you must provide new instructions on demand or cease further distribution. If you provide valid instructions or cease distribution within thirty days after you become aware that the instructions are invalid, then you do not forfeit any of your rights under this license.

(6) You may Distribute a Modified Version in Compiled form without the Source, provided that you comply with Section 4 with respect to the Source of the Modified Version.

#### Aggregating or Linking the Package

(7) You may aggregate the Package (either the Standard Version or Modified Version) with other packages and Distribute the resulting aggregation provided that you do not charge a licensing fee for the Package. Distributor Fees are permitted, and licensing fees for other

components in the aggregation are permitted. The terms of this license apply to the use and Distribution of the Standard or Modified Versions as included in the aggregation.

(8) You are permitted to link Modified and Standard Versions with other works, to embed the Package in a larger work of your own, or to build stand-alone binary or bytecode versions of applications that include the Package, and Distribute the result without restriction, provided the result does not expose a direct interface to the Package.

#### Items That are Not Considered Part of a Modified Version

(9) Works (including, but not limited to, modules and scripts) that merely extend or make use of the Package, do not, by themselves, cause the Package to be a Modified Version. In addition, such works are not considered parts of the Package itself, and are not subject to the terms of this license.

#### General Provisions

(10) Any use, modification, and distribution of the Standard or Modified Versions is governed by this Artistic License. By using, modifying or distributing the Package, you accept this license. Do not use, modify, or distribute the Package, if you do not accept this license.

(11) If your Modified Version has been derived from a Modified Version made by someone other than you, you are nevertheless required to ensure that your Modified Version complies with the requirements of this license.

(12) This license does not grant you the right to use any trademark, service mark, tradename, or logo of the Copyright Holder.

(13) This license includes the non-exclusive, worldwide, free-of-charge patent license to make, have made, use, offer to sell, sell, import and otherwise transfer the Package with respect to any patent claims licensable by the Copyright Holder that are necessarily infringed by the Package. If you institute patent litigation (including a cross-claim or counterclaim) against any party alleging that the Package constitutes direct or contributory patent infringement, then this Artistic License to you shall terminate on the date that such litigation is filed.

(14) Disclaimer of Warranty:

THE PACKAGE IS PROVIDED BY THE COPYRIGHT HOLDER AND CONTRIBUTORS "AS IS" AND WITHOUT ANY EXPRESS OR IMPLIED WARRANTIES. THE IMPLIED WARRANTIES OF MERCHANTABILITY, FITNESS FOR A PARTICULAR PURPOSE, OR NON-INFRINGEMENT ARE DISCLAIMED TO THE EXTENT PERMITTED BY YOUR LOCAL LAW. UNLESS REQUIRED BY LAW, NO COPYRIGHT HOLDER OR CONTRIBUTOR WILL BE LIABLE FOR ANY DIRECT, INDIRECT, INCIDENTAL, OR CONSEQUENTIAL DAMAGES ARISING IN ANY WAY OUT OF THE USE OF THE PACKAGE, EVEN IF ADVISED OF THE POSSIBILITY OF SUCH DAMAGE.

-----

## 7.8.1 npm packages MIT

Module Name	License	Repository
@babel/parser@7.20.5	MIT	<a href="https://github.com/babel/babel">https://github.com/babel/babel</a>
@esbuild-plugins/node-globals-polyfill@0.1.1	ISC	<a href="https://github.com/remorses/esbuild-plugins">https://github.com/remorses/esbuild-plugins</a>
@esbuild-plugins/node-modules-polyfill@0.1.4	ISC	<a href="https://github.com/remorses/esbuild-plugins">https://github.com/remorses/esbuild-plugins</a>
@fontsource/open-sans@4.5.13	MIT	<a href="https://github.com/fontsource/fontsource">https://github.com/fontsource/fontsource</a>
@jridgewell/sourcemap-codec@1.4.14	MIT	<a href="https://github.com/jridgewell/sourcemap-codec">https://github.com/jridgewell/sourcemap-codec</a>
@kurkle/color@0.3.2	MIT	<a href="https://github.com/kurkle/color">https://github.com/kurkle/color</a>
@logue/vue2-helpers@2.1.1	Apache-2.0	<a href="https://github.com/logue/vue2-helpers">https://github.com/logue/vue2-helpers</a>
@rollup/plugin-inject@5.0.3	MIT	<a href="https://github.com/rollup/plugins">https://github.com/rollup/plugins</a>
@rollup/pluginutils@5.0.2	MIT	<a href="https://github.com/rollup/plugins">https://github.com/rollup/plugins</a>
@types/d3-array@3.0.5	MIT	<a href="https://github.com/DefinitelyTyped/DefinitelyTyped">https://github.com/DefinitelyTyped/DefinitelyTyped</a>
@types/d3-axis@3.0.2	MIT	<a href="https://github.com/DefinitelyTyped/DefinitelyTyped">https://github.com/DefinitelyTyped/DefinitelyTyped</a>
@types/d3-brush@3.0.2	MIT	<a href="https://github.com/DefinitelyTyped/DefinitelyTyped">https://github.com/DefinitelyTyped/DefinitelyTyped</a>
@types/d3-chord@3.0.2	MIT	<a href="https://github.com/DefinitelyTyped/DefinitelyTyped">https://github.com/DefinitelyTyped/DefinitelyTyped</a>
@types/d3-color@3.1.0	MIT	<a href="https://github.com/DefinitelyTyped/DefinitelyTyped">https://github.com/DefinitelyTyped/DefinitelyTyped</a>
@types/d3-contour@3.0.2	MIT	<a href="https://github.com/DefinitelyTyped/DefinitelyTyped">https://github.com/DefinitelyTyped/DefinitelyTyped</a>

@types/d3-delaunay@6.0.1	MIT	<a href="https://github.com/DefinitelyTyped/DefinitelyTyped">https://github.com/DefinitelyTyped/DefinitelyTyped</a>
@types/d3-dispatch@3.0.2	MIT	<a href="https://github.com/DefinitelyTyped/DefinitelyTyped">https://github.com/DefinitelyTyped/DefinitelyTyped</a>
@types/d3-drag@3.0.2	MIT	<a href="https://github.com/DefinitelyTyped/DefinitelyTyped">https://github.com/DefinitelyTyped/DefinitelyTyped</a>
@types/d3-dsv@3.0.1	MIT	<a href="https://github.com/DefinitelyTyped/DefinitelyTyped">https://github.com/DefinitelyTyped/DefinitelyTyped</a>
@types/d3-ease@3.0.0	MIT	<a href="https://github.com/DefinitelyTyped/DefinitelyTyped">https://github.com/DefinitelyTyped/DefinitelyTyped</a>
@types/d3-fetch@3.0.2	MIT	<a href="https://github.com/DefinitelyTyped/DefinitelyTyped">https://github.com/DefinitelyTyped/DefinitelyTyped</a>
@types/d3-force@3.0.4	MIT	<a href="https://github.com/DefinitelyTyped/DefinitelyTyped">https://github.com/DefinitelyTyped/DefinitelyTyped</a>
@types/d3-format@3.0.1	MIT	<a href="https://github.com/DefinitelyTyped/DefinitelyTyped">https://github.com/DefinitelyTyped/DefinitelyTyped</a>
@types/d3-geo@3.0.3	MIT	<a href="https://github.com/DefinitelyTyped/DefinitelyTyped">https://github.com/DefinitelyTyped/DefinitelyTyped</a>
@types/d3-hierarchy@3.1.2	MIT	<a href="https://github.com/DefinitelyTyped/DefinitelyTyped">https://github.com/DefinitelyTyped/DefinitelyTyped</a>
@types/d3-interpolate@3.0.1	MIT	<a href="https://github.com/DefinitelyTyped/DefinitelyTyped">https://github.com/DefinitelyTyped/DefinitelyTyped</a>
@types/d3-path@3.0.0	MIT	<a href="https://github.com/DefinitelyTyped/DefinitelyTyped">https://github.com/DefinitelyTyped/DefinitelyTyped</a>
@types/d3-polygon@3.0.0	MIT	<a href="https://github.com/DefinitelyTyped/DefinitelyTyped">https://github.com/DefinitelyTyped/DefinitelyTyped</a>
@types/d3-quadtree@3.0.2	MIT	<a href="https://github.com/DefinitelyTyped/DefinitelyTyped">https://github.com/DefinitelyTyped/DefinitelyTyped</a>
@types/d3-random@3.0.1	MIT	<a href="https://github.com/DefinitelyTyped/DefinitelyTyped">https://github.com/DefinitelyTyped/DefinitelyTyped</a>

@types/d3-scale-chromatic@3.0.0	MIT	<a href="https://github.com/DefinitelyTyped/DefinitelyTyped">https://github.com/DefinitelyTyped/DefinitelyTyped</a>
@types/d3-scale@4.0.3	MIT	<a href="https://github.com/DefinitelyTyped/DefinitelyTyped">https://github.com/DefinitelyTyped/DefinitelyTyped</a>
@types/d3-selection@3.0.5	MIT	<a href="https://github.com/DefinitelyTyped/DefinitelyTyped">https://github.com/DefinitelyTyped/DefinitelyTyped</a>
@types/d3-shape@3.1.1	MIT	<a href="https://github.com/DefinitelyTyped/DefinitelyTyped">https://github.com/DefinitelyTyped/DefinitelyTyped</a>
@types/d3-time-format@4.0.0	MIT	<a href="https://github.com/DefinitelyTyped/DefinitelyTyped">https://github.com/DefinitelyTyped/DefinitelyTyped</a>
@types/d3-time@3.0.0	MIT	<a href="https://github.com/DefinitelyTyped/DefinitelyTyped">https://github.com/DefinitelyTyped/DefinitelyTyped</a>
@types/d3-timer@3.0.0	MIT	<a href="https://github.com/DefinitelyTyped/DefinitelyTyped">https://github.com/DefinitelyTyped/DefinitelyTyped</a>
@types/d3-transition@3.0.3	MIT	<a href="https://github.com/DefinitelyTyped/DefinitelyTyped">https://github.com/DefinitelyTyped/DefinitelyTyped</a>
@types/d3-zoom@3.0.3	MIT	<a href="https://github.com/DefinitelyTyped/DefinitelyTyped">https://github.com/DefinitelyTyped/DefinitelyTyped</a>
@types/d3@7.4.0	MIT	<a href="https://github.com/DefinitelyTyped/DefinitelyTyped">https://github.com/DefinitelyTyped/DefinitelyTyped</a>
@types/estree@1.0.0	MIT	<a href="https://github.com/DefinitelyTyped/DefinitelyTyped">https://github.com/DefinitelyTyped/DefinitelyTyped</a>
@types/geojson@7946.0.10	MIT	<a href="https://github.com/DefinitelyTyped/DefinitelyTyped">https://github.com/DefinitelyTyped/DefinitelyTyped</a>
@types/uuid@9.0.2	MIT	<a href="https://github.com/DefinitelyTyped/DefinitelyTyped">https://github.com/DefinitelyTyped/DefinitelyTyped</a>
@vue/compiler-sfc@2.7.15	MIT*	<a href="https://github.com/vuejs/core">https://github.com/vuejs/core</a>
@vue/devtools-api@6.4.5	MIT	<a href="https://github.com/vuejs/vue-devtools">https://github.com/vuejs/vue-devtools</a>
chart.js@4.4.1	MIT	<a href="https://github.com/chartjs/Chart.js">https://github.com/chartjs/Chart.js</a>

commander@7.2.0	MIT	<a href="https://github.com/tj/commander.js">https://github.com/tj/commander.js</a>
csstype@3.1.1	MIT	<a href="https://github.com/frenic/csstype">https://github.com/frenic/csstype</a>
d3-array@3.2.1	ISC	<a href="https://github.com/d3/d3-array">https://github.com/d3/d3-array</a>
d3-axis@3.0.0	ISC	<a href="https://github.com/d3/d3-axis">https://github.com/d3/d3-axis</a>
d3-brush@3.0.0	ISC	<a href="https://github.com/d3/d3-brush">https://github.com/d3/d3-brush</a>
d3-chord@3.0.1	ISC	<a href="https://github.com/d3/d3-chord">https://github.com/d3/d3-chord</a>
d3-color@3.1.0	ISC	<a href="https://github.com/d3/d3-color">https://github.com/d3/d3-color</a>
d3-contour@4.0.2	ISC	<a href="https://github.com/d3/d3-contour">https://github.com/d3/d3-contour</a>
d3-delaunay@6.0.2	ISC	<a href="https://github.com/d3/d3-delaunay">https://github.com/d3/d3-delaunay</a>
d3-dispatch@3.0.1	ISC	<a href="https://github.com/d3/d3-dispatch">https://github.com/d3/d3-dispatch</a>
d3-drag@3.0.0	ISC	<a href="https://github.com/d3/d3-drag">https://github.com/d3/d3-drag</a>
d3-dsv@3.0.1	ISC	<a href="https://github.com/d3/d3-dsv">https://github.com/d3/d3-dsv</a>
d3-ease@3.0.1	BSD-3-Clause	<a href="https://github.com/d3/d3-ease">https://github.com/d3/d3-ease</a>
d3-fetch@3.0.1	ISC	<a href="https://github.com/d3/d3-fetch">https://github.com/d3/d3-fetch</a>
d3-force@3.0.0	ISC	<a href="https://github.com/d3/d3-force">https://github.com/d3/d3-force</a>
d3-format@3.1.0	ISC	<a href="https://github.com/d3/d3-format">https://github.com/d3/d3-format</a>
d3-geo@3.1.0	ISC	<a href="https://github.com/d3/d3-geo">https://github.com/d3/d3-geo</a>
d3-hierarchy@3.1.2	ISC	<a href="https://github.com/d3/d3-hierarchy">https://github.com/d3/d3-hierarchy</a>
d3-interpolate@3.0.1	ISC	<a href="https://github.com/d3/d3-interpolate">https://github.com/d3/d3-interpolate</a>
d3-path@3.1.0	ISC	<a href="https://github.com/d3/d3-path">https://github.com/d3/d3-path</a>
d3-polygon@3.0.1	ISC	<a href="https://github.com/d3/d3-polygon">https://github.com/d3/d3-polygon</a>

d3-quadtree@3.0.1	ISC	<a href="https://github.com/d3/d3-quadtree">https://github.com/d3/d3-quadtree</a>
d3-random@3.0.1	ISC	<a href="https://github.com/d3/d3-random">https://github.com/d3/d3-random</a>
d3-scale-chromatic@3.0.0	ISC	<a href="https://github.com/d3/d3-scale-chromatic">https://github.com/d3/d3-scale-chromatic</a>
d3-scale@4.0.2	ISC	<a href="https://github.com/d3/d3-scale">https://github.com/d3/d3-scale</a>
d3-selection@3.0.0	ISC	<a href="https://github.com/d3/d3-selection">https://github.com/d3/d3-selection</a>
d3-shape@3.2.0	ISC	<a href="https://github.com/d3/d3-shape">https://github.com/d3/d3-shape</a>
d3-time-format@4.1.0	ISC	<a href="https://github.com/d3/d3-time-format">https://github.com/d3/d3-time-format</a>
d3-time@3.1.0	ISC	<a href="https://github.com/d3/d3-time">https://github.com/d3/d3-time</a>
d3-timer@3.0.1	ISC	<a href="https://github.com/d3/d3-timer">https://github.com/d3/d3-timer</a>
d3-transition@3.0.1	ISC	<a href="https://github.com/d3/d3-transition">https://github.com/d3/d3-transition</a>
d3-zoom@3.0.0	ISC	<a href="https://github.com/d3/d3-zoom">https://github.com/d3/d3-zoom</a>
d3@7.8.1	ISC	<a href="https://github.com/d3/d3">https://github.com/d3/d3</a>
delaunator@5.0.0	ISC	<a href="https://github.com/mapbox/delaunator">https://github.com/mapbox/delaunator</a>
esbuild-windows-64@0.14.54	MIT	<a href="https://github.com/evanw/esbuild">https://github.com/evanw/esbuild</a>
esbuild@0.14.54	MIT	<a href="https://github.com/evanw/esbuild">https://github.com/evanw/esbuild</a>
escape-string-regexp@4.0.0	MIT	<a href="https://github.com/sindresorhus/escape-string-regexp">https://github.com/sindresorhus/escape-string-regexp</a>
estree-walker@0.6.1	MIT	<a href="https://github.com/Rich-Harris/estree-walker">https://github.com/Rich-Harris/estree-walker</a>
estree-walker@2.0.2	MIT	<a href="https://github.com/Rich-Harris/estree-walker">https://github.com/Rich-Harris/estree-walker</a>
iconv-lite@0.6.3	MIT	<a href="https://github.com/ashtuchkin/iconv-lite">https://github.com/ashtuchkin/iconv-lite</a>

internmap@2.0.3	ISC	<a href="https://github.com/mbostock/internmap">https://github.com/mbostock/internmap</a>
magic-string@0.25.9	MIT	<a href="https://github.com/rich-harris/magic-string">https://github.com/rich-harris/magic-string</a>
magic-string@0.27.0	MIT	<a href="https://github.com/rich-harris/magic-string">https://github.com/rich-harris/magic-string</a>
nanoid@3.3.7	MIT	<a href="https://github.com/ai/nanoid">https://github.com/ai/nanoid</a>
picocolors@1.0.0	ISC	<a href="https://github.com/alexeyraspopov/picocolors">https://github.com/alexeyraspopov/picocolors</a>
picomatch@2.3.1	MIT	<a href="https://github.com/micromatch/picomatch">https://github.com/micromatch/picomatch</a>
pinia@2.0.28	MIT	<a href="https://github.com/vuejs/pinia">https://github.com/vuejs/pinia</a>
postcss@8.4.33	MIT	<a href="https://github.com/postcss/postcss">https://github.com/postcss/postcss</a>
prismjs@1.29.0	MIT	<a href="https://github.com/PrismJS/prism">https://github.com/PrismJS/prism</a>
robust-predicates@3.0.1	Unlicense	<a href="https://github.com/mourner/robust-predicates">https://github.com/mourner/robust-predicates</a>
rollup-plugin-inject@3.0.2	MIT	<a href="https://github.com/rollup/rollup-plugin-inject">https://github.com/rollup/rollup-plugin-inject</a>
rollup-plugin-node-polyfills@0.2.1	MIT	<a href="https://github.com/ionic-team/rollup-plugin-node-polyfills">https://github.com/ionic-team/rollup-plugin-node-polyfills</a>
rollup-plugin-polyfill-node@0.11.0	MIT	<a href="https://github.com/FredKSchott/rollup-plugin-polyfill-node">https://github.com/FredKSchott/rollup-plugin-polyfill-node</a>
rollup-pluginutils@2.8.2	MIT	<a href="https://github.com/rollup/rollup-pluginutils">https://github.com/rollup/rollup-pluginutils</a>
rollup@2.77.3	MIT	<a href="https://github.com/rollup/rollup">https://github.com/rollup/rollup</a>
rw@1.3.3	BSD-3-Clause	<a href="https://github.com/mbostock/rw">https://github.com/mbostock/rw</a>
safer-buffer@2.1.2	MIT	<a href="https://github.com/ChALkeR/safer-buffer">https://github.com/ChALkeR/safer-buffer</a>



source-map-js@1.0.2	BSD-3-Clause	<a href="https://github.com/7rulnik/source-map-js">https://github.com/7rulnik/source-map-js</a>
source-map@0.6.1	BSD-3-Clause	<a href="https://github.com/mozilla/source-map">https://github.com/mozilla/source-map</a>
sourcemap-codec@1.4.8	MIT	<a href="https://github.com/Rich-Harris/sourcemap-codec">https://github.com/Rich-Harris/sourcemap-codec</a>
typescript@5.0.4	Apache-2.0	<a href="https://github.com/Microsoft/TypeScript">https://github.com/Microsoft/TypeScript</a>
uuid@9.0.0	MIT	<a href="https://github.com/uuidjs/uuid">https://github.com/uuidjs/uuid</a>
vue-chartjs@5.2.0	MIT	<a href="https://github.com/apertureless/vue-chartjs">https://github.com/apertureless/vue-chartjs</a>
vue-demi@0.13.11	MIT	<a href="https://github.com/antfu/vue-demi">https://github.com/antfu/vue-demi</a>
vue-demi@0.14.0	MIT	<a href="https://github.com/antfu/vue-demi">https://github.com/antfu/vue-demi</a>
vue-prism-editor@1.3.0	MIT	<a href="https://github.com/koca/vue-prism-editor">https://github.com/koca/vue-prism-editor</a>
vue-router@3.6.5	MIT	<a href="https://github.com/vuejs/vue-router">https://github.com/vuejs/vue-router</a>
vue@2.7.16	MIT	<a href="https://github.com/vuejs/vue">https://github.com/vuejs/vue</a>
vuetify@2.6.12	MIT	<a href="https://github.com/vuetifyjs/vuetify">https://github.com/vuetifyjs/vuetify</a>

---

## 7.9 Sep

### MIT License

Copyright (c) 2023 nietras

Permission is hereby granted, free of charge, to any person obtaining a copy of this software and associated documentation files (the "Software"), to deal in the Software without restriction, including without limitation the rights to use, copy, modify, merge, publish, distribute, sublicense, and/or sell copies of the Software, and to permit persons to whom the Software is furnished to do so, subject to the following conditions:

The above copyright notice and this permission notice shall be included in all copies or substantial portions of the Software.

THE SOFTWARE IS PROVIDED "AS IS", WITHOUT WARRANTY OF ANY KIND, EXPRESS OR IMPLIED, INCLUDING BUT NOT LIMITED TO THE WARRANTIES OF MERCHANTABILITY, FITNESS FOR A PARTICULAR PURPOSE AND NONINFRINGEMENT. IN NO EVENT SHALL THE AUTHORS OR COPYRIGHT HOLDERS BE LIABLE FOR ANY CLAIM, DAMAGES OR OTHER LIABILITY, WHETHER IN AN ACTION OF CONTRACT, TORT OR OTHERWISE, ARISING FROM, OUT OF OR IN CONNECTION WITH THE SOFTWARE OR THE USE OR OTHER DEALINGS IN THE SOFTWARE.

---

## 7.10 Serilog

Apache License

Version 2.0, January 2004

<http://www.apache.org/licenses/>

### TERMS AND CONDITIONS FOR USE, REPRODUCTION, AND DISTRIBUTION

#### 1. Definitions.

"License" shall mean the terms and conditions for use, reproduction, and distribution as defined by Sections 1 through 9 of this document.

"Licensor" shall mean the copyright owner or entity authorized by the copyright owner that is granting the License.

"Legal Entity" shall mean the union of the acting entity and all other entities that control, are controlled by, or are under common control with that entity. For the purposes of this definition, "control" means (i) the power, direct or indirect, to cause the direction or management of such entity, whether by contract or otherwise, or (ii) ownership of fifty percent (50%) or more of the outstanding shares, or (iii) beneficial ownership of such entity.

"You" (or "Your") shall mean an individual or Legal Entity exercising permissions granted by this License.

"Source" form shall mean the preferred form for making modifications, including but not limited to software source code, documentation source, and configuration files.

"Object" form shall mean any form resulting from mechanical transformation or translation of a Source form, including but not limited to compiled object code, generated documentation, and conversions to other media types.

"Work" shall mean the work of authorship, whether in Source or Object form, made available under the License, as indicated by a copyright notice that is included in or attached to the work (an example is provided in the Appendix below).

"Derivative Works" shall mean any work, whether in Source or Object form, that is based on (or derived from) the Work and for which the editorial revisions, annotations, elaborations, or other modifications represent, as a whole, an original work of authorship. For the purposes of this License, Derivative Works shall not include works that remain separable from, or merely link (or bind by name) to the interfaces of, the Work and Derivative Works thereof.

"Contribution" shall mean any work of authorship, including the original version of the Work and any modifications or additions to that Work or Derivative Works thereof, that is intentionally submitted to Licensor for inclusion in the Work by the copyright owner or by an individual or Legal Entity authorized to submit on behalf of the copyright owner. For the purposes of this definition, "submitted" means any form of electronic, verbal, or written communication sent to the Licensor or its representatives, including but not limited to communication on electronic mailing lists, source code control systems, and issue tracking systems that are managed by, or on behalf of, the Licensor for the purpose of discussing and improving the Work, but excluding communication

that is conspicuously marked or otherwise designated in writing by the copyright owner as "Not a Contribution."

"Contributor" shall mean Licensor and any individual or Legal Entity on behalf of whom a Contribution has been received by Licensor and subsequently incorporated within the Work.

#### 2. Grant of Copyright License.

Subject to the terms and conditions of this License, each Contributor hereby grants to You a perpetual, worldwide, non-exclusive, no-charge, royalty-free, irrevocable copyright license to reproduce, prepare Derivative Works of, publicly display, publicly perform, sublicense, and distribute the Work and such Derivative Works in Source or Object form.

#### 3. Grant of Patent License.

Subject to the terms and conditions of this License, each Contributor hereby grants to You a perpetual, worldwide, non-exclusive, no-charge, royalty-free, irrevocable (except as stated in this section) patent license to make, have made, use, offer to sell, sell, import, and otherwise transfer the Work, where such license applies only to those patent claims licensable by such Contributor that are necessarily infringed by their Contribution(s) alone or by combination of their Contribution(s) with the Work to which such Contribution(s) was submitted. If You institute patent litigation against any entity (including a cross-claim or counterclaim in a lawsuit) alleging that the Work or a Contribution incorporated within the Work constitutes direct or contributory patent infringement, then any patent licenses granted to You under this License for that Work shall terminate as of the date such litigation is filed.

#### 4. Redistribution.

You may reproduce and distribute copies of the Work or Derivative Works thereof in any medium, with or without modifications, and in Source or Object form, provided that You meet the following conditions:

You must give any other recipients of the Work or Derivative Works a copy of this License; and

You must cause any modified files to carry prominent notices stating that You changed the files; and

You must retain, in the Source form of any Derivative Works that You distribute, all copyright, patent, trademark, and attribution notices from the Source form of the Work, excluding those notices that do not pertain to any part of the Derivative Works; and

If the Work includes a "NOTICE" text file as part of its distribution, then any Derivative Works that You distribute must include a readable copy of the attribution notices contained within such NOTICE file, excluding those notices that do not pertain to any part of the Derivative Works, in at least one of the following places: within a NOTICE text file distributed as part of the Derivative Works; within the Source form or documentation, if provided along with the Derivative Works; or, within a display generated by the Derivative Works, if and wherever such third-party notices normally appear. The contents of the NOTICE file are for informational purposes only and do not modify the License. You may add Your own attribution notices within Derivative Works that You distribute, alongside or as an addendum to the NOTICE text from the Work, provided that such additional attribution notices cannot be construed as modifying the License.

You may add Your own copyright statement to Your modifications and may provide additional or different license terms and conditions for use, reproduction, or distribution of Your modifications, or for any such Derivative Works as a whole, provided Your use, reproduction, and distribution of the Work otherwise complies with the conditions stated in this License.

#### 5. Submission of Contributions.

Unless You explicitly state otherwise, any Contribution intentionally submitted for inclusion in the Work by You to the Licensor shall be under the terms and conditions of this License, without any additional terms or conditions. Notwithstanding the above, nothing herein shall supersede or modify the terms of any separate license agreement you may have executed with Licensor regarding such Contributions.

#### 6. Trademarks.

This License does not grant permission to use the trade names, trademarks, service marks, or product names of the Licensor, except as required for reasonable and customary use in describing the origin of the Work and reproducing the content of the NOTICE file.

#### 7. Disclaimer of Warranty.

Unless required by applicable law or agreed to in writing, Licensor provides the Work (and each Contributor provides its Contributions) on an "AS IS" BASIS, WITHOUT WARRANTIES OR CONDITIONS OF ANY KIND, either express or implied, including, without limitation, any warranties or conditions of TITLE, NON-INFRINGEMENT, MERCHANTABILITY, or FITNESS FOR A PARTICULAR PURPOSE. You are solely responsible for determining the appropriateness of using or redistributing the Work and assume any risks associated with Your exercise of permissions under this License.

#### 8. Limitation of Liability.

In no event and under no legal theory, whether in tort (including negligence), contract, or otherwise, unless required by applicable law (such as deliberate and grossly negligent acts) or agreed to in writing, shall any Contributor be liable to You for damages, including any direct, indirect, special, incidental, or consequential damages of any character arising as a result of this License or out of the use or inability to use the Work (including but not limited to damages for loss of goodwill, work stoppage, computer failure or malfunction, or any and all other commercial damages or losses), even if such Contributor has been advised of the possibility of such damages.

#### 9. Accepting Warranty or Additional Liability.

While redistributing the Work or Derivative Works thereof, You may choose to offer, and charge a fee for, acceptance of support, warranty, indemnity, or other liability obligations and/or rights consistent with this License. However, in accepting such obligations, You may act only on Your own behalf and on Your sole responsibility, not on behalf of any other Contributor, and only if You agree to indemnify, defend, and hold each Contributor harmless for any liability incurred by, or claims asserted against, such Contributor by reason of your accepting any such warranty or additional liability.

END OF TERMS AND CONDITIONS

APPENDIX: How to apply the Apache License to your work

To apply the Apache License to your work, attach the following boilerplate notice, with the fields enclosed by brackets "[]" replaced with your own identifying information. (Don't include the brackets!) The text should be enclosed in the appropriate comment syntax for the file format. We also recommend that a file or class name and description of purpose be included on the same "printed page" as the copyright notice for easier identification within third-party archives.

Copyright [yyyy] [name of copyright owner]

Licensed under the Apache License, Version 2.0 (the "License");  
you may not use this file except in compliance with the License.  
You may obtain a copy of the License at

<http://www.apache.org/licenses/LICENSE-2.0>

Unless required by applicable law or agreed to in writing, software  
distributed under the License is distributed on an "AS IS" BASIS,  
WITHOUT WARRANTIES OR CONDITIONS OF ANY KIND, either express or implied.  
See the License for the specific language governing permissions and  
limitations under the License.

---

## 7.11 Serilog Graylog Sink

MIT License

Copyright (c) 2016 Anton Volkov

Permission is hereby granted, free of charge, to any person obtaining a copy of this software and associated documentation files (the "Software"), to deal in the Software without restriction, including without limitation the rights to use, copy, modify, merge, publish, distribute, sublicense, and/or sell copies of the Software, and to permit persons to whom the Software is furnished to do so, subject to the following conditions:

The above copyright notice and this permission notice shall be included in all copies or substantial portions of the Software.

THE SOFTWARE IS PROVIDED "AS IS", WITHOUT WARRANTY OF ANY KIND, EXPRESS OR IMPLIED, INCLUDING BUT NOT LIMITED TO THE WARRANTIES OF MERCHANTABILITY, FITNESS FOR A PARTICULAR PURPOSE AND NONINFRINGEMENT. IN NO EVENT SHALL THE AUTHORS OR COPYRIGHT HOLDERS BE LIABLE FOR ANY CLAIM, DAMAGES OR OTHER LIABILITY, WHETHER IN AN ACTION OF CONTRACT, TORT OR OTHERWISE, ARISING FROM, OUT OF OR IN CONNECTION WITH THE SOFTWARE OR THE USE OR OTHER DEALINGS IN THE SOFTWARE.

---

## 7.12 SportzCast Library

### MIT License

Copyright (c) <year> <copyright holders>

Permission is hereby granted, free of charge, to any person obtaining a copy of this software and associated documentation files (the "Software"), to deal in the Software without restriction, including without limitation the rights to use, copy, modify, merge, publish, distribute, sublicense, and/or sell copies of the Software, and to permit persons to whom the Software is furnished to do so, subject to the following conditions:

The above copyright notice and this permission notice (including the next paragraph) shall be included in all copies or substantial portions of the Software.

THE SOFTWARE IS PROVIDED "AS IS", WITHOUT WARRANTY OF ANY KIND, EXPRESS OR IMPLIED, INCLUDING BUT NOT LIMITED TO THE WARRANTIES OF MERCHANTABILITY, FITNESS FOR A PARTICULAR PURPOSE AND NONINFRINGEMENT. IN NO EVENT SHALL THE AUTHORS OR COPYRIGHT HOLDERS BE LIABLE FOR ANY CLAIM, DAMAGES OR OTHER LIABILITY, WHETHER IN AN ACTION OF CONTRACT, TORT OR OTHERWISE, ARISING FROM, OUT OF OR IN CONNECTION WITH THE SOFTWARE OR THE USE OR OTHER DEALINGS IN THE SOFTWARE.



---

## 7.13 Swashbuckle.AspNetCore

The MIT License (MIT)

Copyright (c) 2016 Richard Morris

Permission is hereby granted, free of charge, to any person obtaining a copy of this software and associated documentation files (the "Software"), to deal in the Software without restriction, including without limitation the rights to use, copy, modify, merge, publish, distribute, sublicense, and/or sell copies of the Software, and to permit persons to whom the Software is furnished to do so, subject to the following conditions:

The above copyright notice and this permission notice shall be included in all copies or substantial portions of the Software.

THE SOFTWARE IS PROVIDED "AS IS", WITHOUT WARRANTY OF ANY KIND, EXPRESS OR IMPLIED, INCLUDING BUT NOT LIMITED TO THE WARRANTIES OF MERCHANTABILITY, FITNESS FOR A PARTICULAR PURPOSE AND NONINFRINGEMENT. IN NO EVENT SHALL THE AUTHORS OR COPYRIGHT HOLDERS BE LIABLE FOR ANY CLAIM, DAMAGES OR OTHER LIABILITY, WHETHER IN AN ACTION OF CONTRACT, TORT OR OTHERWISE, ARISING FROM, OUT OF OR IN CONNECTION WITH THE SOFTWARE OR THE USE OR OTHER DEALINGS IN THE SOFTWARE.

---

## 7.14 Vite

### MIT License

Copyright (c) 2019-present, Yuxi (Evan) You and Vite contributors

Permission is hereby granted, free of charge, to any person obtaining a copy of this software and associated documentation files (the "Software"), to deal in the Software without restriction, including without limitation the rights to use, copy, modify, merge, publish, distribute, sublicense, and/or sell copies of the Software, and to permit persons to whom the Software is furnished to do so, subject to the following conditions:

The above copyright notice and this permission notice shall be included in all copies or substantial portions of the Software.

THE SOFTWARE IS PROVIDED "AS IS", WITHOUT WARRANTY OF ANY KIND, EXPRESS OR IMPLIED, INCLUDING BUT NOT LIMITED TO THE WARRANTIES OF MERCHANTABILITY, FITNESS FOR A PARTICULAR PURPOSE AND NONINFRINGEMENT. IN NO EVENT SHALL THE AUTHORS OR COPYRIGHT HOLDERS BE LIABLE FOR ANY CLAIM, DAMAGES OR OTHER LIABILITY, WHETHER IN AN ACTION OF CONTRACT, TORT OR OTHERWISE, ARISING FROM, OUT OF OR IN CONNECTION WITH THE SOFTWARE OR THE USE OR OTHER DEALINGS IN THE SOFTWARE.

---

## 7.15 WixSharp

The MIT License (MIT)

Copyright (c) 2016 oleg-shilo

Permission is hereby granted, free of charge, to any person obtaining a copy of this software and associated documentation files (the "Software"), to deal in the Software without restriction, including without limitation the rights to use, copy, modify, merge, publish, distribute, sublicense, and/or sell copies of the Software, and to permit persons to whom the Software is furnished to do so, subject to the following conditions:

The above copyright notice and this permission notice shall be included in all copies or substantial portions of the Software.

THE SOFTWARE IS PROVIDED "AS IS", WITHOUT WARRANTY OF ANY KIND, EXPRESS OR IMPLIED, INCLUDING BUT NOT LIMITED TO THE WARRANTIES OF MERCHANTABILITY, FITNESS FOR A PARTICULAR PURPOSE AND NONINFRINGEMENT. IN NO EVENT SHALL THE AUTHORS OR COPYRIGHT HOLDERS BE LIABLE FOR ANY CLAIM, DAMAGES OR OTHER LIABILITY, WHETHER IN AN ACTION OF CONTRACT, TORT OR OTHERWISE, ARISING FROM, OUT OF OR IN CONNECTION WITH THE SOFTWARE OR THE USE OR OTHER DEALINGS IN THE SOFTWARE.

---

## 7.16 Xunit

Apache License

Version 2.0, January 2004

<http://www.apache.org/licenses/>

### TERMS AND CONDITIONS FOR USE, REPRODUCTION, AND DISTRIBUTION

- 1. Definitions.
  - "License" shall mean the terms and conditions for use, reproduction, and distribution as defined by Sections 1 through 9 of this document.
  - "Licensor" shall mean the copyright owner or entity authorized by the copyright owner that is granting the License.
  - "Legal Entity" shall mean the union of the acting entity and all other entities that control, are controlled by, or are under common control with that entity. For the purposes of this definition, "control" means (i) the power, direct or indirect, to cause the direction or management of such entity, whether by contract or otherwise, or (ii) ownership of fifty percent (50%) or more of the outstanding shares, or (iii) beneficial ownership of such entity.
  - "You" (or "Your") shall mean an individual or Legal Entity exercising permissions granted by this License.
  - "Source" form shall mean the preferred form for making modifications, including but not limited to software source code, documentation source, and configuration files.
  - "Object" form shall mean any form resulting from mechanical transformation or translation of a Source form, including but not limited to compiled object code, generated documentation, and conversions to other media types.
  - "Work" shall mean the work of authorship, whether in Source or Object form, made available under the License, as indicated by a copyright notice that is included in or attached to the work (an example is provided in the Appendix below).
  - "Derivative Works" shall mean any work, whether in Source or Object form, that is based on (or derived from) the Work and for which the editorial revisions, annotations, elaborations, or other modifications represent, as a whole, an original work of authorship. For the purposes of this License, Derivative Works shall not include works that remain separable from, or merely link (or bind by name) to the interfaces of, the Work and Derivative Works thereof.
  - "Contribution" shall mean any work of authorship, including the original version of the Work and any modifications or additions to that Work or Derivative Works thereof, that is intentionally submitted to Licensor for inclusion in the Work by the copyright owner or by an individual or Legal Entity authorized to submit on behalf of the copyright owner. For the purposes of this definition, "submitted" means any form of electronic, verbal, or written communication sent to the Licensor or its representatives, including but not limited to communication on electronic mailing lists, source code control systems, and issue tracking systems that are managed by, or on behalf of, the Licensor for the purpose of discussing and improving the Work, but excluding communication that is conspicuously marked or otherwise designated in writing by the copyright owner as "Not a Contribution."
  - "Contributor" shall mean Licensor and any individual or Legal Entity on behalf of whom a Contribution has been received by Licensor and subsequently incorporated within the Work.

- 2. Grant of Copyright License. Subject to the terms and conditions of this License, each Contributor hereby grants to You a perpetual, worldwide, non-exclusive, no-charge, royalty-free, irrevocable copyright license to reproduce, prepare Derivative Works of, publicly display, publicly perform, sublicense, and distribute the Work and such Derivative Works in Source or Object form.
- 3. Grant of Patent License. Subject to the terms and conditions of this License, each Contributor hereby grants to You a perpetual, worldwide, non-exclusive, no-charge, royalty-free, irrevocable (except as stated in this section) patent license to make, have made, use, offer to sell, sell, import, and otherwise transfer the Work, where such license applies only to those patent claims licensable by such Contributor that are necessarily infringed by their Contribution(s) alone or by combination of their Contribution(s) with the Work to which such Contribution(s) was submitted. If You institute patent litigation against any entity (including a cross-claim or counterclaim in a lawsuit) alleging that the Work or a Contribution incorporated within the Work constitutes direct or contributory patent infringement, then any patent licenses granted to You under this License for that Work shall terminate as of the date such litigation is filed.
- 4. Redistribution. You may reproduce and distribute copies of the Work or Derivative Works thereof in any medium, with or without modifications, and in Source or Object form, provided that You meet the following conditions:
  - (a) You must give any other recipients of the Work or Derivative Works a copy of this License; and
  - (b) You must cause any modified files to carry prominent notices stating that You changed the files; and
  - (c) You must retain, in the Source form of any Derivative Works that You distribute, all copyright, patent, trademark, and attribution notices from the Source form of the Work, excluding those notices that do not pertain to any part of the Derivative Works; and
  - (d) If the Work includes a "NOTICE" text file as part of its distribution, then any Derivative Works that You distribute must include a readable copy of the attribution notices contained within such NOTICE file, excluding those notices that do not pertain to any part of the Derivative Works, in at least one of the following places: within a NOTICE text file distributed as part of the Derivative Works; within the Source form or documentation, if provided along with the Derivative Works; or, within a display generated by the Derivative Works, if and wherever such third-party notices normally appear. The contents of the NOTICE file are for informational purposes only and do not modify the License. You may add Your own attribution notices within Derivative Works that You distribute, alongside or as an addendum to the NOTICE text from the Work, provided that such additional attribution notices cannot be construed as modifying the License.  
You may add Your own copyright statement to Your modifications and may provide additional or different license terms and conditions for use, reproduction, or distribution of Your modifications, or for any such Derivative Works as a whole, provided Your use, reproduction, and distribution of the Work otherwise complies with the conditions stated in this License.
- 5. Submission of Contributions. Unless You explicitly state otherwise, any Contribution intentionally submitted for inclusion in the Work by You to the Licensor shall be under the terms and conditions of this License, without any additional terms or conditions. Notwithstanding the above, nothing herein shall supersede or modify the terms of any separate license agreement you may have executed with Licensor regarding such Contributions.
- 6. Trademarks. This License does not grant permission to use the trade names, trademarks, service marks, or product names of the Licensor, except as required for reasonable and customary use in describing the origin of the Work and reproducing the content of the NOTICE file.

- 7. Disclaimer of Warranty. Unless required by applicable law or agreed to in writing, Licensor provides the Work (and each Contributor provides its Contributions) on an "AS IS" BASIS, WITHOUT WARRANTIES OR CONDITIONS OF ANY KIND, either express or implied, including, without limitation, any warranties or conditions of TITLE, NON-INFRINGEMENT, MERCHANTABILITY, or FITNESS FOR A PARTICULAR PURPOSE. You are solely responsible for determining the appropriateness of using or redistributing the Work and assume any risks associated with Your exercise of permissions under this License.
- 8. Limitation of Liability. In no event and under no legal theory, whether in tort (including negligence), contract, or otherwise, unless required by applicable law (such as deliberate and grossly negligent acts) or agreed to in writing, shall any Contributor be liable to You for damages, including any direct, indirect, special, incidental, or consequential damages of any character arising as a result of this License or out of the use or inability to use the Work (including but not limited to damages for loss of goodwill, work stoppage, computer failure or malfunction, or any and all other commercial damages or losses), even if such Contributor has been advised of the possibility of such damages.
- 9. Accepting Warranty or Additional Liability. While redistributing the Work or Derivative Works thereof, You may choose to offer, and charge a fee for, acceptance of support, warranty, indemnity, or other liability obligations and/or rights consistent with this License. However, in accepting such obligations, You may act only on Your own behalf and on Your sole responsibility, not on behalf of any other Contributor, and only if You agree to indemnify, defend, and hold each Contributor harmless for any liability incurred by, or claims asserted against, such Contributor by reason of your accepting any such warranty or additional liability.

#### END OF TERMS AND CONDITIONS

#### APPENDIX: How to apply the Apache License to your work.

To apply the Apache License to your work, attach the following boilerplate notice, with the fields enclosed by brackets "[]" replaced with your own identifying information. (Don't include the brackets!) The text should be enclosed in the appropriate comment syntax for the file format. We also recommend that a file or class name and description of purpose be included on the same "printed page" as the copyright notice for easier identification within third-party archives.

Copyright [yyyy] [name of copyright owner]

Licensed under the Apache License, Version 2.0 (the "License");  
you may not use this file except in compliance with the License.  
You may obtain a copy of the License at

<http://www.apache.org/licenses/LICENSE-2.0>

Unless required by applicable law or agreed to in writing, software distributed under the License is distributed on an "AS IS" BASIS, WITHOUT WARRANTIES OR CONDITIONS OF ANY KIND, either express or implied. See the License for the specific language governing permissions and limitations under the License.